

ARTI 03 – nadstawka 63

ARTI 03 – aufsatz 63

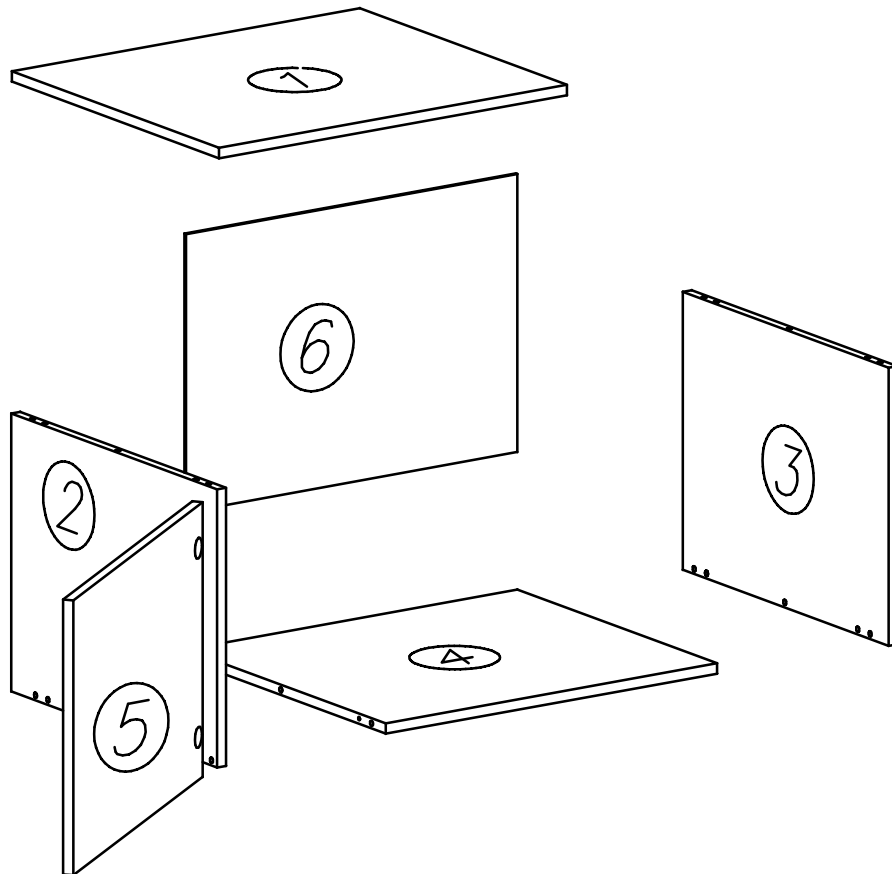

N15  
M4x25 x2

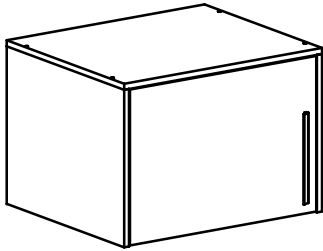
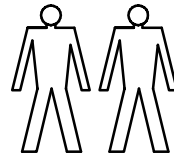
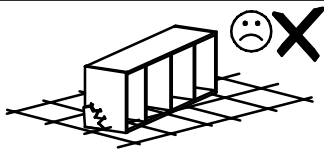
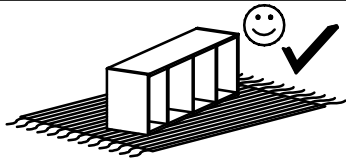
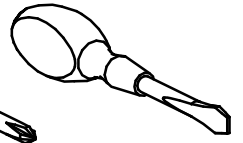
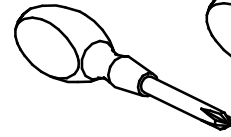
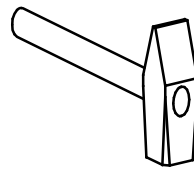

E13  
x1



W4  
x25

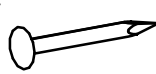

K5  
x4

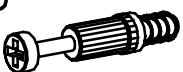

W2  
4mm x1

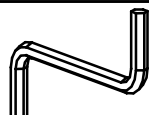

G4  
4x16 x4



G3  
4x30 x2

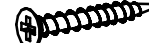

K1  
ø15x12 x4



B1  
ø8x35 x12



A1  
ø7x50 x4



C4  
Z350D x2



D4  
PZ350D x2



