

IBIS TYP7

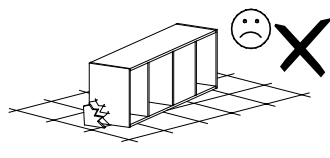

Narzędzia potrzebne do montażu

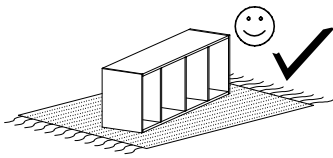
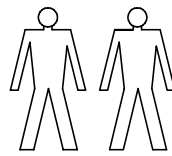
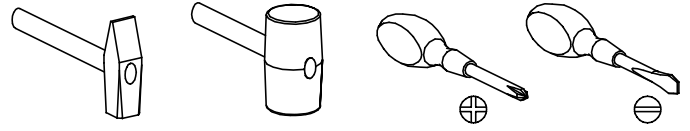

UWAGA !!!

MONTOWANIE USZKODZONYCH
ELEMENTÓW POWODUJE UTRATĘ
GWARANCJI

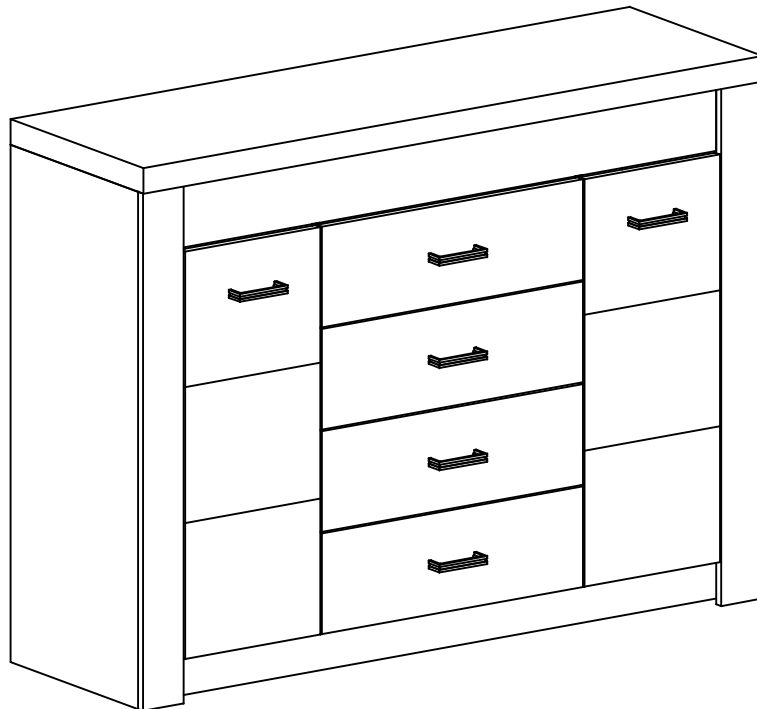

Nr	D[mm]	S[mm]	G[mm]	Ilość
1	1370	422	48	1
2	885	403	16	1
3	885	403	16	1
4	1337	403	16	1
5	1337	80	16	1
6	1337	123	16	1
7	983	403	16	1
8	983	403	16	1
9	983	80	16	1
10	983	80	16	1
11	380	340	16	2
12	635	190	16	4
13	350	150	16	4
14	350	150	16	4
15	560	150	16	4
16	590	355	2,5	4
17	947	363	2,5	2
18	947	316	2,5	2
19	772	280	16	1
20	772	280	16	1

UWAGA !!!

Mebel zawiera
elementy drewniane

W przypadku reklamacji proszę podać numer pakowacza znajdujący się na kartonie.



S - 8 St.



I - 2 St.

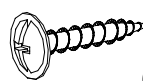

Q - 4 St.
3,5x16 mm

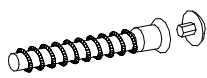

A - 5 St.

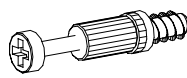

K - 18 St.

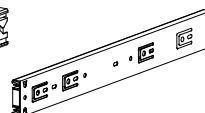
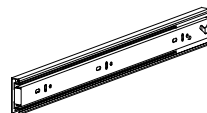

T - 4 Kpl.



J - 32 St.
5.13 mm

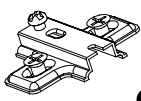

C - 4 St.

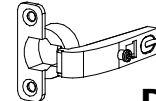

D - 4 St.

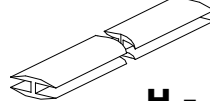

H - 1 St.



Y - 16 St.



M - 65 St.
3x30 mm

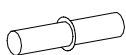

F - 8 St.



Z - 1 St.



U - 6 St.

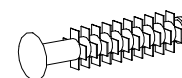

P - 16 St.

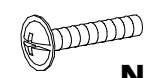

N - 12 St.
4x25 mm

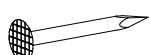

E - 80 St.



B - 44 St.

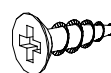

G - 24 St.
3,5x16 mm

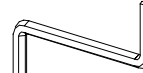

Z - 1 St.



L - 18 St.

I

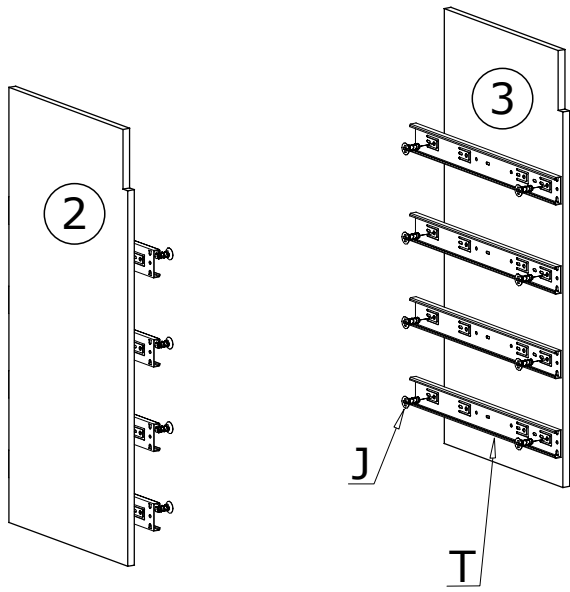

II

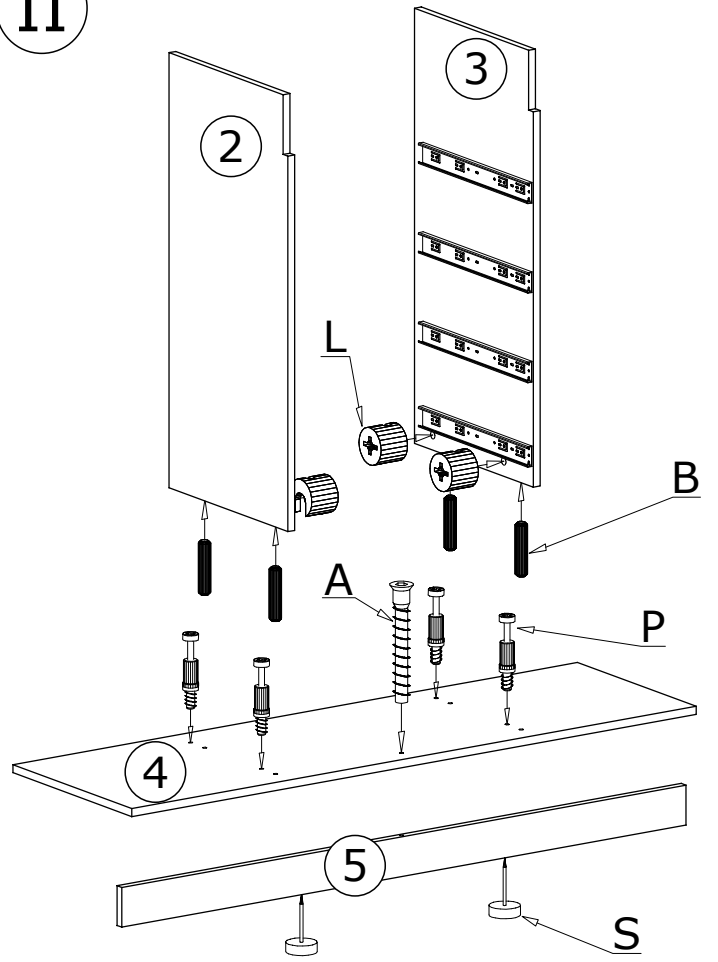

III

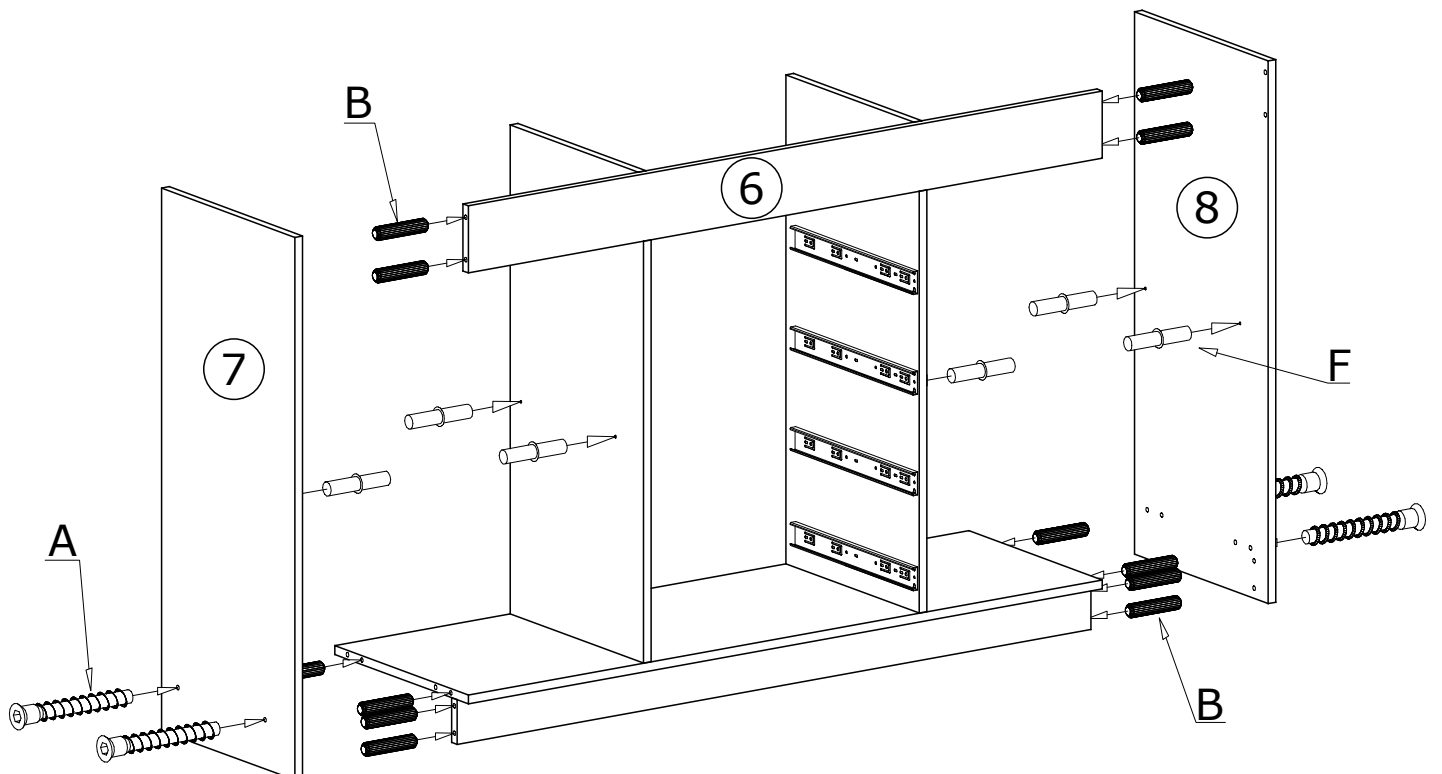

V

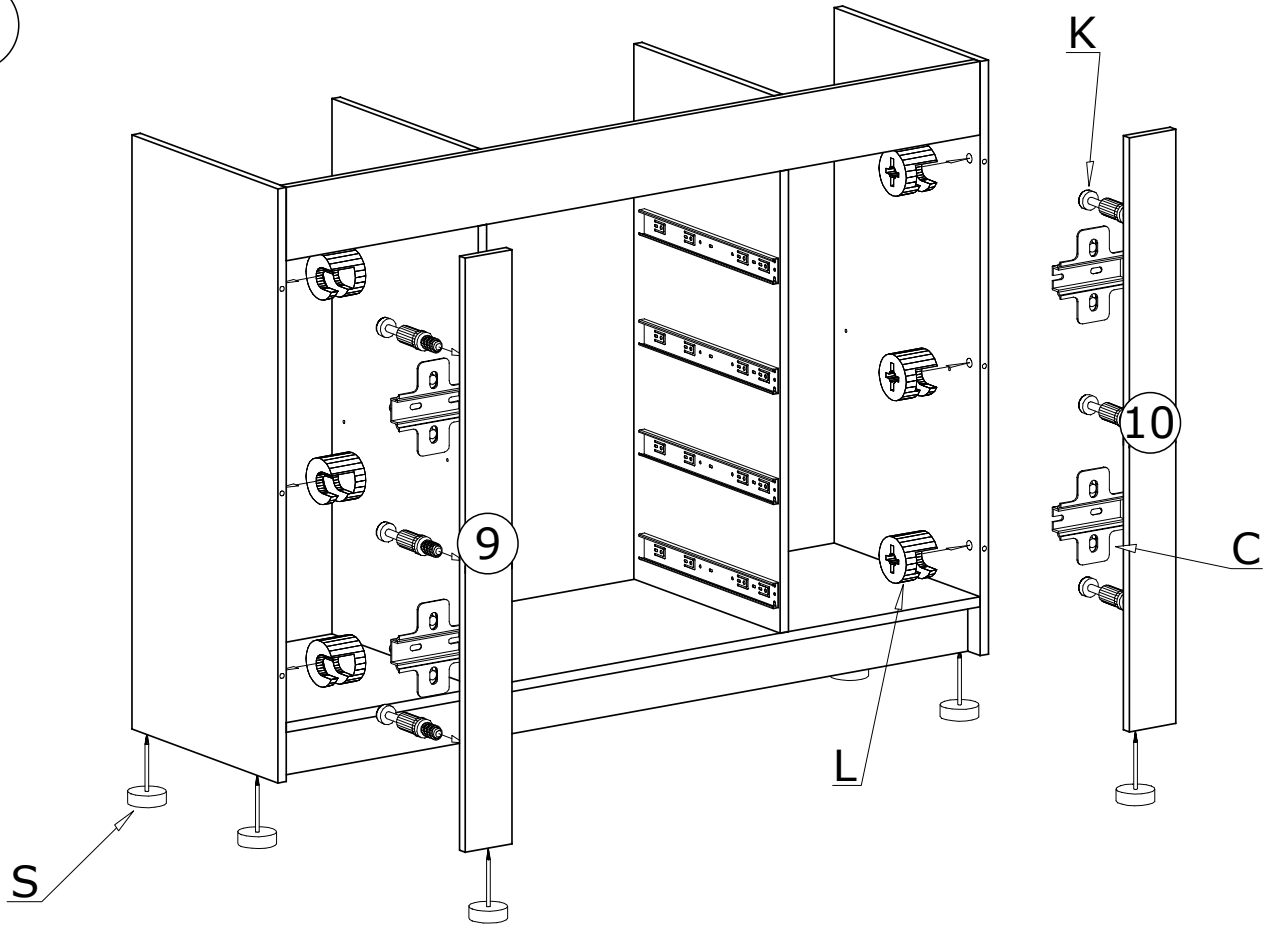

IV

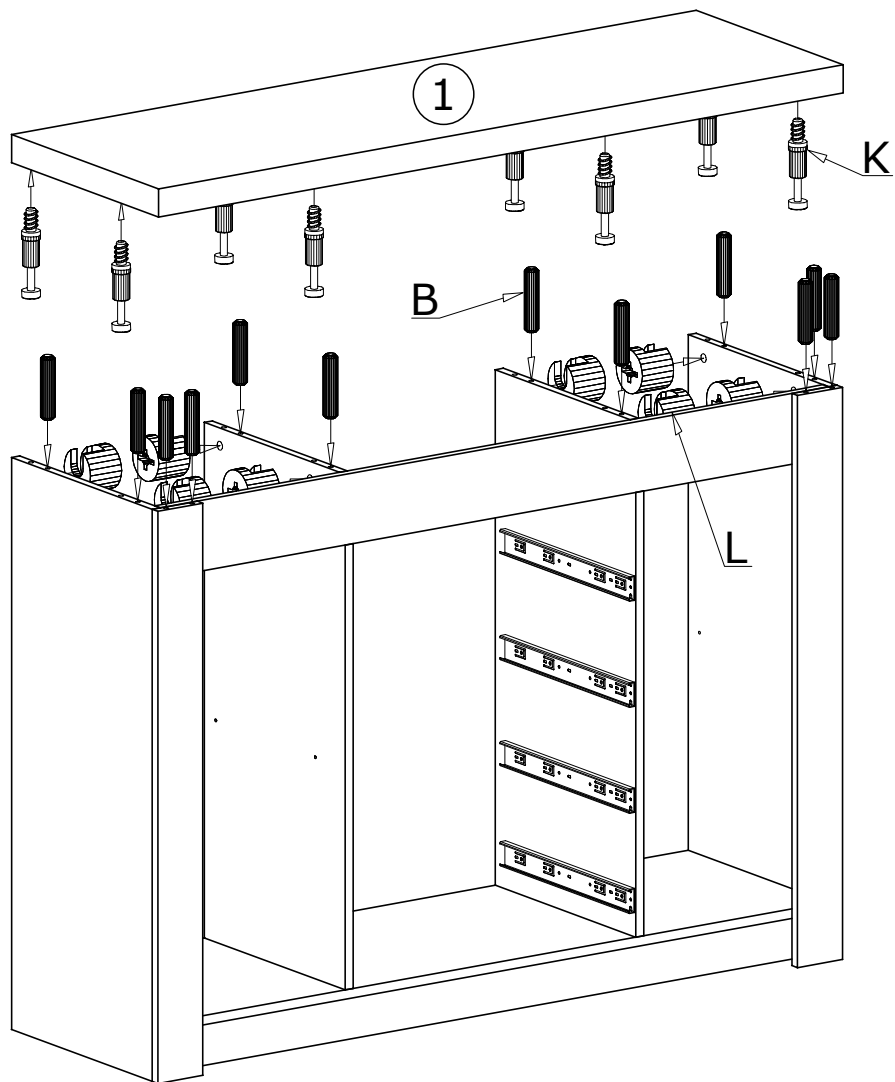

VI

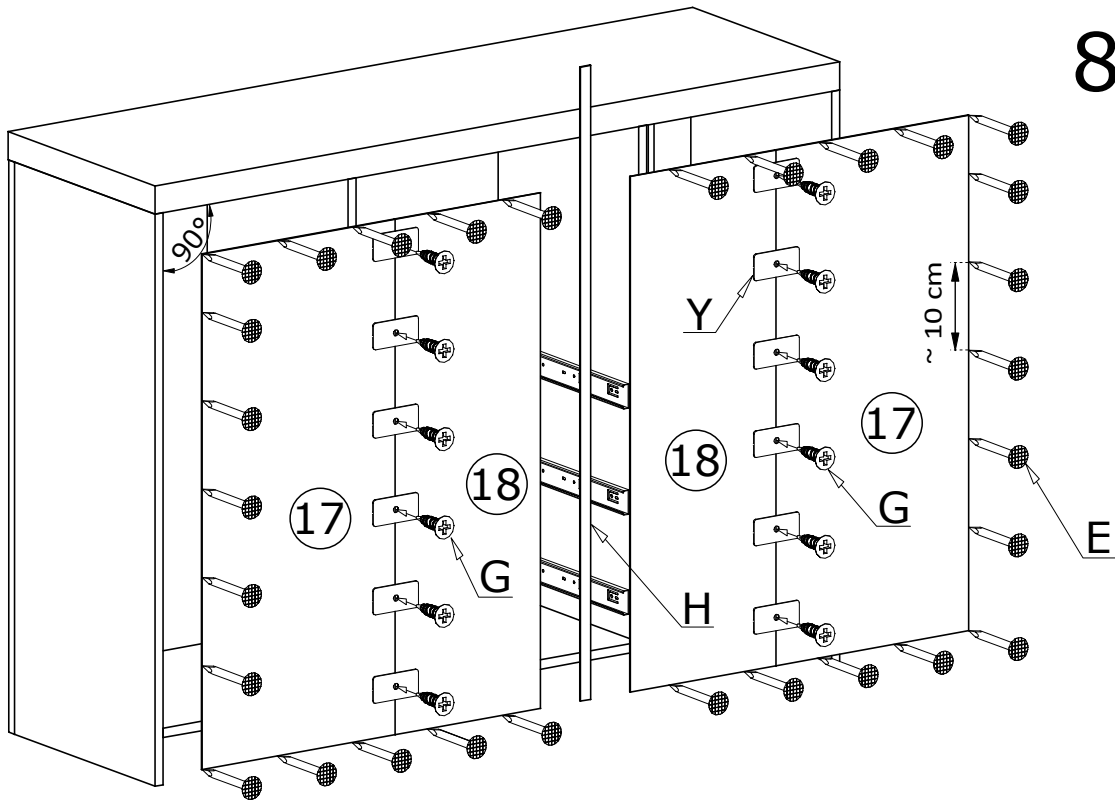

80X

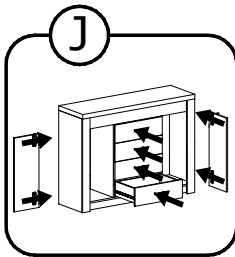
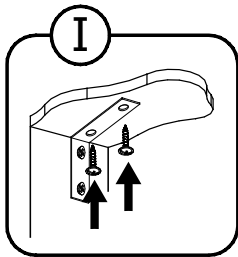
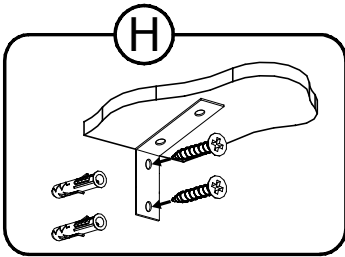
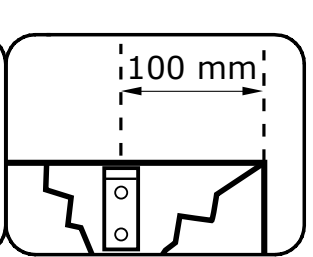
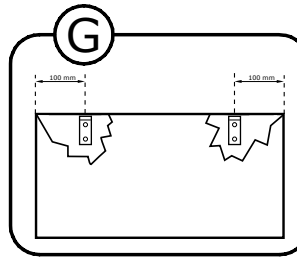
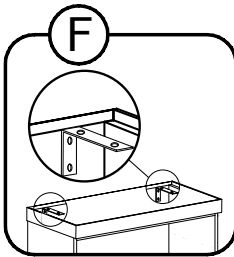
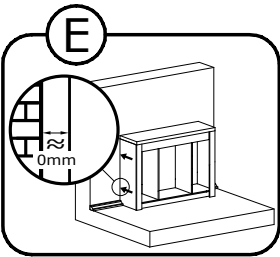
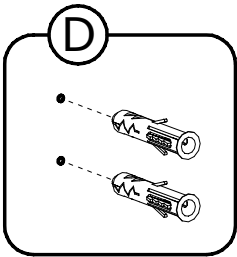
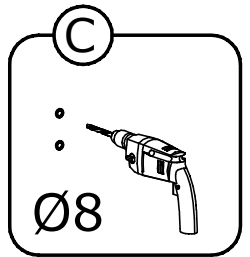
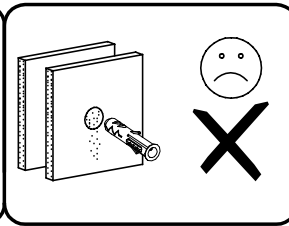
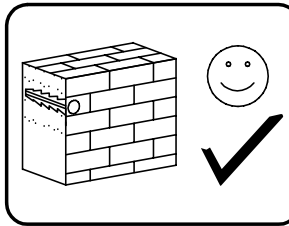
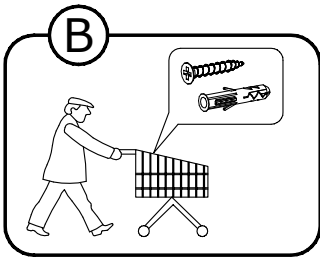
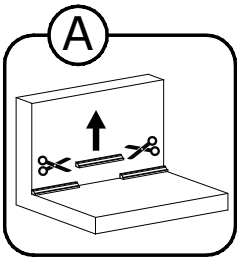

Meble zawierają elementy drewniane, których barwa i układ słoju są uzależnione od wielu czynników, dlatego mogą występować różnice w fakturze i barwie co nie stanowi wady produktu i nie wpływa na jego jakość, trwałość i funkcjonalność.

Listwy drewniane mogą ujawniać niewielkie zmiany w kształcie i wymiarach wywołane specyficznymi warunkami eksploatacji takimi jak: wilgotność, różnice temperatur, etc.

VII

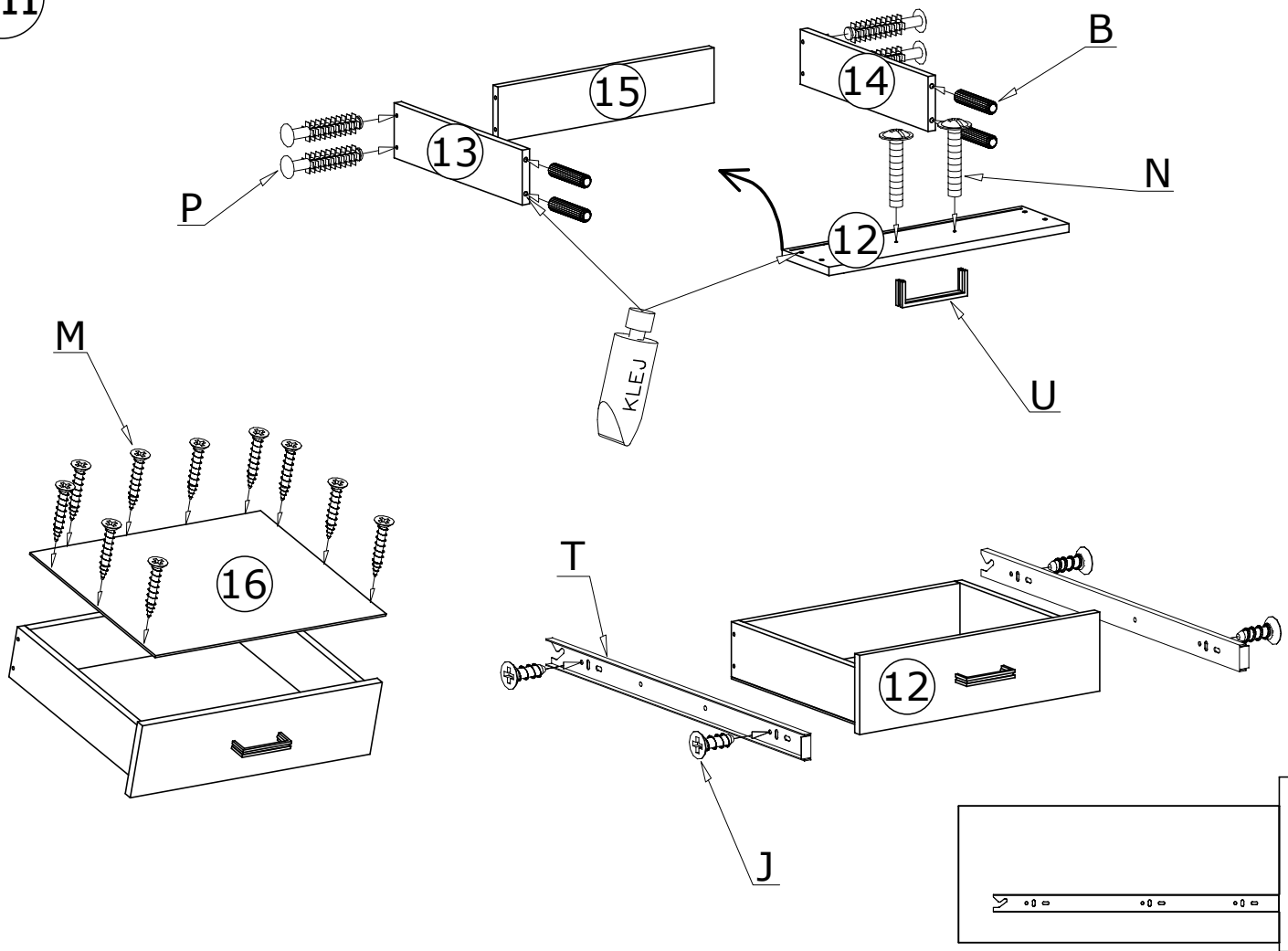

VIII

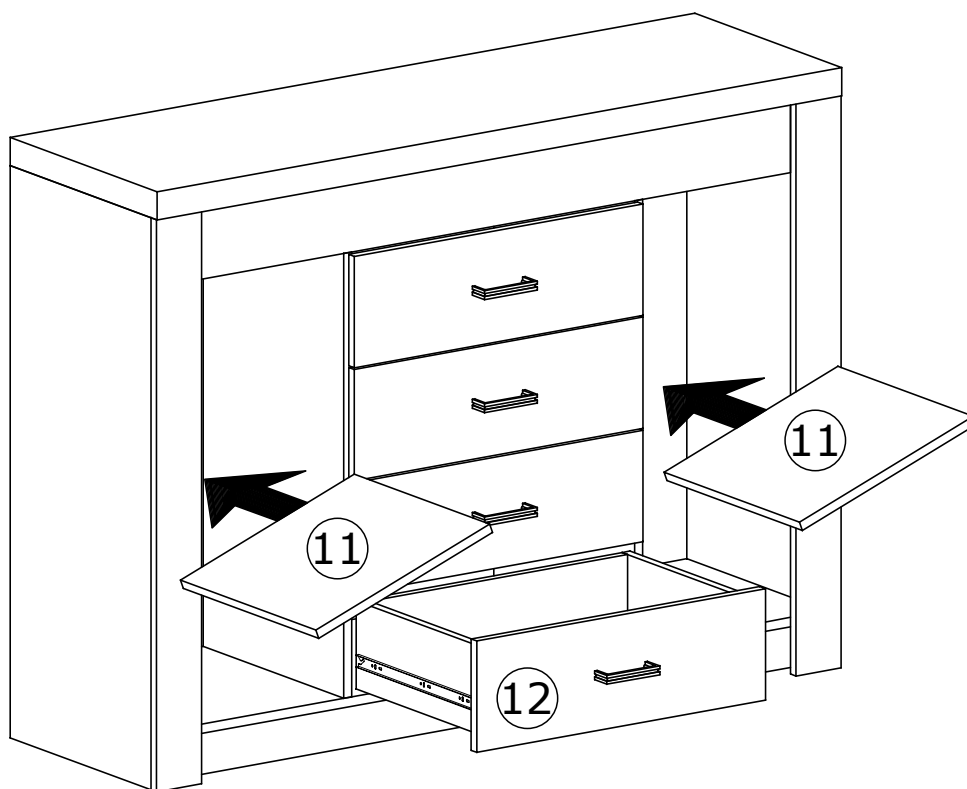

IX

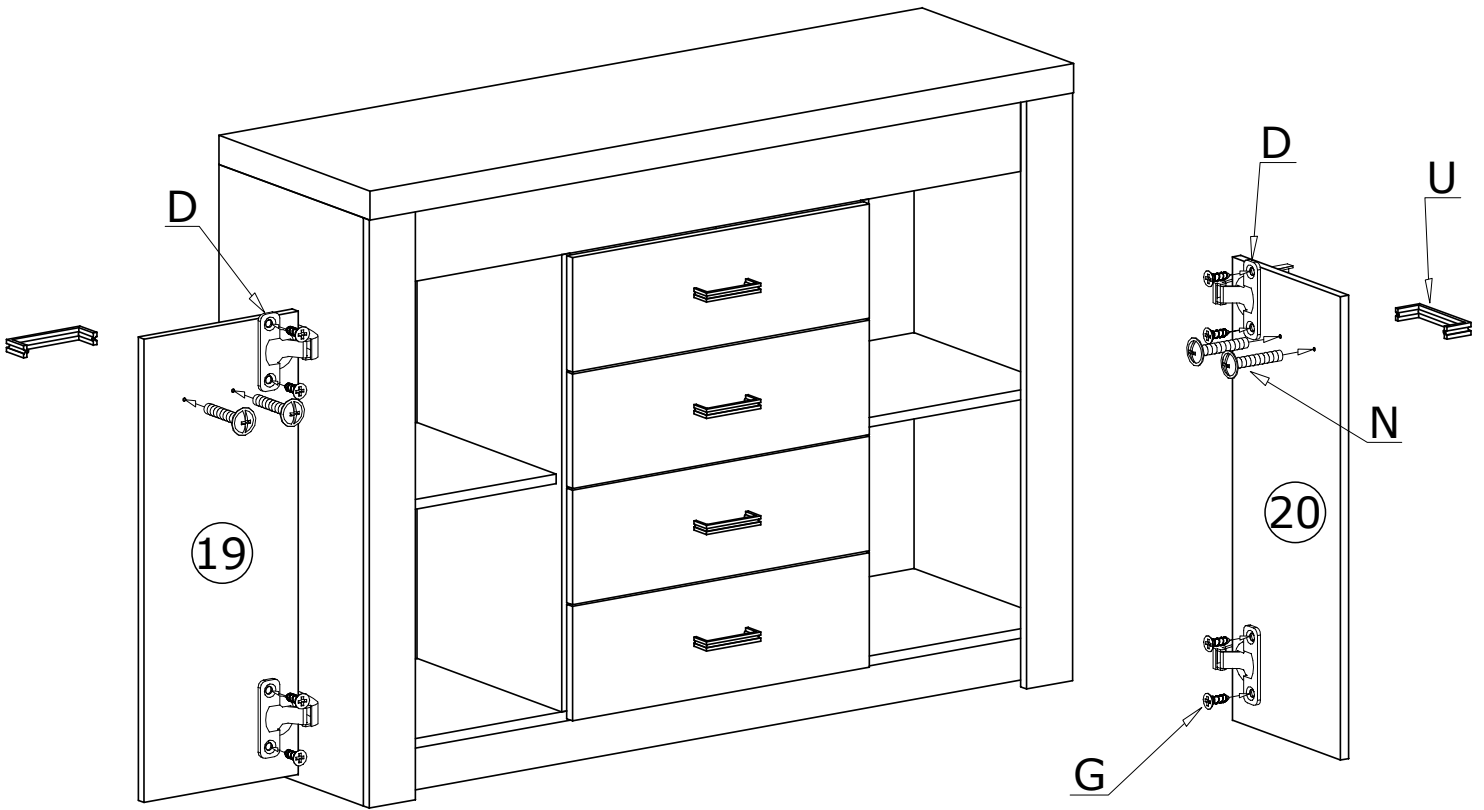

MONTAŻ/DEMONTAŻ PROWADNIC

1



2

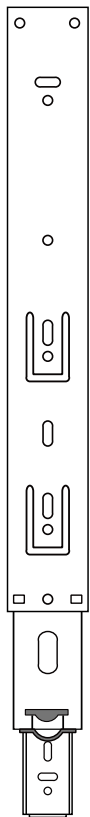

3

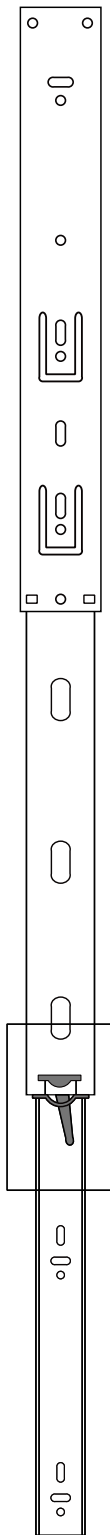

4

