

Szafa DO-24, ML-24, N-24, CON-24 SYSTEMU SzaFA-DOME

INSTRUKCJA MONTAŻU, KONSERWACJI, UŻYTKOWANIA I GWARANCJA

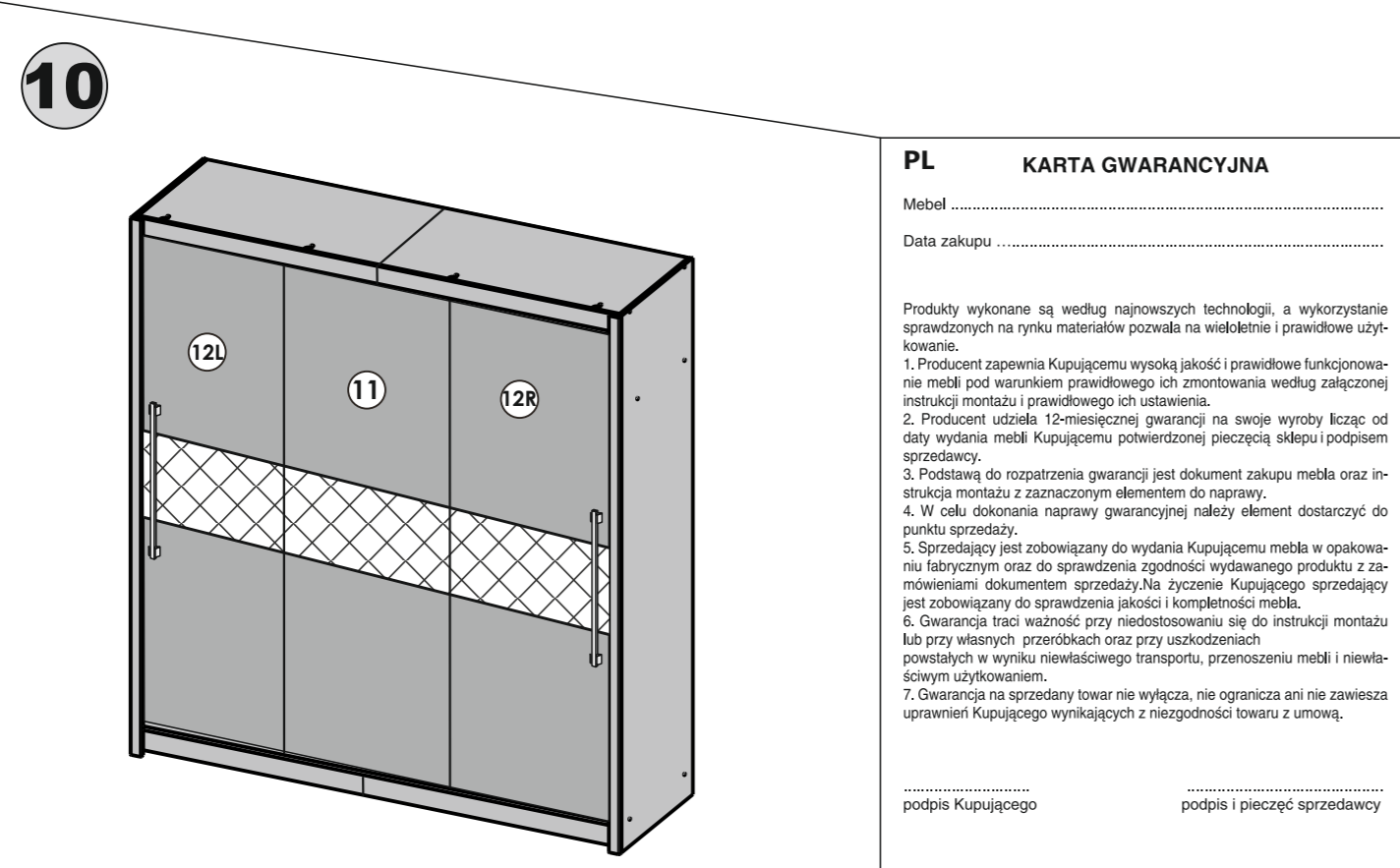

- PL** INSTRUKCJA MONTAŻU SZAFY DO-20
- HU** ÖSSZESZERELÉSI ÚTMUTATÓ SZEKRÉNY DO-20
- CZ** NÁVOD K MONTÁŽI SKŘÍŇ DO-20
- SK** MONTÁŽNE POKYNY SKRIŇA DO-20
- RO** INSTRUCȚIUNE DE MONTAJ DULAP DO-20
- RU** ИНСТРУКЦИЯ ПО СБОРКЕ ШКАФ DO-20
- BY** ИНСТРУКЦІЯ ЗА МОНТАЖ ГАРДЕРОБ DO-20

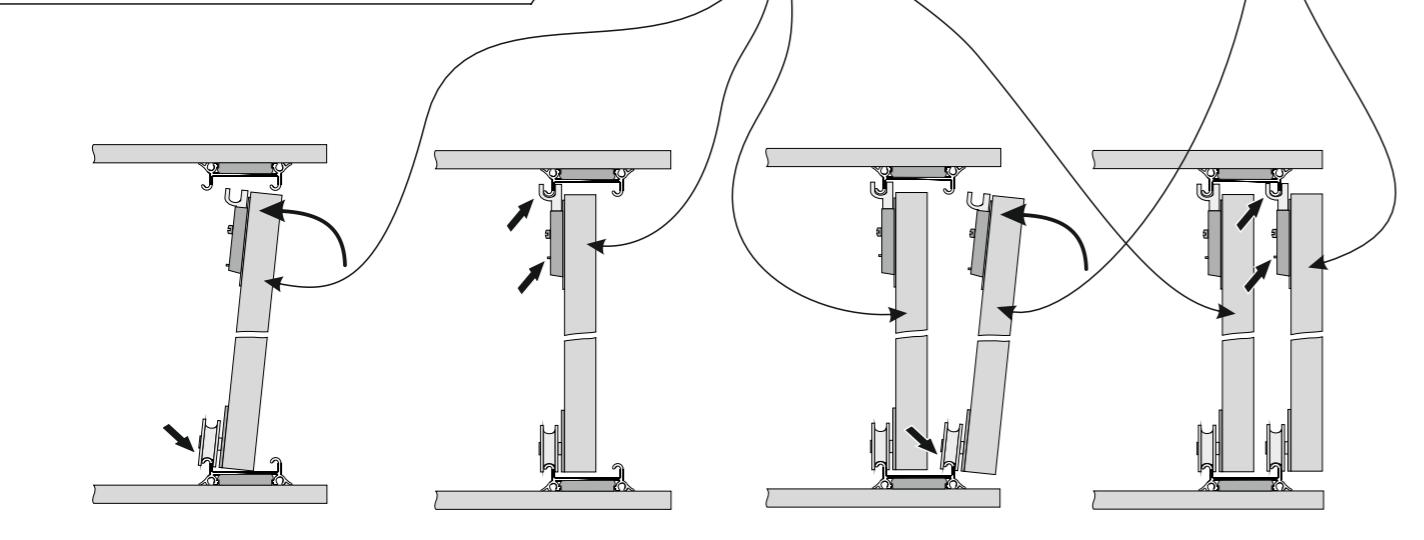
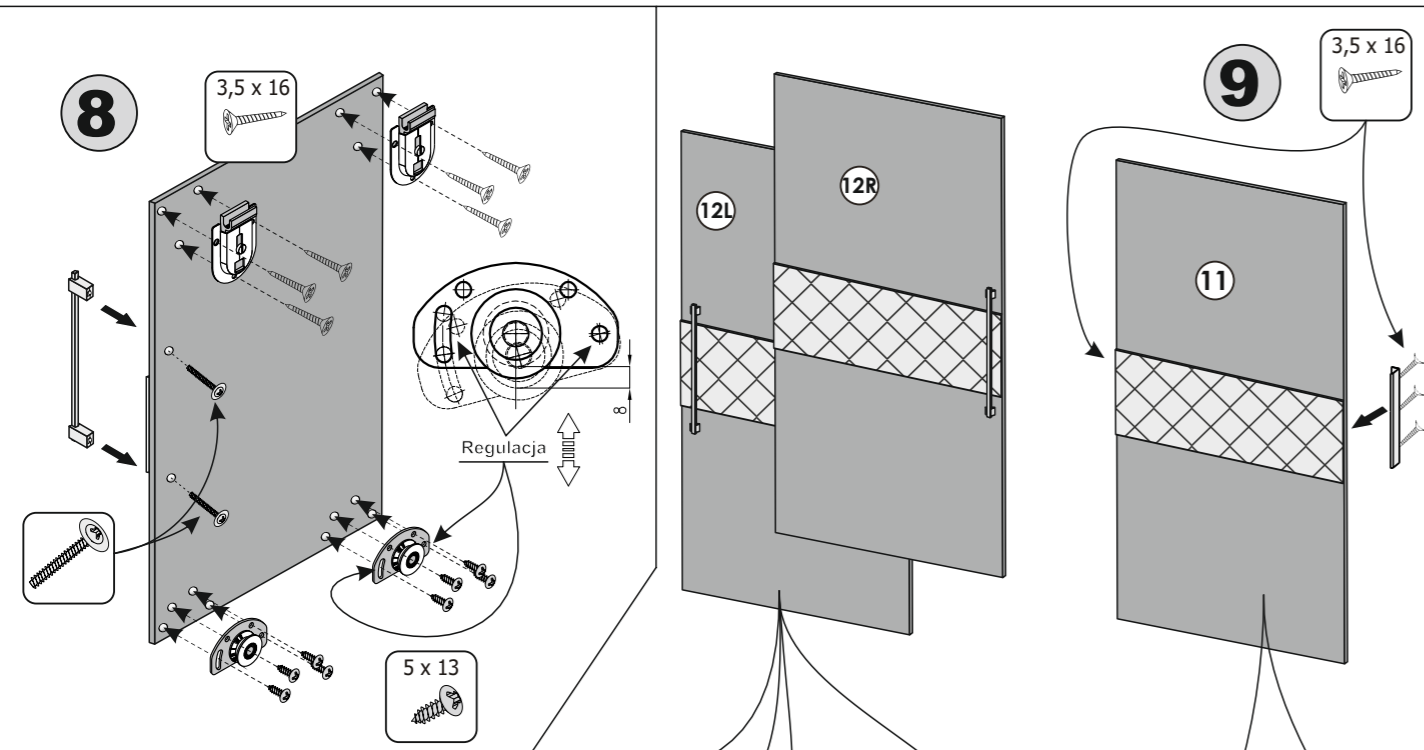
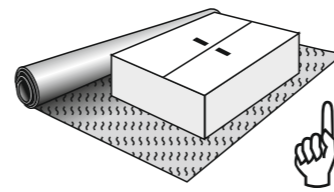



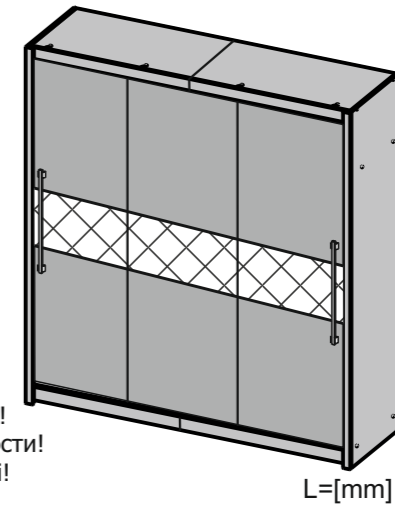



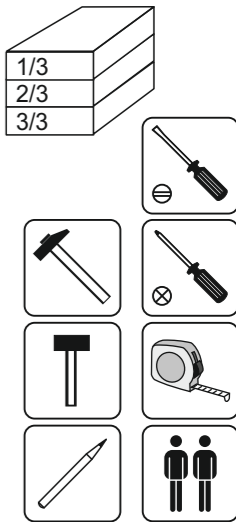

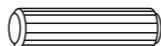









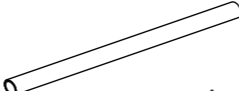
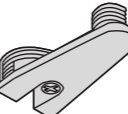

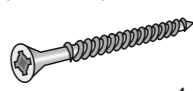
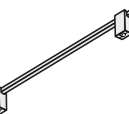

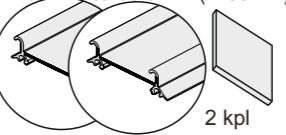

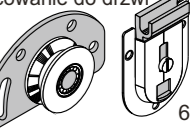

- PL** Montaż na miękkim podłożu!
- HU** Szerelít puha felületre!
- CZ** Montáž na měkkém povrchu
- SK** Montáž na mäkkom povrchu!
- RO** Montat pe o suprafață moale!
- RU** Сборка на мягкой поверхности!
- BY** Мантаж на мяккай паверхні!

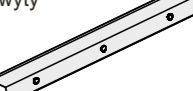

L=[mm]



kołek ø 8 x 30  36 szt.	konfirmat  28 szt.	zaślepka konfirmatu  28 szt.	Stopka z gwoździem  12 szt.	klucz imbusowy  1 szt.
listwa "H" 2015mm  1 szt.	uchwyt drążka  1 kpl.	gwoździe  110 szt.	blaszki  40 szt.	podpórka do półki  24 szt.
drążek szafy (982mm)  1 szt.	pasat  6 szt.	trzcienie do pasata  6 szt.	wkręt do uchwytów  4 szt.	Uchwyty  2 szt.
klej  2 szt.	lamelka  12 szt.	Prowadnica do drzwi (1183mm)  2 kpl.	plastikowe krawki do mocowania prowadnicy  12 szt.	mocowanie do drzwi  6 kpl.
Wkręt 5 x 13  24 szt.	Wkręt 3,5 x 16 (z podkładką)  12 szt.	wkręty 3,5 x 16  24 szt.	Uchwyty  2 szt.	wkręty do odbojników 4 x 20  4 szt.
kołek ø 8 x 40  36 szt.	mimośród  18 szt.	zaślepka mimośroda  18 szt.	Trzcienie dwustronny 46mm  9 szt.	

PL W przypadku reklamacji prosimy o podanie: nazwy systemu, nazwy elementu systemu, numeru paczki i numeru uszkodzonego lub brakującego detalu. Np. System MARGOT, szafa M1, paczka 1/2, detal 4.

HU Reklamáció esetén kérjük megadni: a rendszer neve, a rendszerelem neve, a csomag száma és a sérült vagy hiányzó részlet száma. Pl. MARGOT rendszer, szekrény M1, csomag 1/2, 4-es számú elem.

CZ V případě reklamace prosíme o uvádění: názvu systému, názvu elementu systému, číslo balíku a číslo poškozeného nebo chybějícího detailu. Např. Systém MARGOT, skříň M1, balík 1/2, č. detailu 4.

SK V prípade reklamácie uvedte: názov systému, názvy systémových prvkov, číslo balíka a číslo poškodenej alebo chýbajúcej časti. Napr. Systém MARGOT, skriňa M1, balík 1/2, č. časti: 4.

RO În cazul reclamației vă rugăm să precizați: denumirea sistemului, denumirea elementului sistemului, numărul pachetului și numărul detaliului deteriorat sau lipsit. De exemplu: Sistem MARGOT, dulap M1, pachet 1/2, nr. detaliu 4.

RU В случае рекламации укажите: название системы, название элемента системы, номер упаковки и номер поврежденной или отсутствующей части. Например: Система MARGOT, шкаф M1, упаковка 1/2, номер детали 4.

BY У выпадку прад'яўлення рэкламацыі, калі ласка, падайце: назву сістэмы, назву элемента сістэмы, нумар упакоўкі і нумар пашкоджанай або адсутнай дэталі. Напрыклад: Система MARGOT, шкаф M1, упакоўка 1/2, № дэталі 4.

- PL** widok od spodu **SK** pohľad zdola
- HU** alulnézet **RO** vedere de jos
- CZ** pohled ze spodu **RU** вид снизу

SzaFA-DOME DO-24

