

# MARKUS

## MK 150

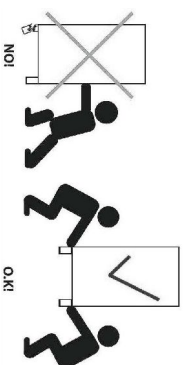
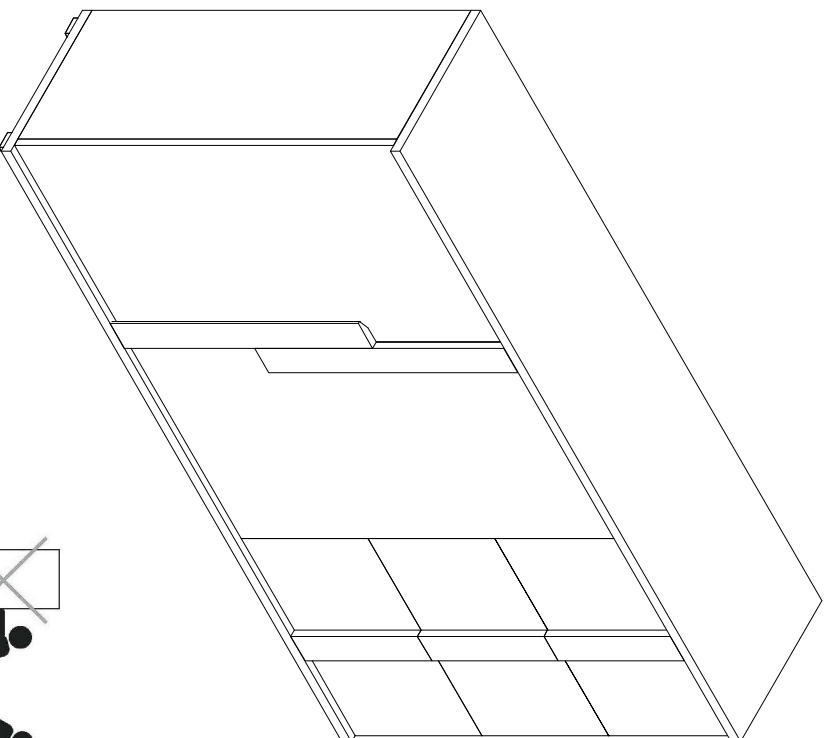

22.03.2016

- (D) Montageanleitung
- (FR) Notice de montage
- (NL) Handleiding voor de montage
- (CZ) Montážní návod
- (HU) Szerelési útmutató
- (TR) Montaj talimatı
- (GB) Assembly Instructions
- (IT) Istruzioni di montaggio
- (PL) Instrukcja montażu
- (SK) Návod na montáž
- (RO) Instrucțiunile de montaj
- (RU) Инструкции по монтажу

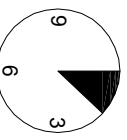
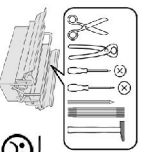

1-1,5

1

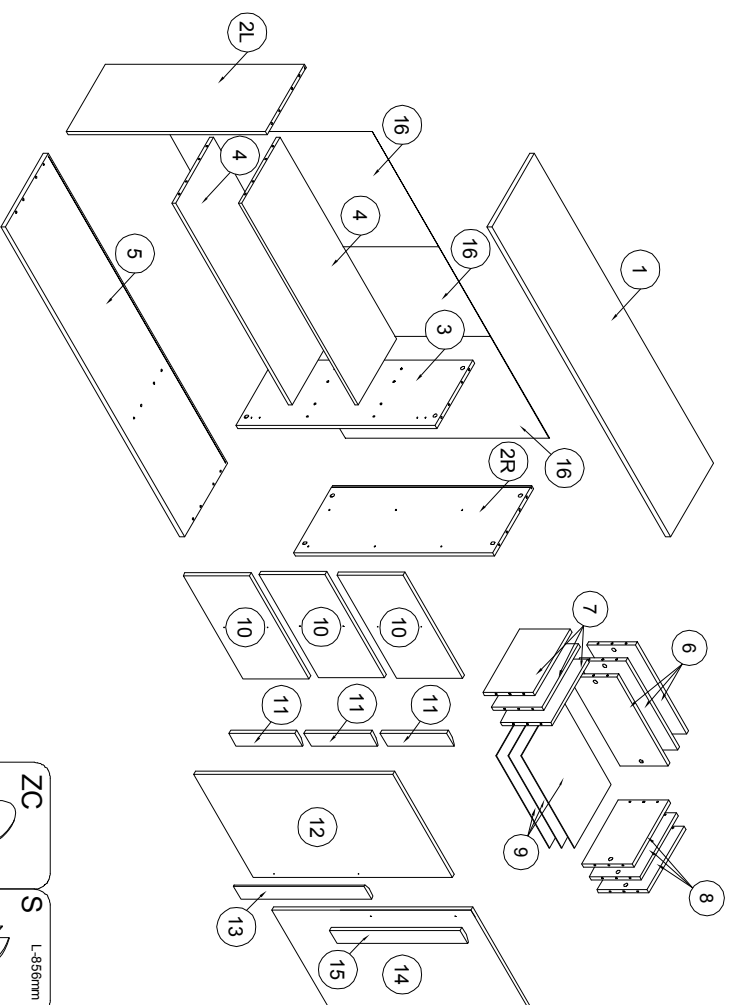

NF 4x30 X10	HA M4x20 X6	X X10	N 3x20 X22	Y X5	P 1/2 X2	ZC X5	S L-856mm X1
B X32	C X32	Z X32	A 8x32 X44	F2 3x2 X6	NA 4x13 X26	R X2	H 6,3x13 X8

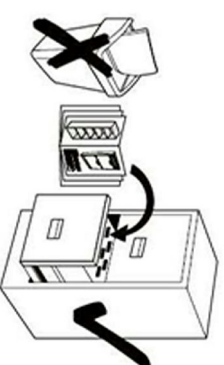
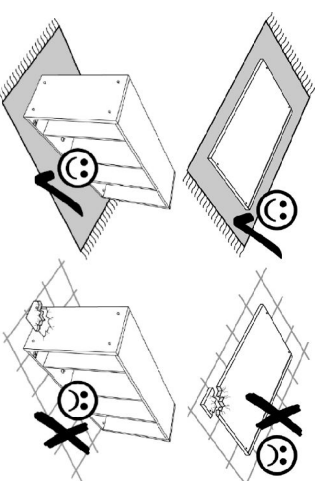

2

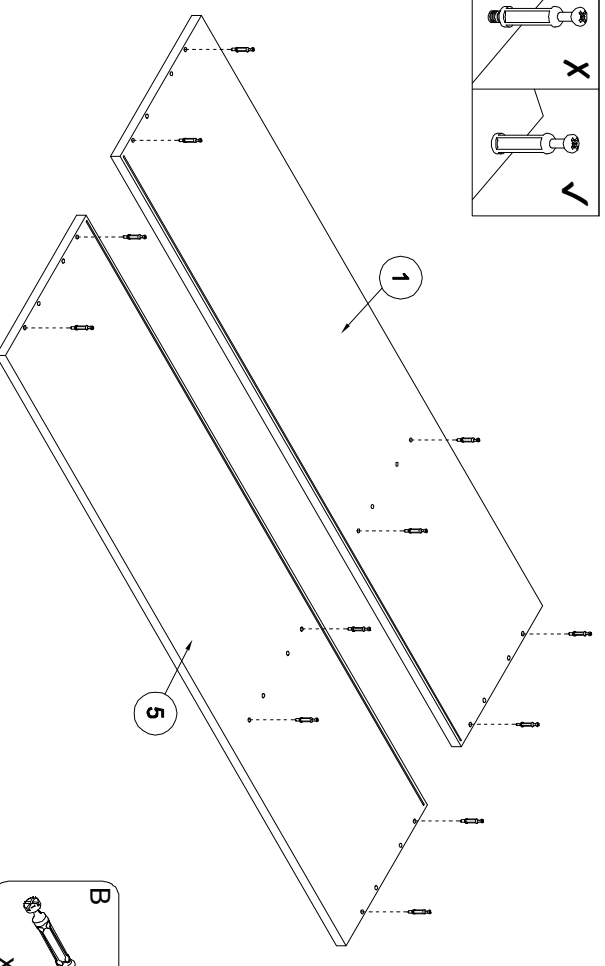
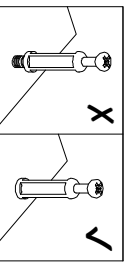

3

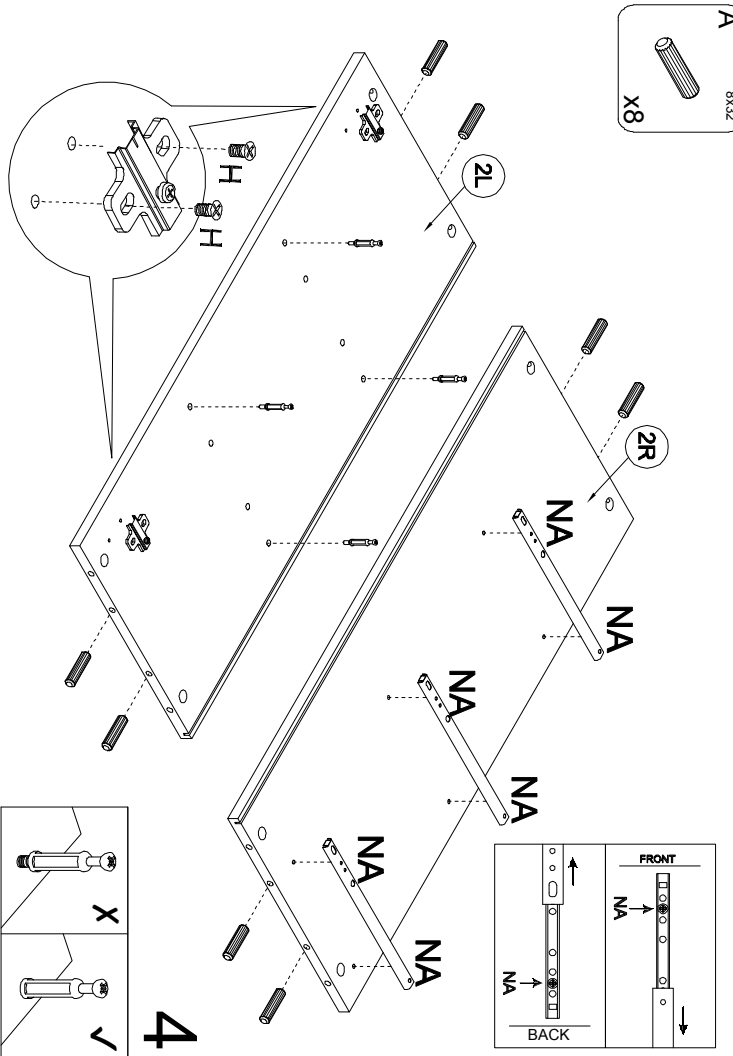
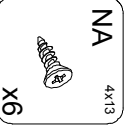
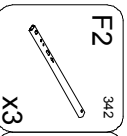
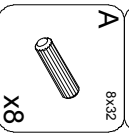
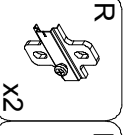
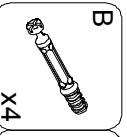
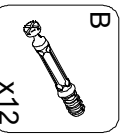

4

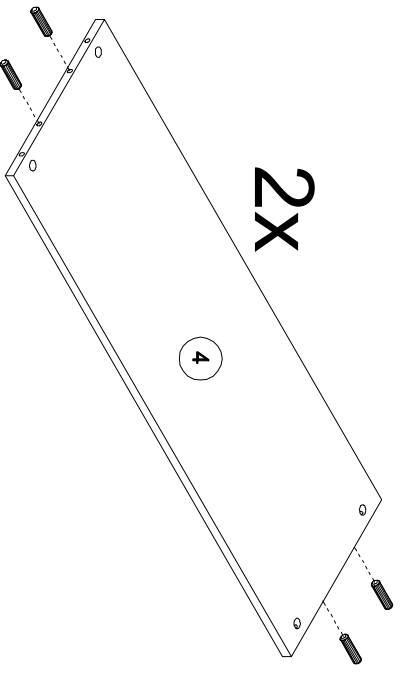
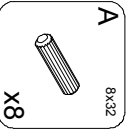

5

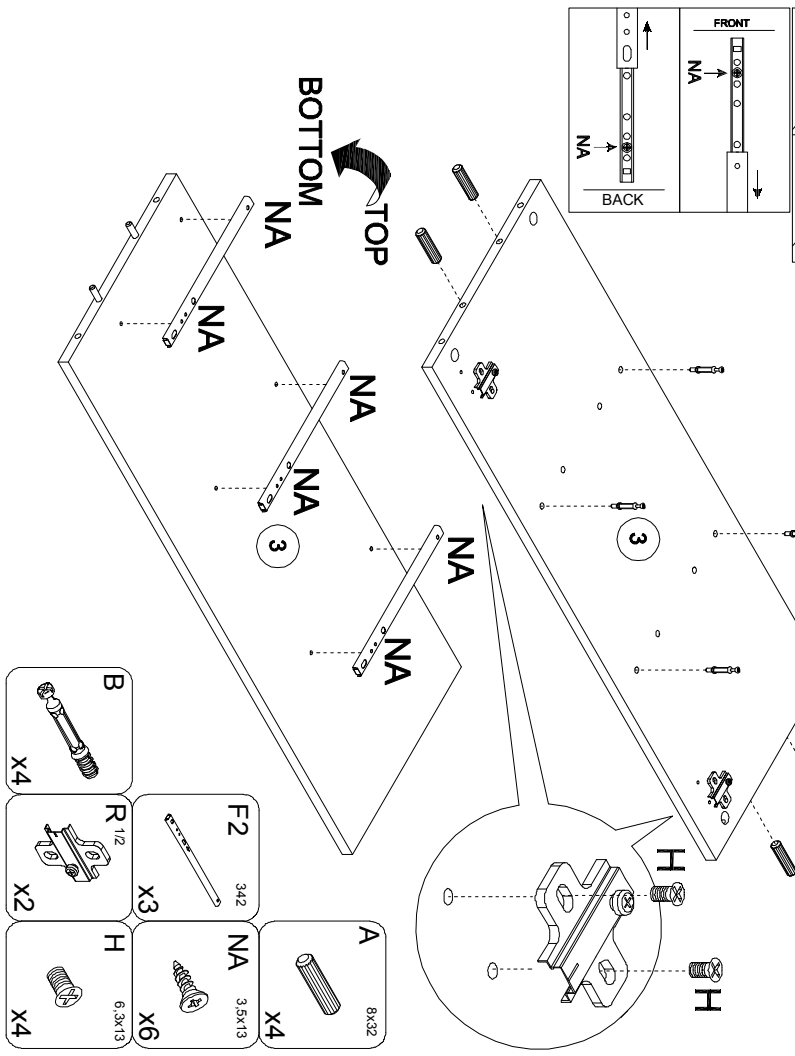
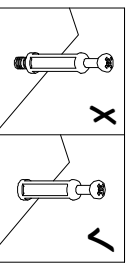

6

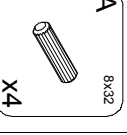
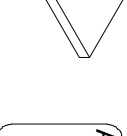
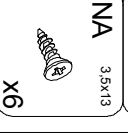
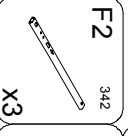
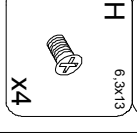
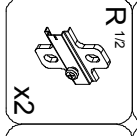
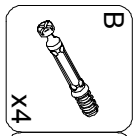

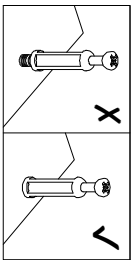

7

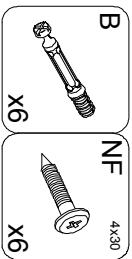
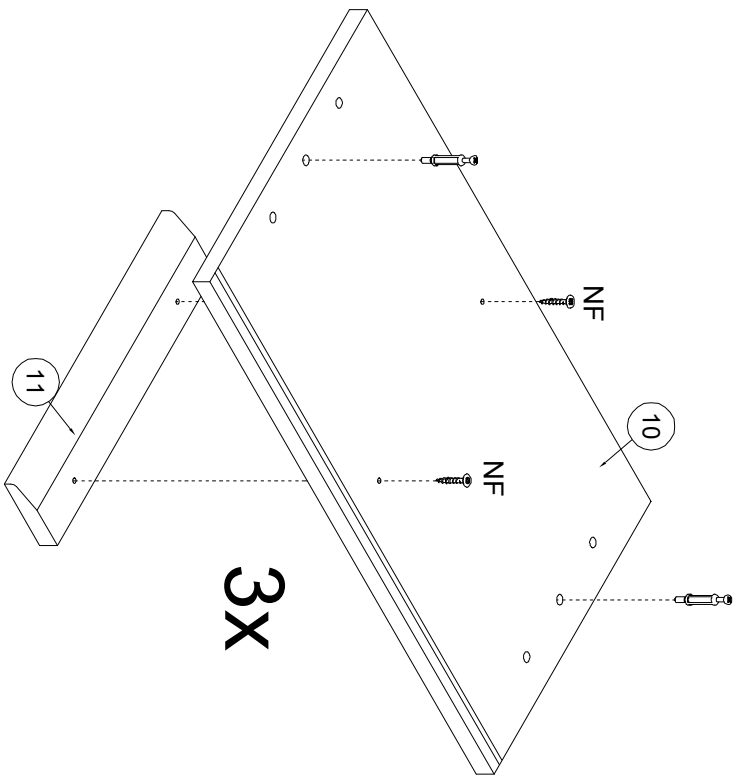

8

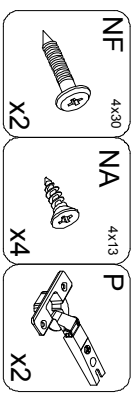
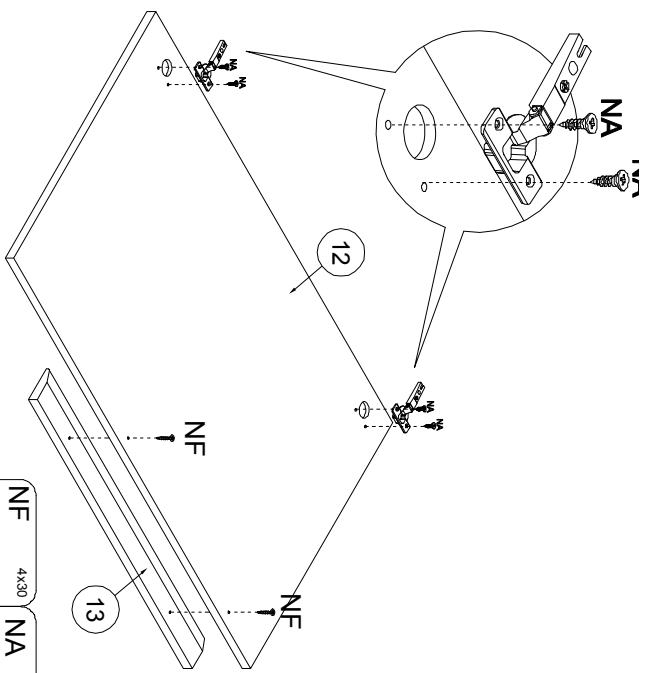

9

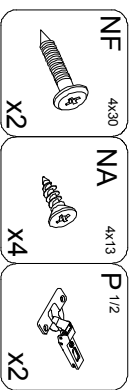
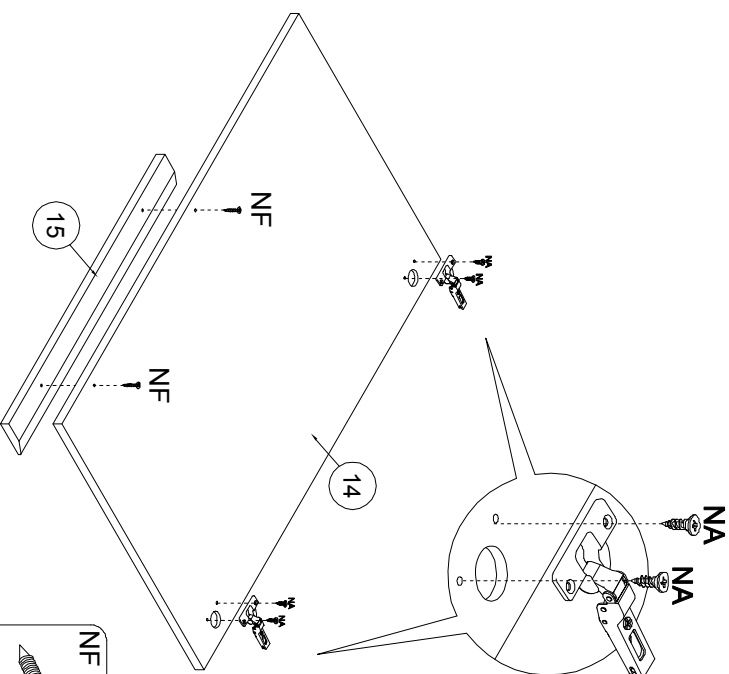

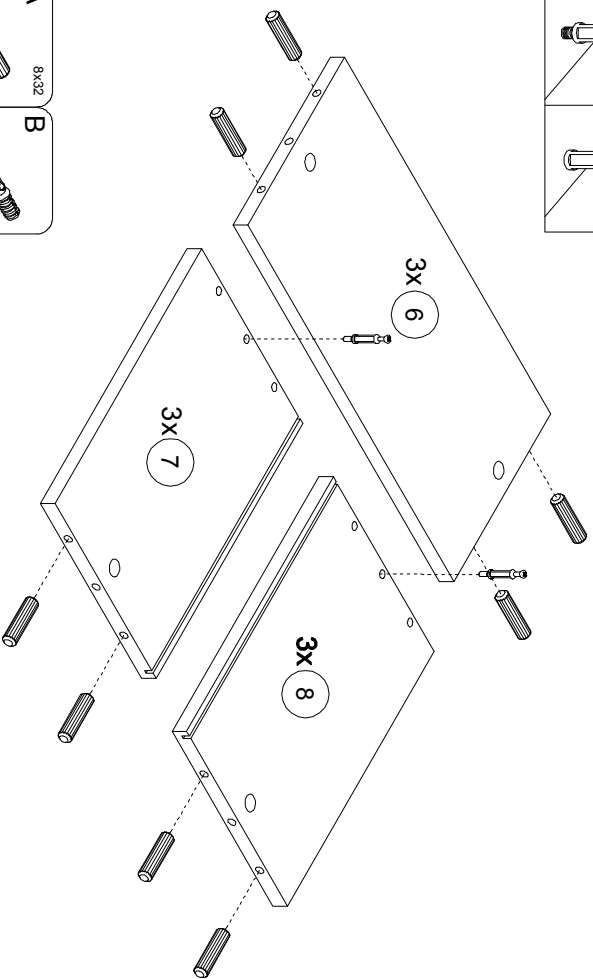
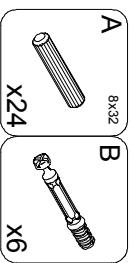
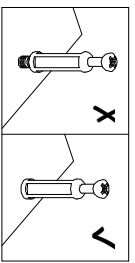

10

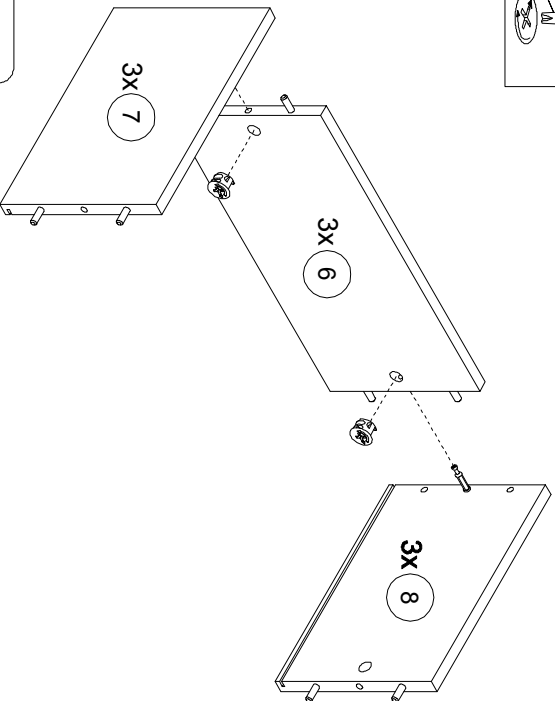
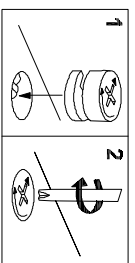

11

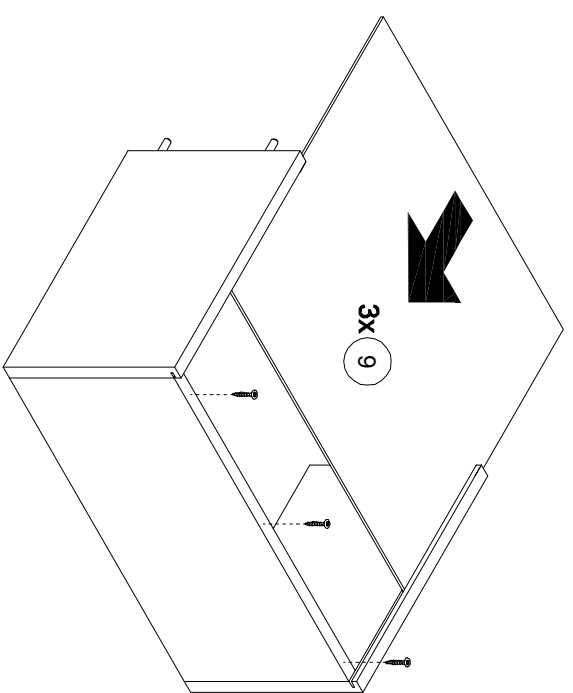
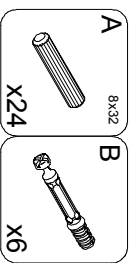
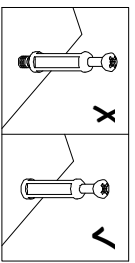

12

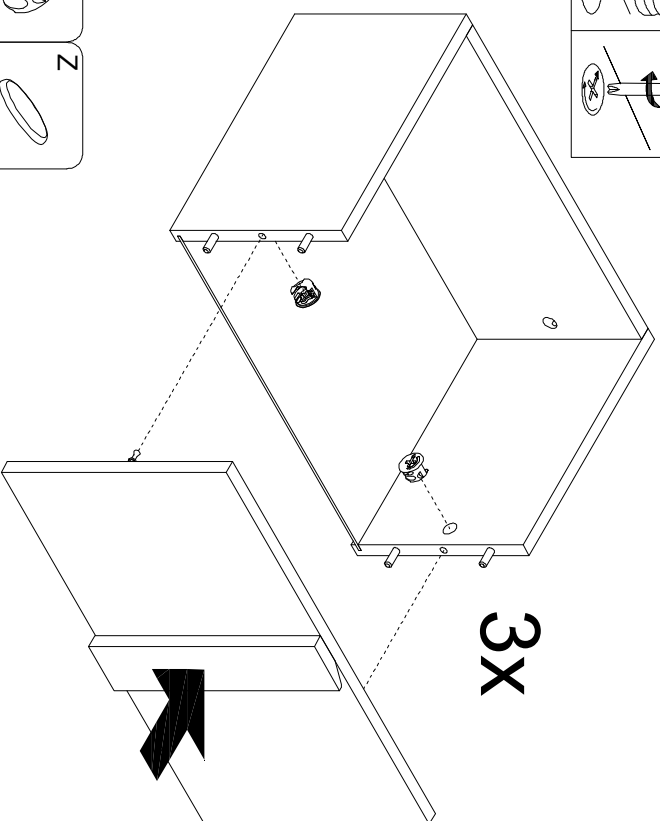
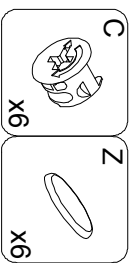
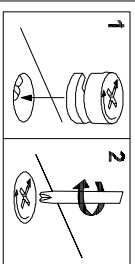

13



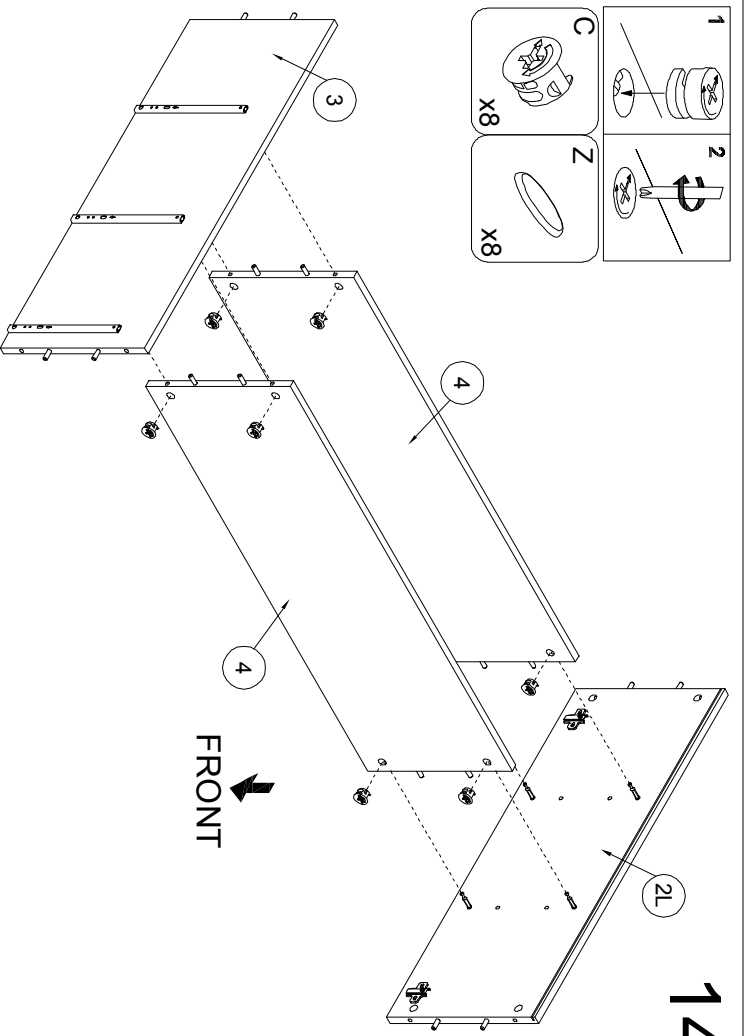
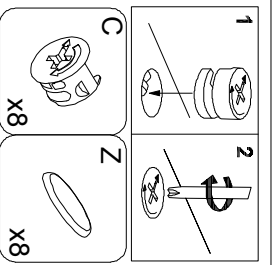

14

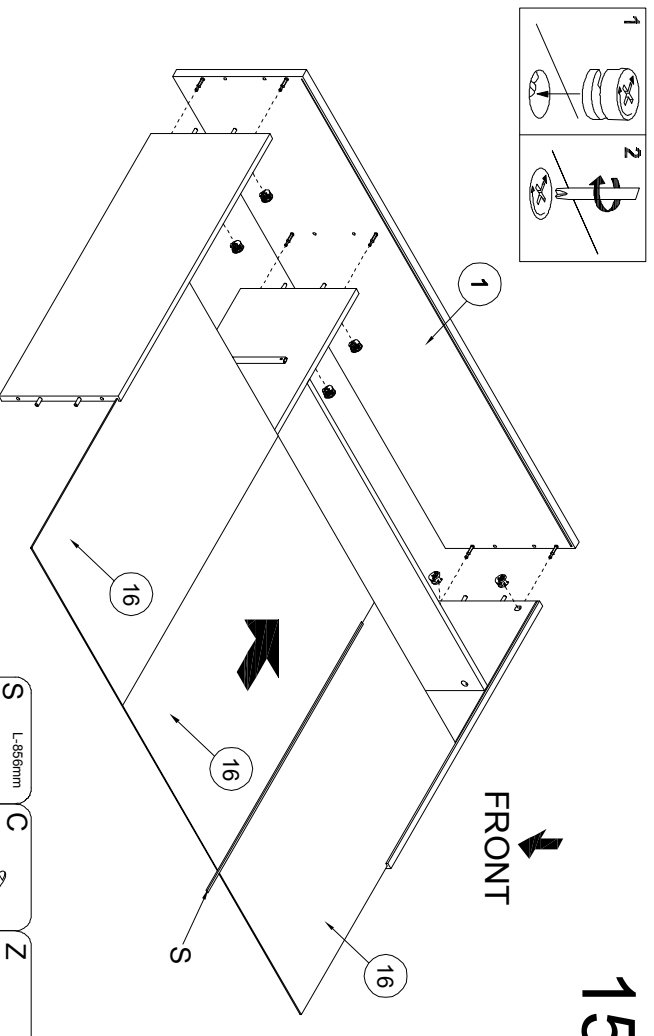
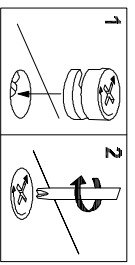

15

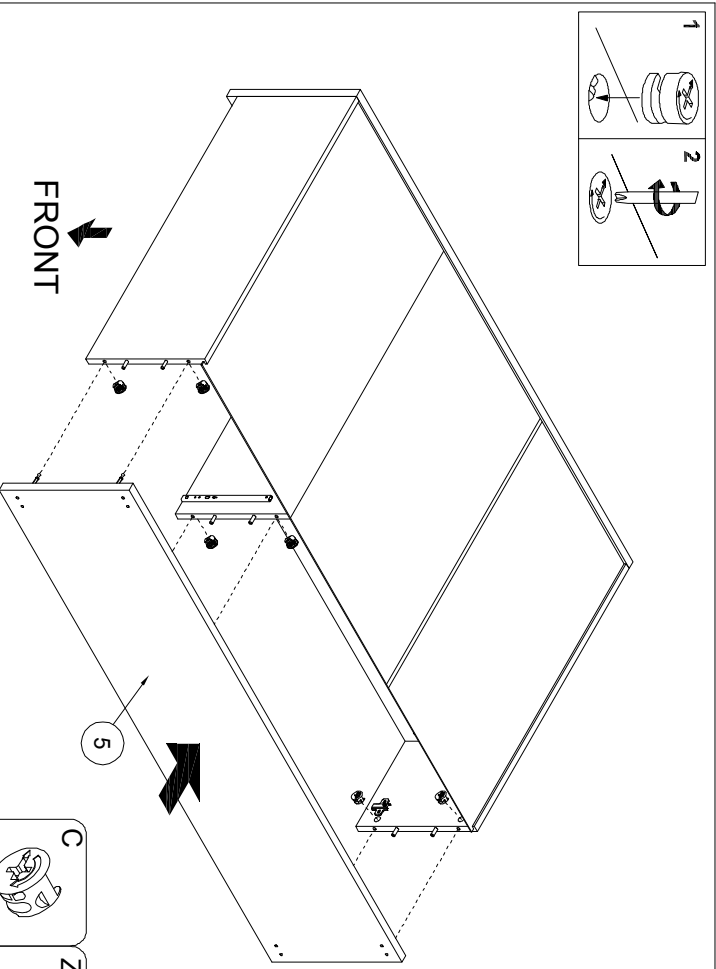
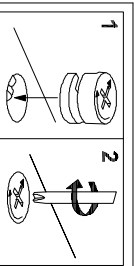
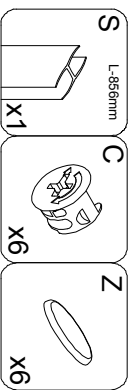

16

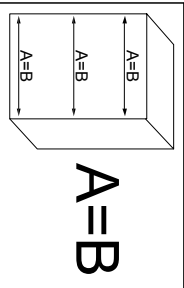

A=B

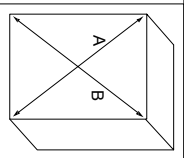

A=B

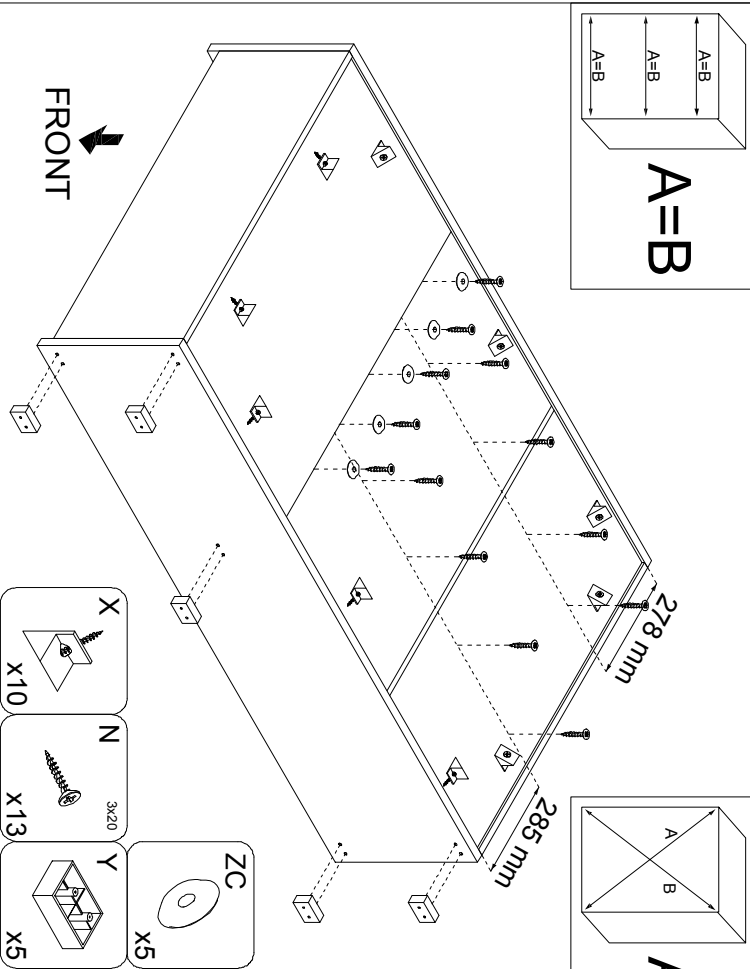
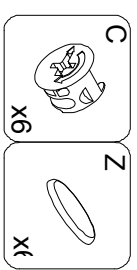

17



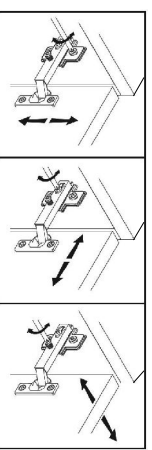

- NA 4x13 x6
- HA MAX20 x6

