

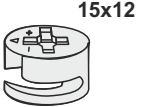

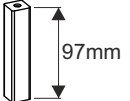









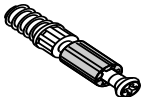

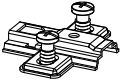



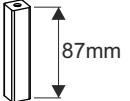
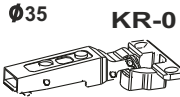



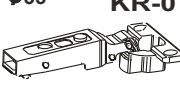

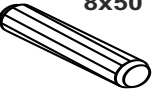





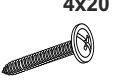

|   |  |   |   |  |
|---|--|---|---|--|
| <br>44x T02  | <br>4x N06    | <br>18x R01  | <br>19x G03  | <br>1x F11 |
| <br>28x T01  | <br>4x S10    | <br>10x Z21  | <br>17x W26  | <br>1x F01 |
| <br>8x T03   | <br>1x N07    | <br>4x Z22   | <br>3x C02   |  |
| <br>28x D01  | <br>1x S11    | <br>6x Z23   | <br>24x C01  |  |
| <br>8x D03   | <br>1x N08    | <br>20x W01  | <br>8x C03   |  |
| <br>12x E03 | <br>5x NS1   | <br>2x S42  | <br>10x G01 |  |
| <br>4x E01 | <br>1x K02  | <br>2x W27 | <br>1x P01 |  |
| <br>5x N05 | <br>20x W25 | <br>2x W28 | <br>2x W07 |  |

| NR | DIM         | QTE | COLLI |
|----|-------------|-----|-------|
| 1  | 1825x405x15 | 1   | 2/2   |
| 2  | 405x287x15  | 1   | 2/2   |
| 3  | 1251x405x15 | 1   | 2/2   |
| 4  | 405x287x15  | 1   | 2/2   |
| 5  | 870x404x18  | 1   | 1/2   |
| 6  | 870x404x18  | 1   | 1/2   |
| 7  | 1789x404x15 | 1   | 2/2   |
| 8  | 620x377x15  | 2   | 1/2   |
| 9  | 235x377x15  | 2   | 1/2   |
| 10 | 235x370x15  | 1   | 1/2   |
| 11 | 618x355x5   | 3   | 1/2   |
| 12 | 360x286x15  | 1   | 1/2   |
| 13 | 1251x215x15 | 1   | 2/2   |
| 14 | 630x286x15  | 1   | 1/2   |
| 15 | 1823x263x15 | 1   | 2/2   |
| 16 | 1351x464x4  | 1   | 2/2   |
| 17 | 1807x633x2  | 1   | 2/2   |
| 18 | 1807x248x2  | 1   | 2/2   |

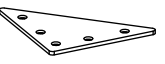

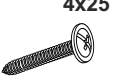
0 10 20 30 40 50 60 70 80 90 100 110 120 130 140 150 160 170 180 190 200

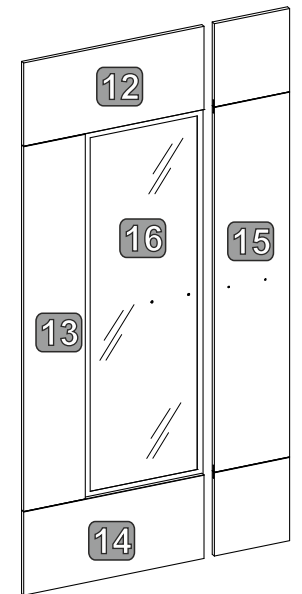
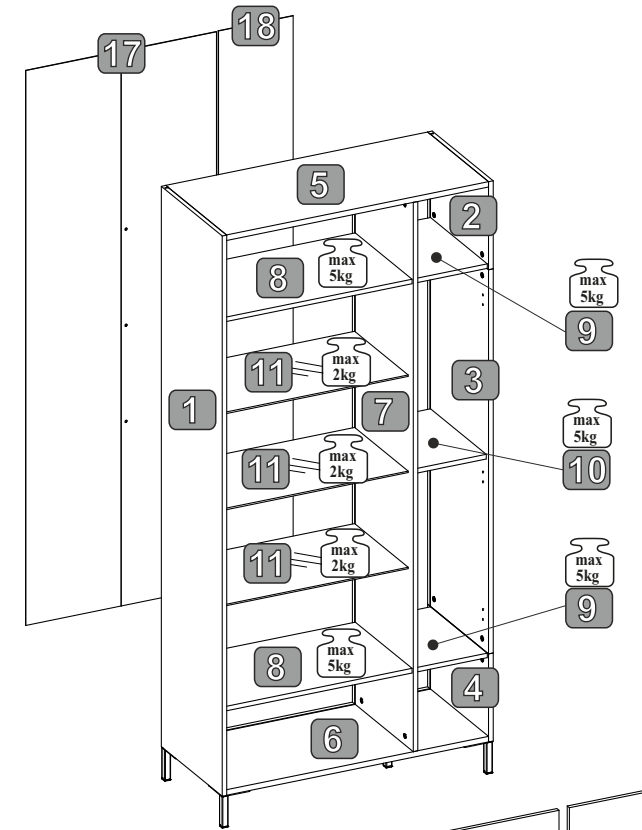

1

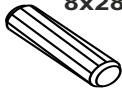
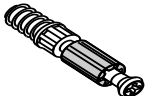
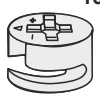
|   |   |  |
|---|---|--|
| 8x28<br> |  | 15x12<br> |
| 24x D01   | 4x T01  | 24x T02  |

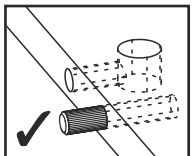
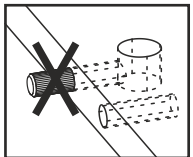
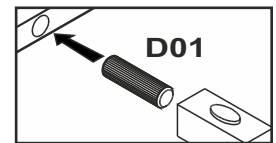
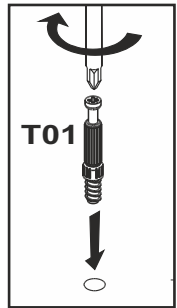
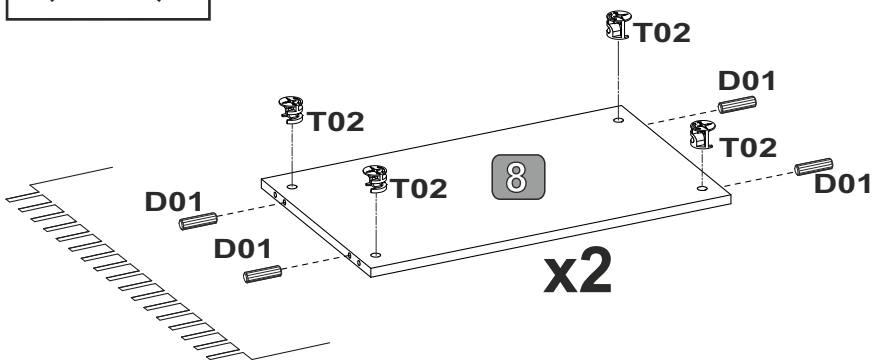
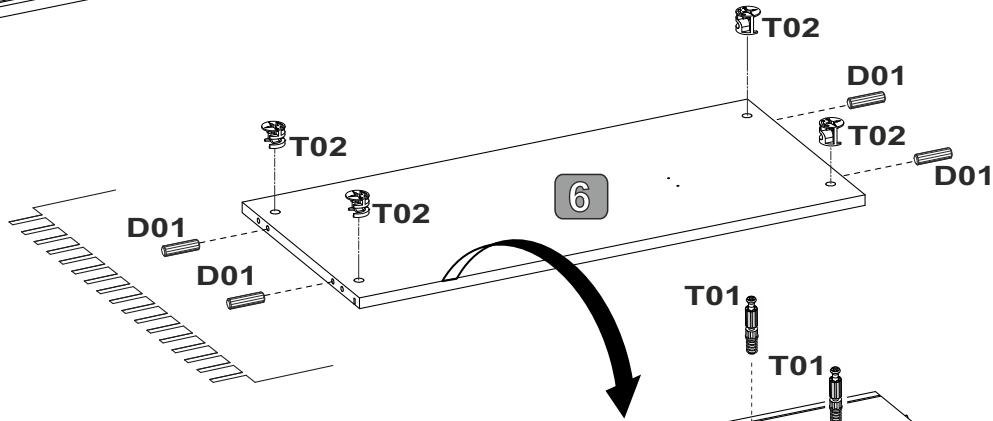
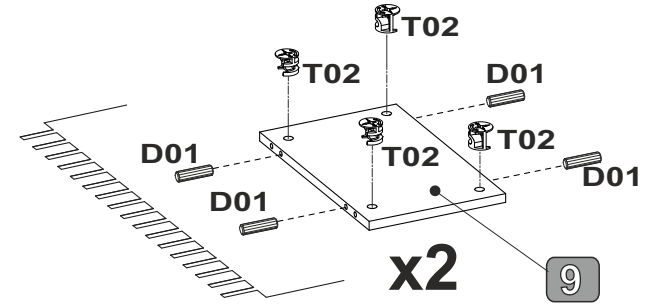
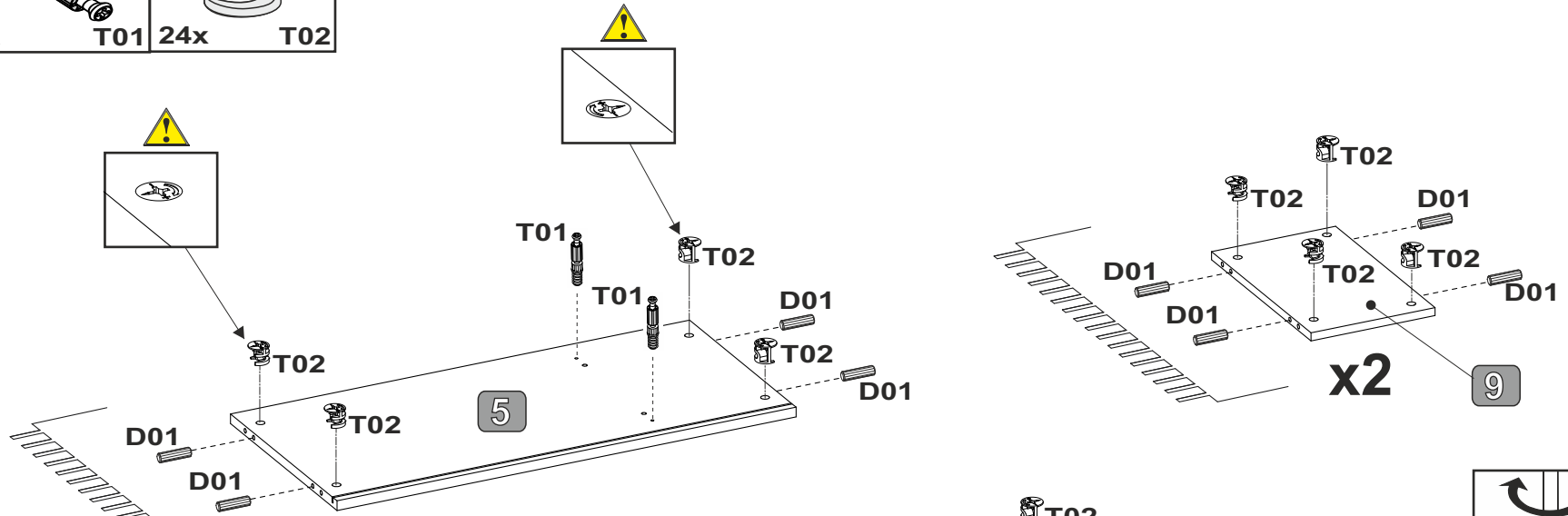
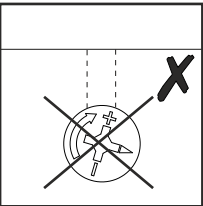
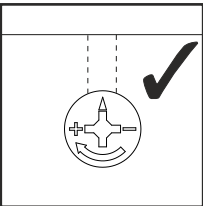
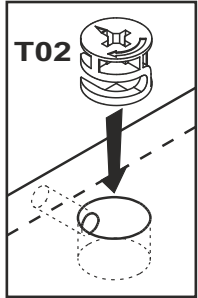

2

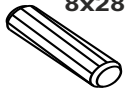
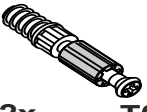
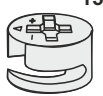
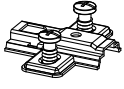
|   |   |  |   |  |
|---|---|--|---|--|
| <br>8x50 | <br>8x28 | <br>T01 | <br>15x12<br>T02 | <br>Z21 |
| 4x D03  | 4x D01  | 12x  | 8x  | 8x   |

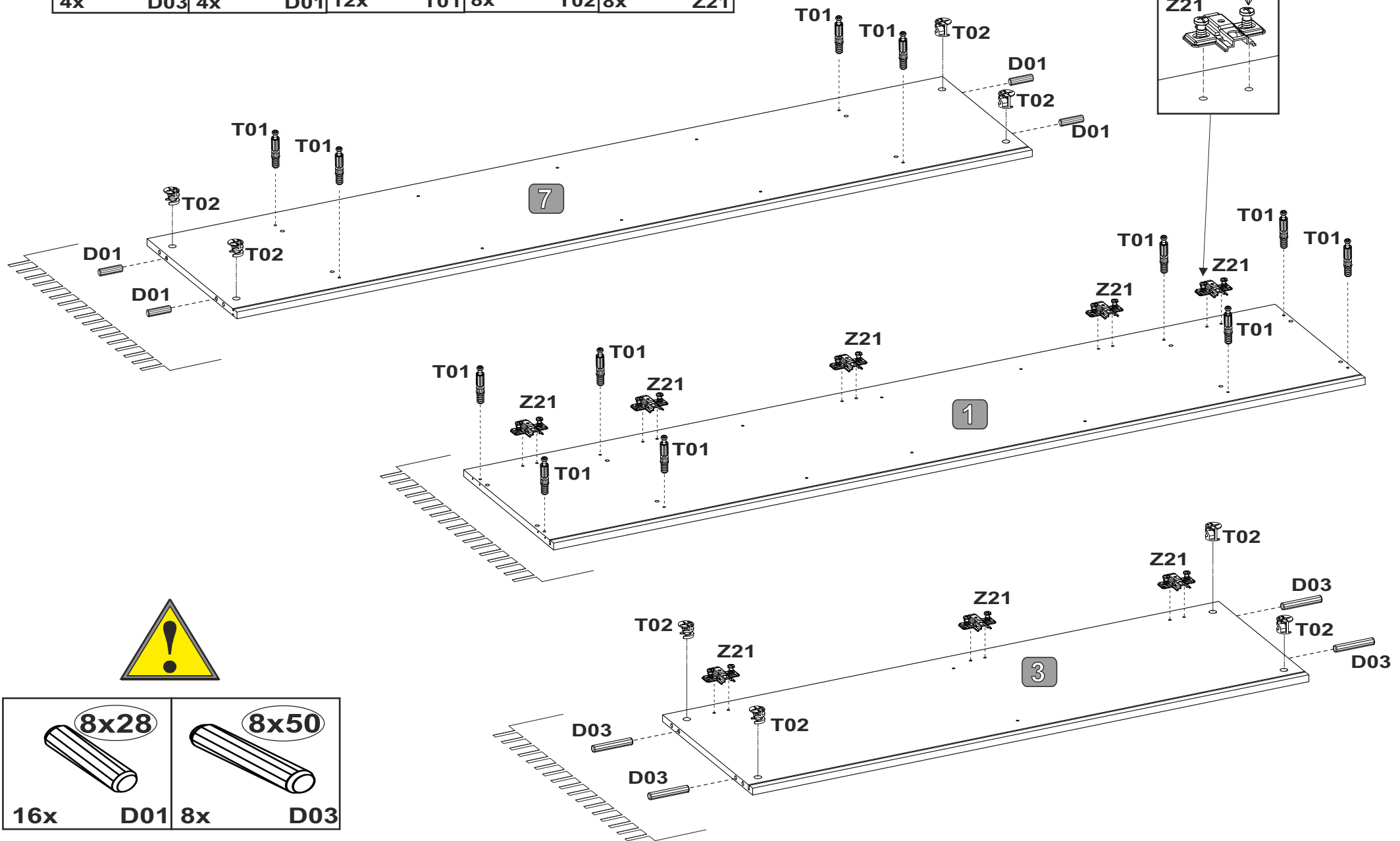

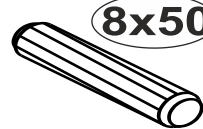
|   |   |
|---|---|
| <br>8x28 | <br>8x50 |
| 16x D01   | 8x D03  |

3

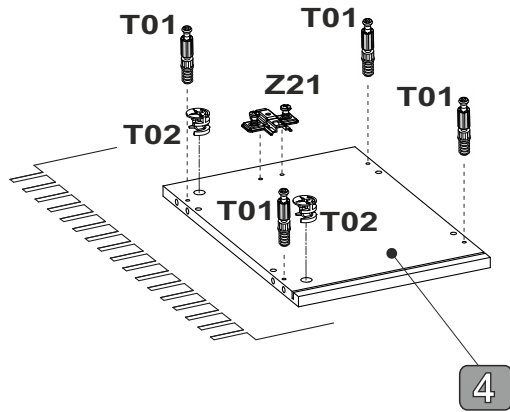
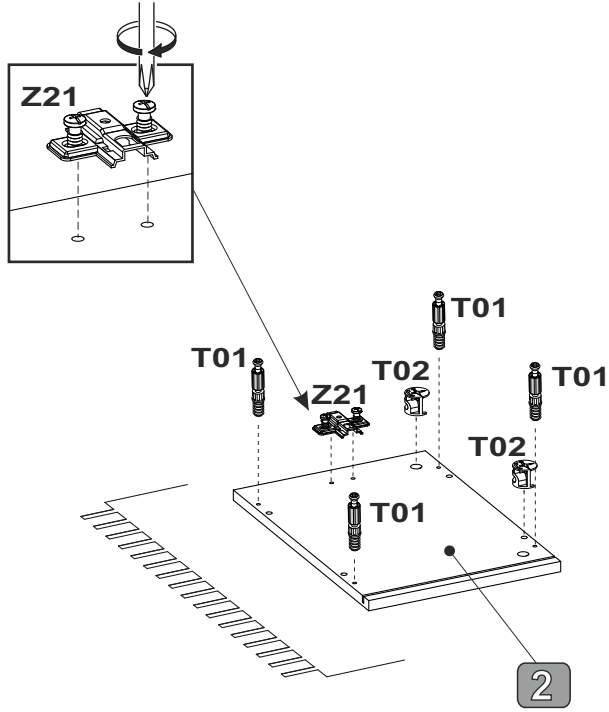
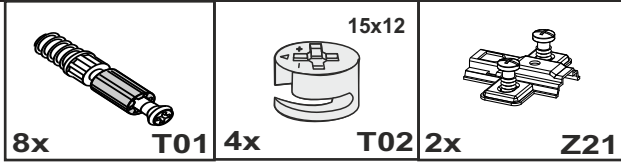

4

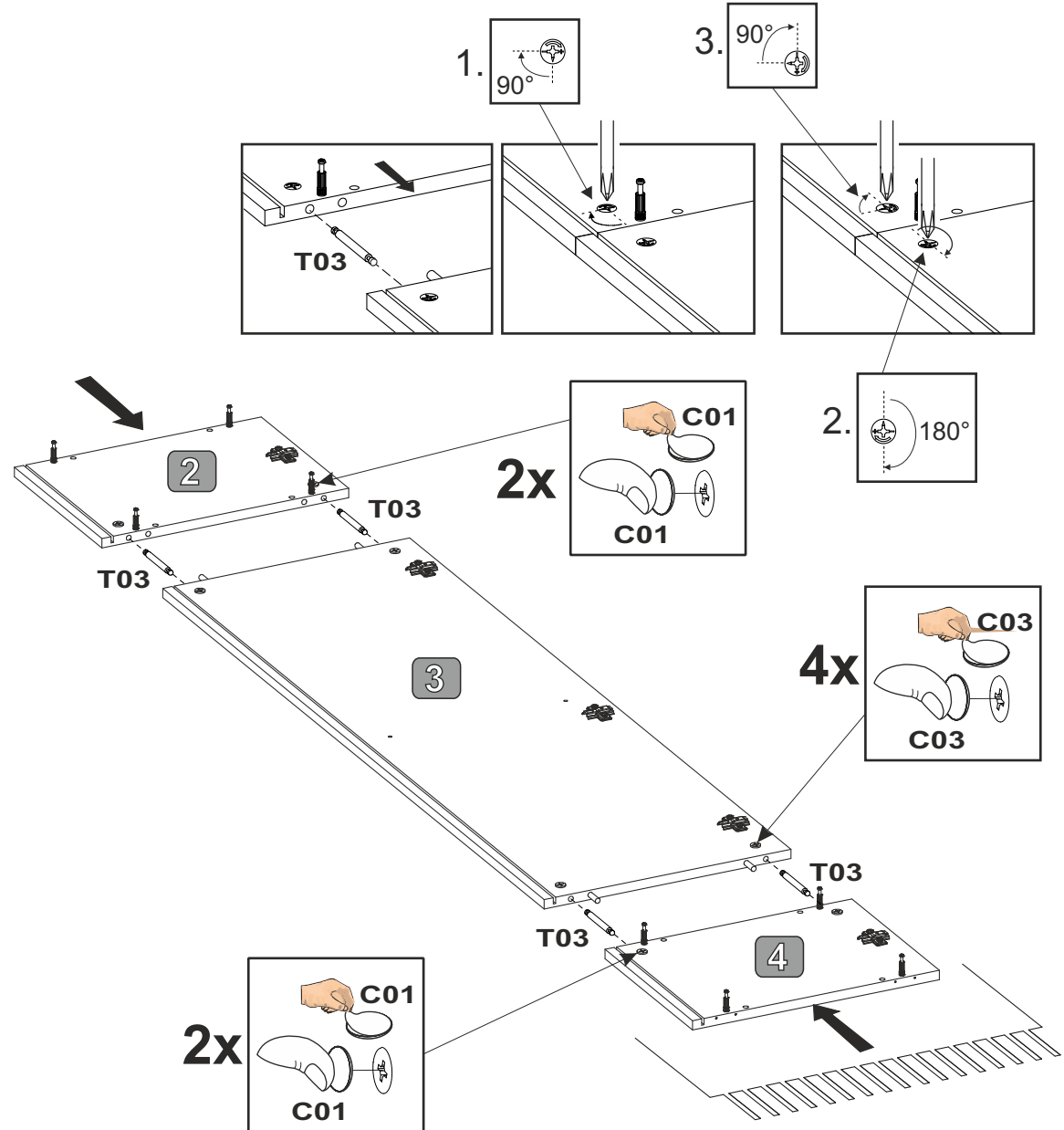
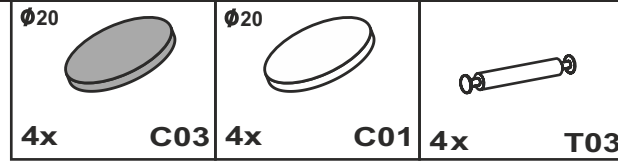

5

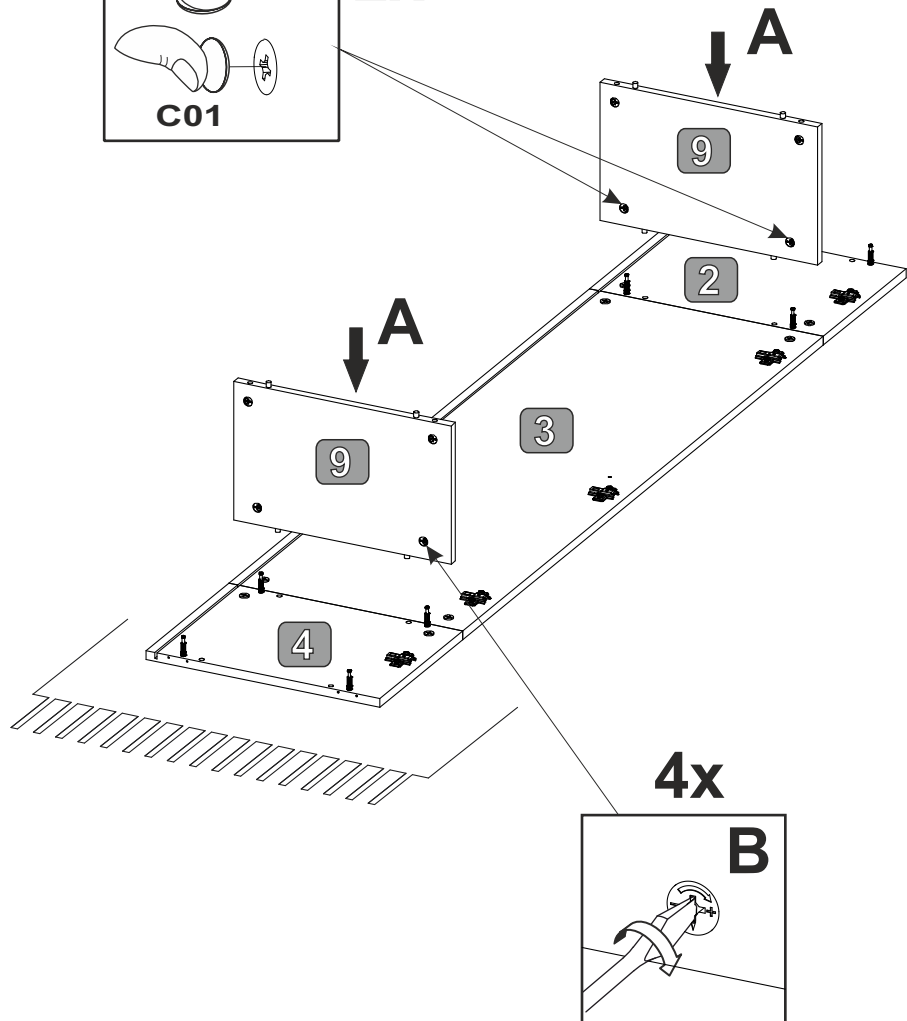
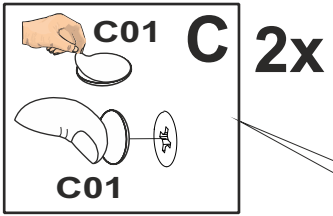
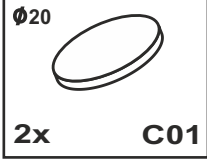

6

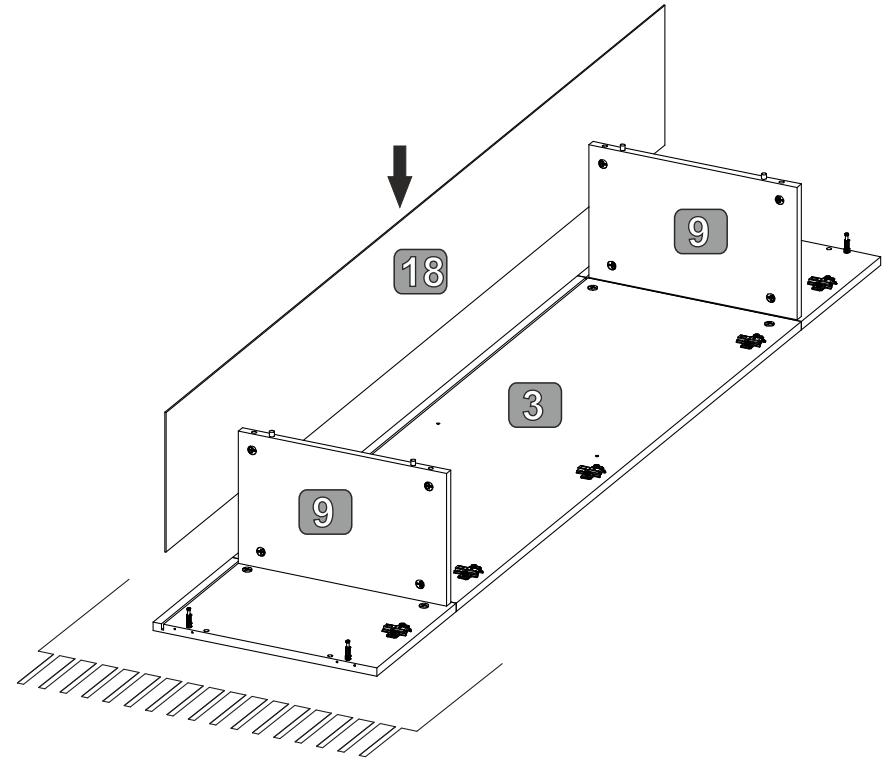

7

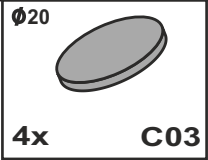

4x

4x

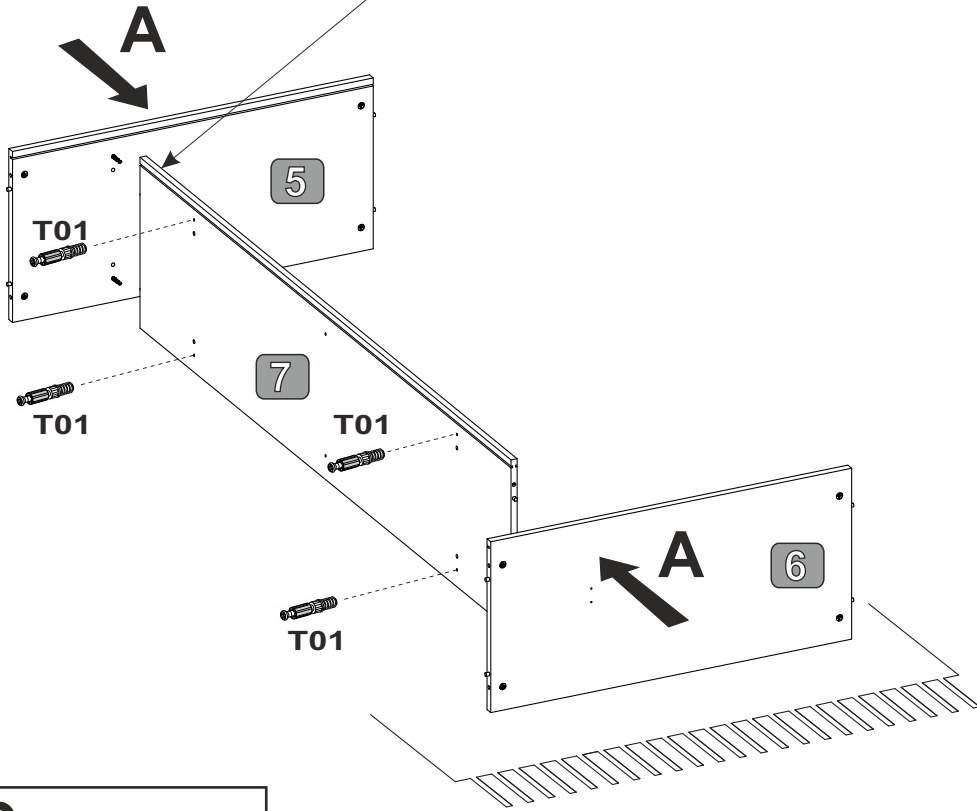
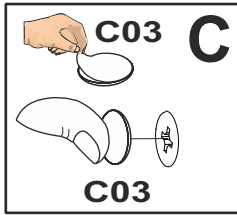
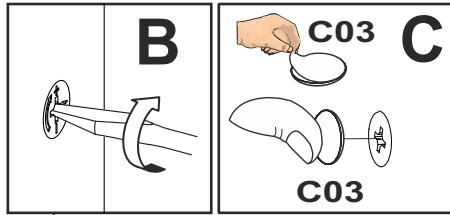

8

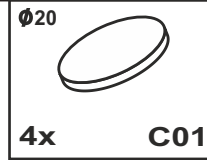

8x

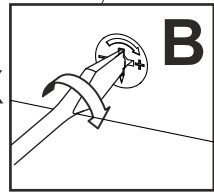

4x

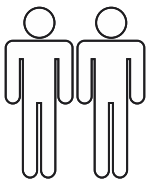
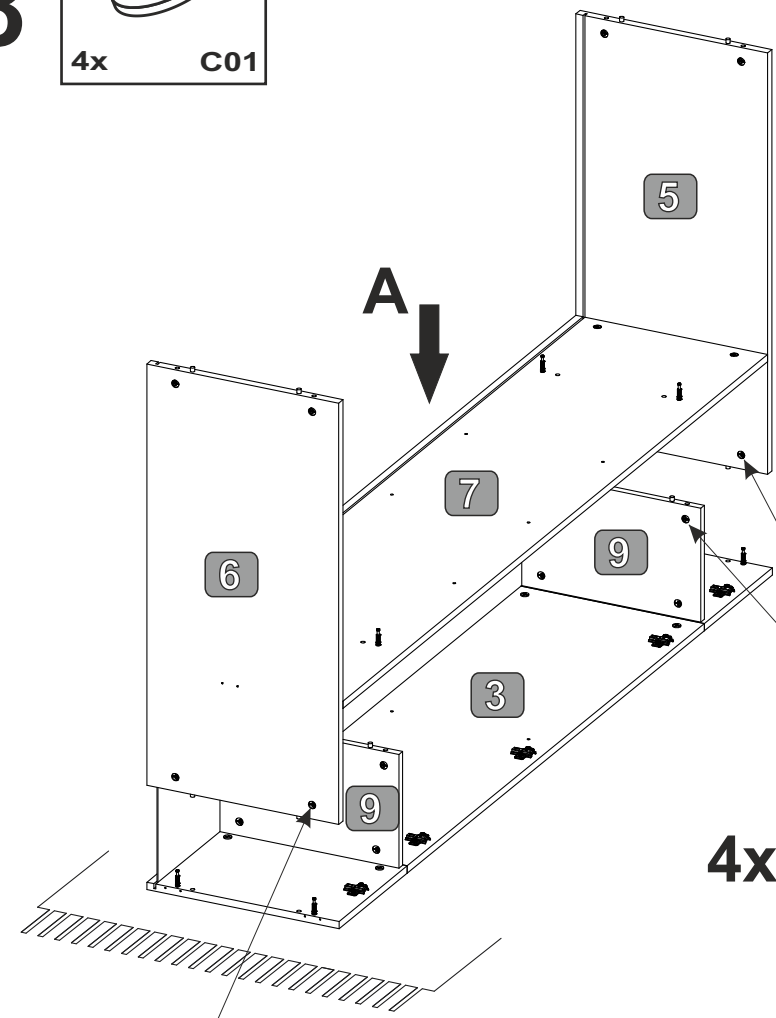
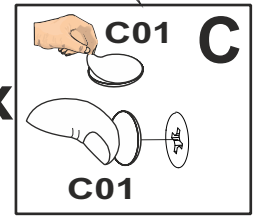

9

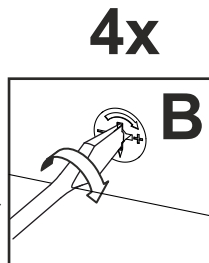
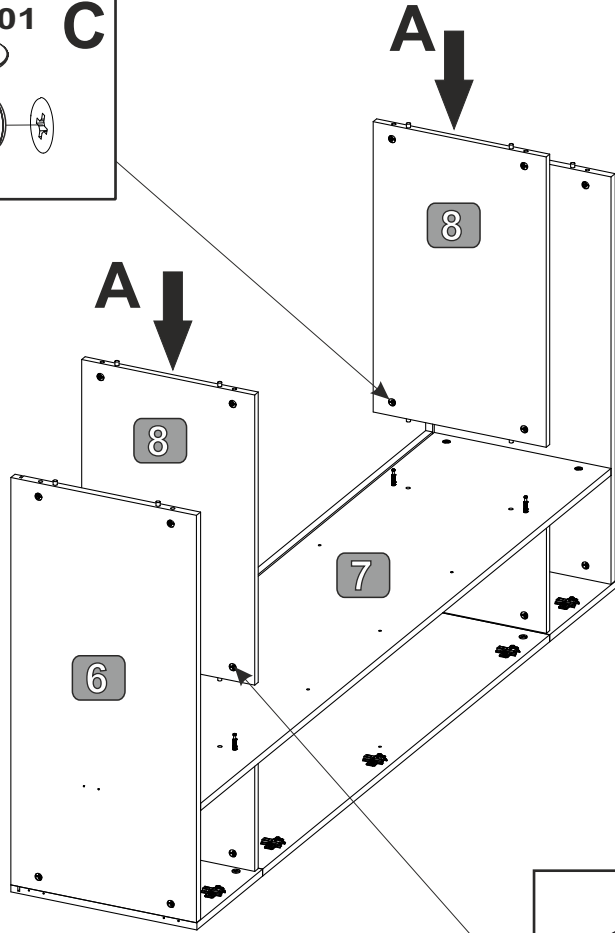
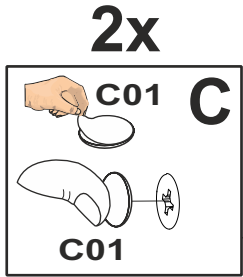
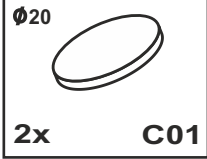

10

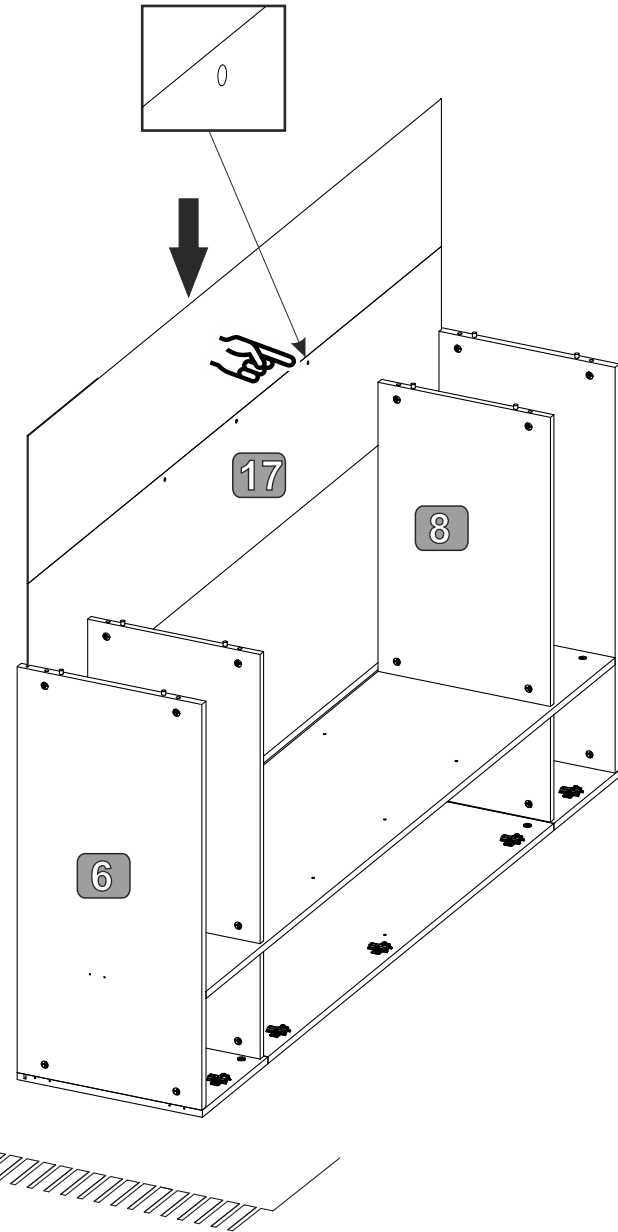





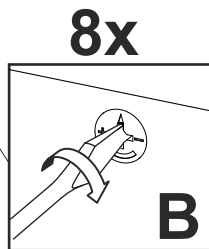
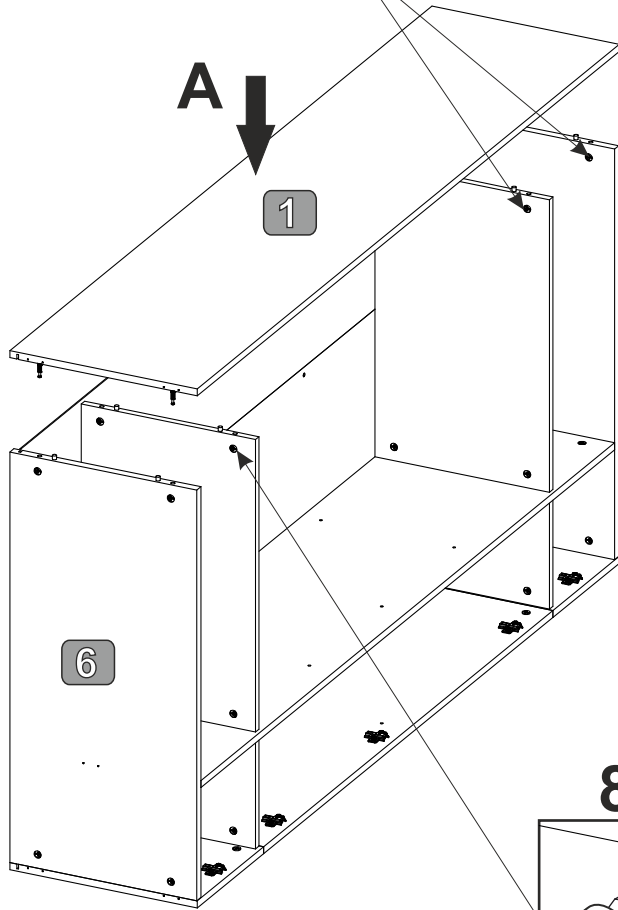
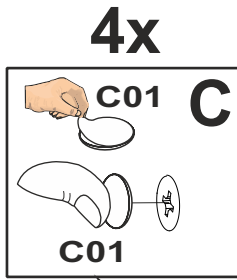
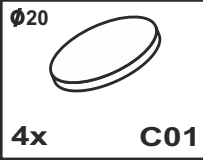

11

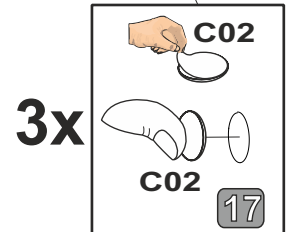
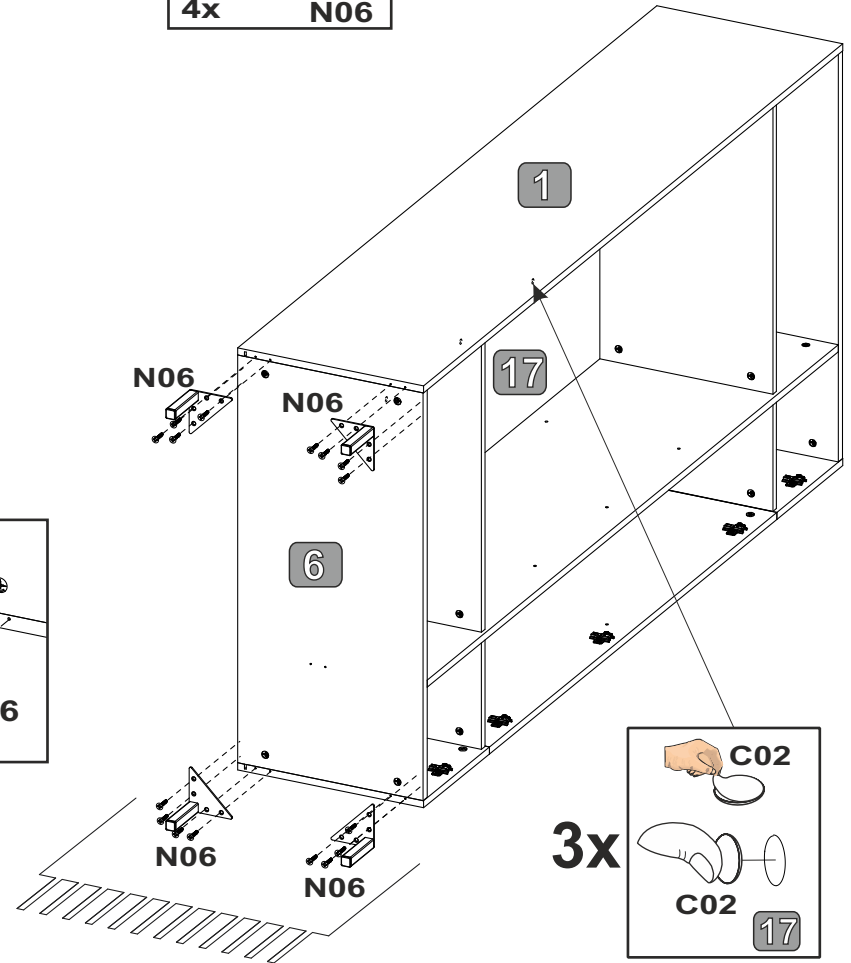
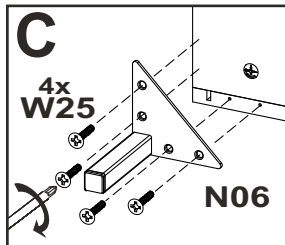
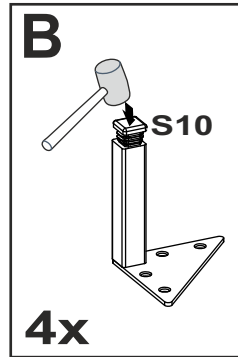
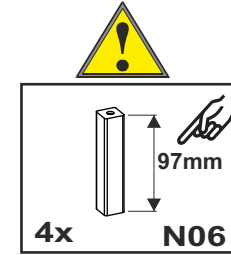
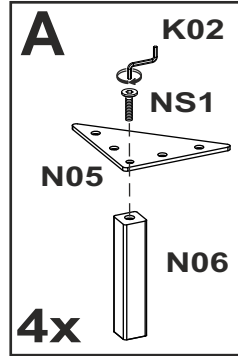
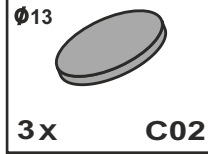
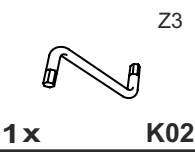
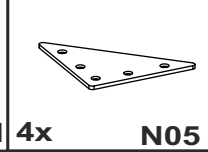
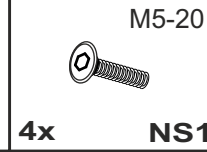
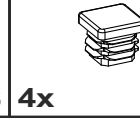
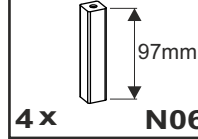

12

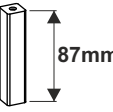

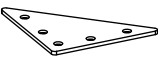
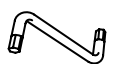
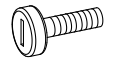

# 13

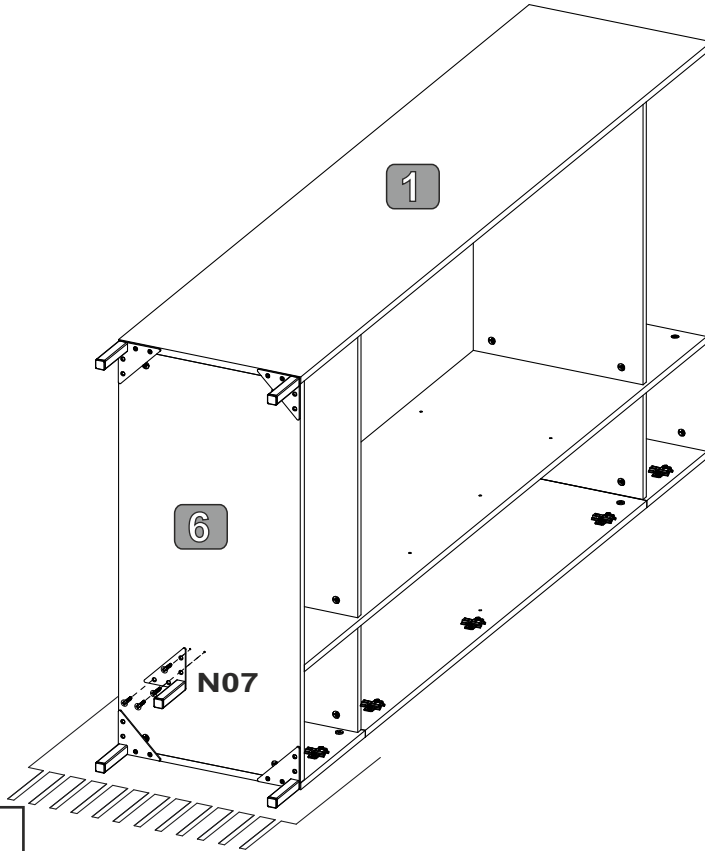
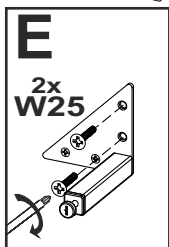
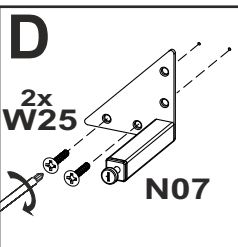
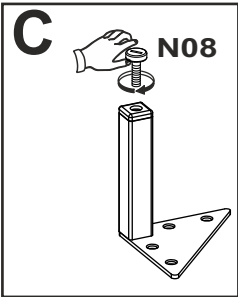
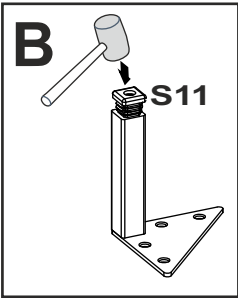
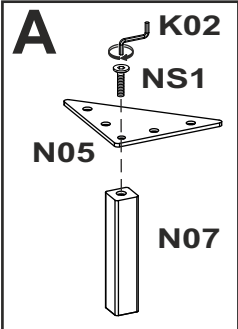
|  |  |  |   |  |      |
|--|--|--|---|--|------|
| 1x<br>N07<br> | 1x<br>S11<br> | 1x<br>NS1<br> | 1x<br>N05<br> | 1x<br>K02<br> | Z3   |
|  |  |  | 1x<br>N08<br>  | 4x<br>W25<br> | 4x16 |



# 14

|   |   |
|---|---|
| 18x<br>R01<br> | 10x<br>G01<br> |
|---|---|

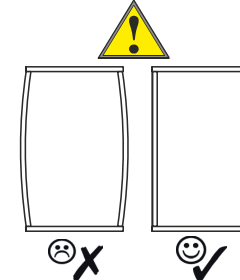

## a=b

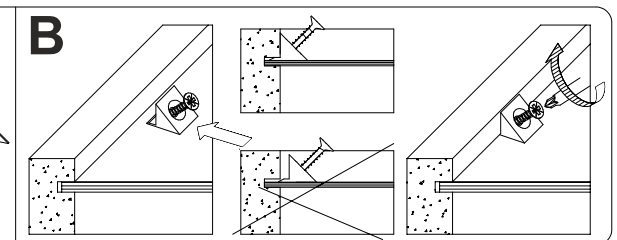
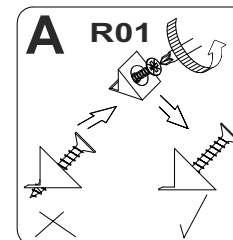
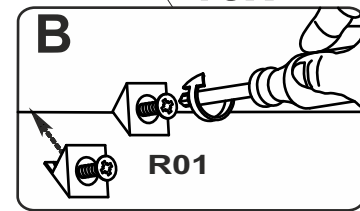
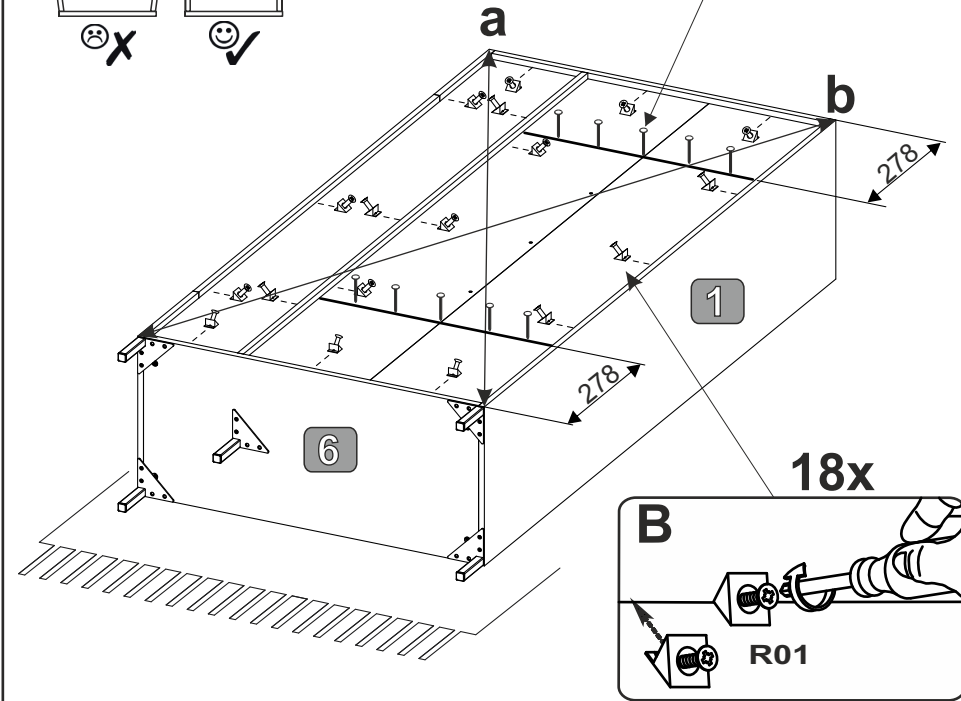
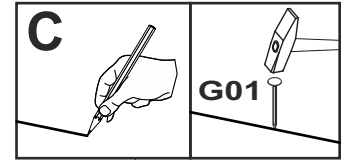

15

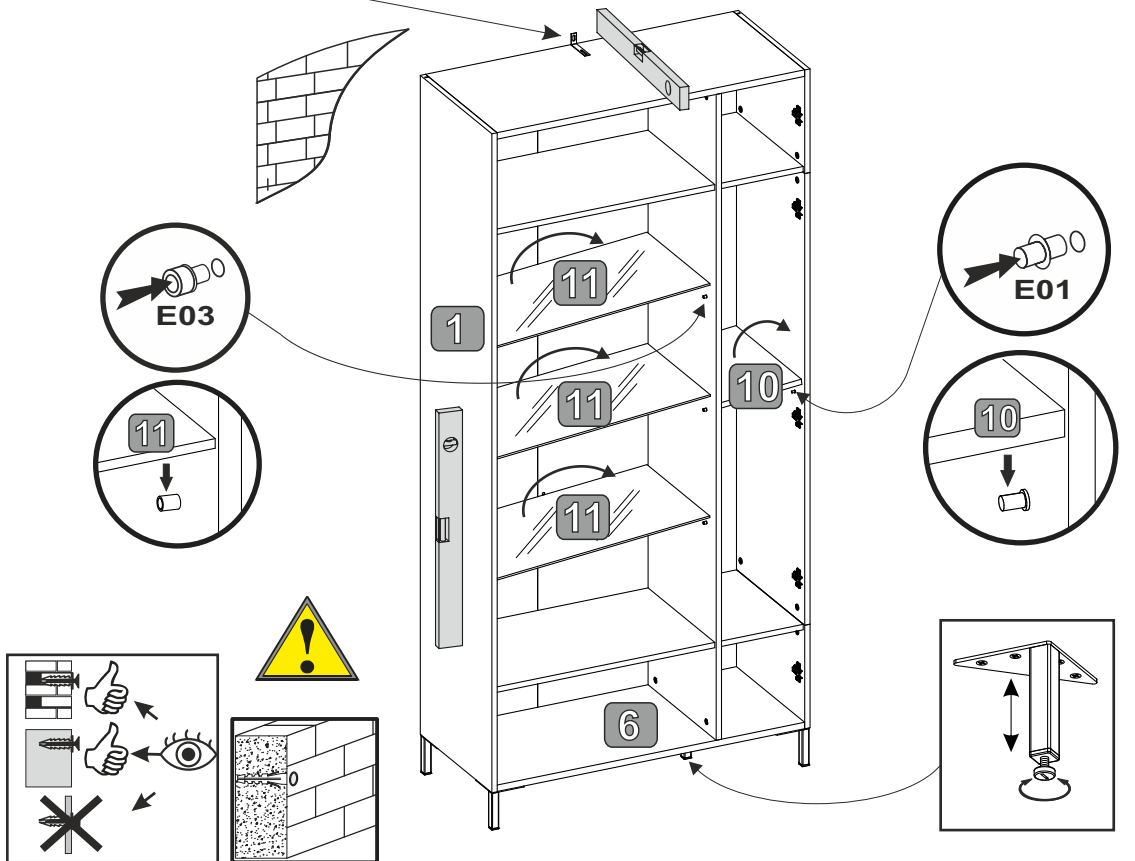
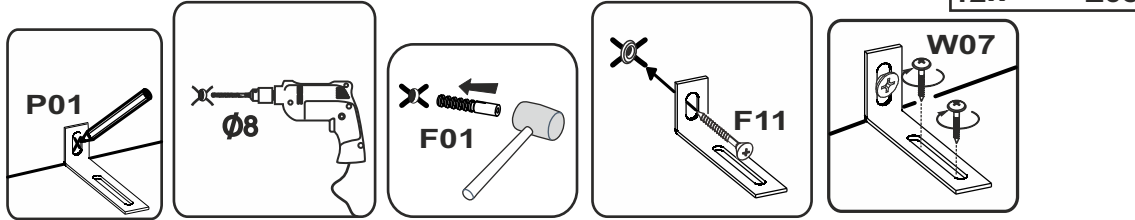
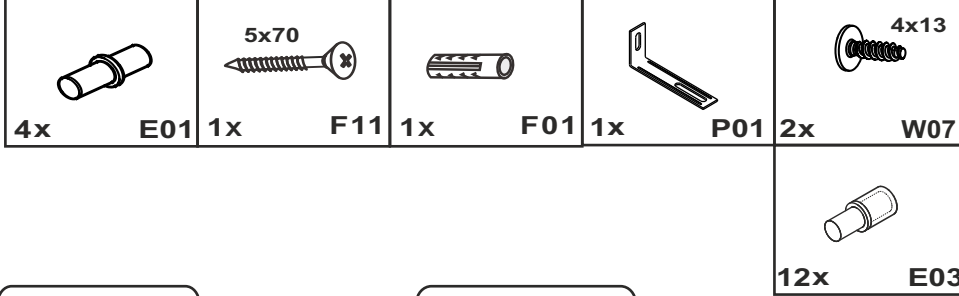

16

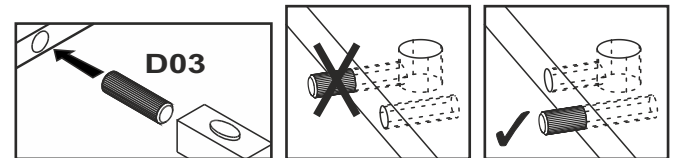
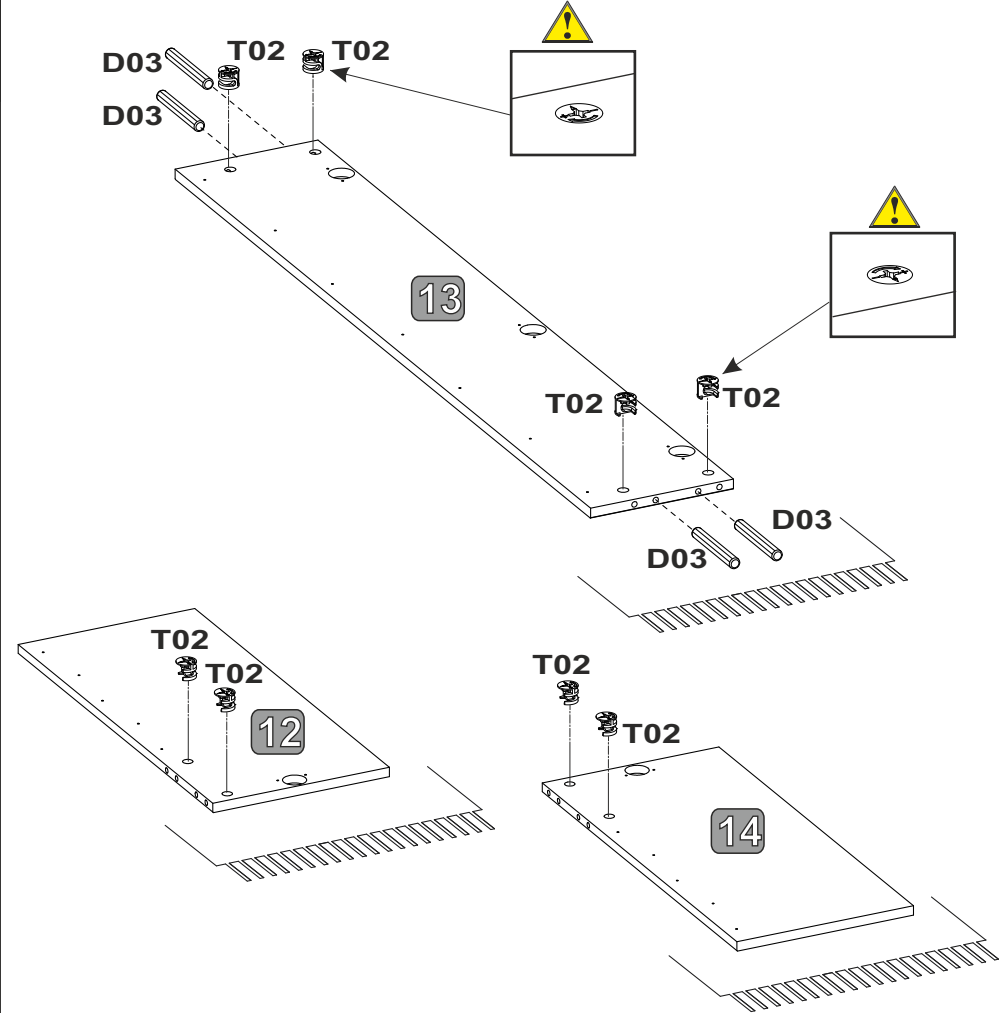
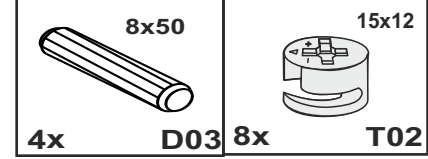

17

Ø20



8x

C01

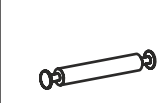

4x

T03

1.

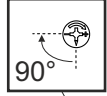

3.

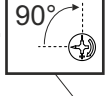

2.

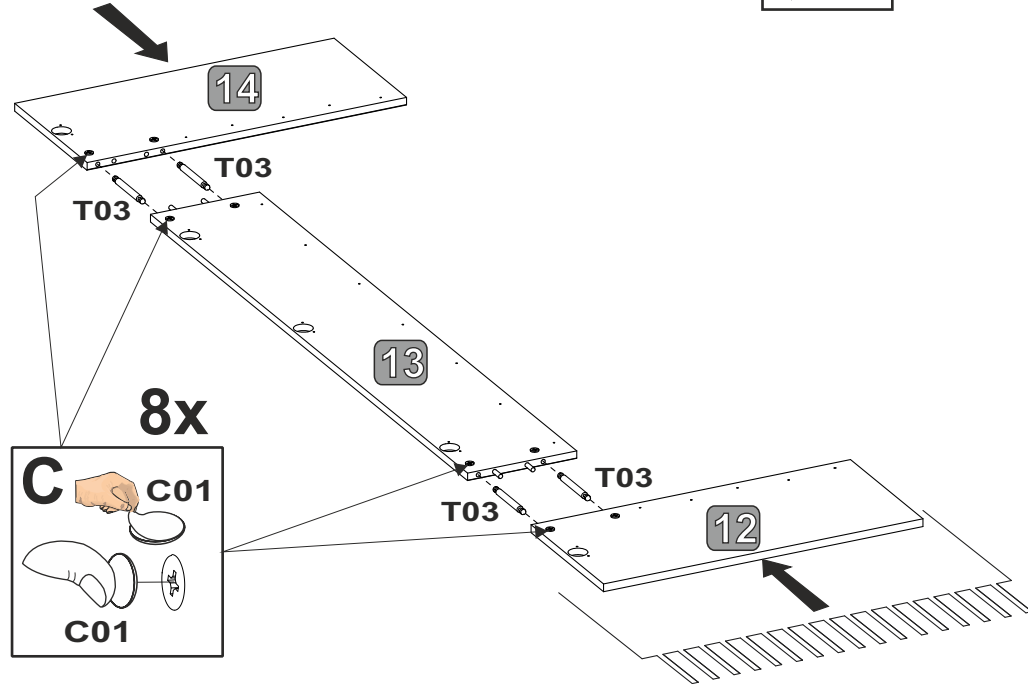
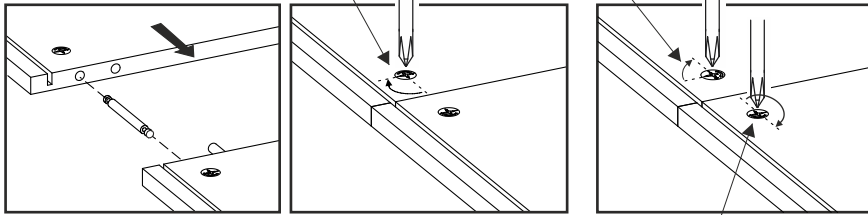

18

Ø35

KR-0

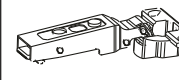

4x

Z22

Ø35

KR-0

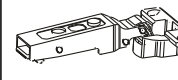

6x

Z23

3,5x16

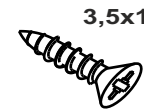

20x

W01



17x

G03

3,5x16





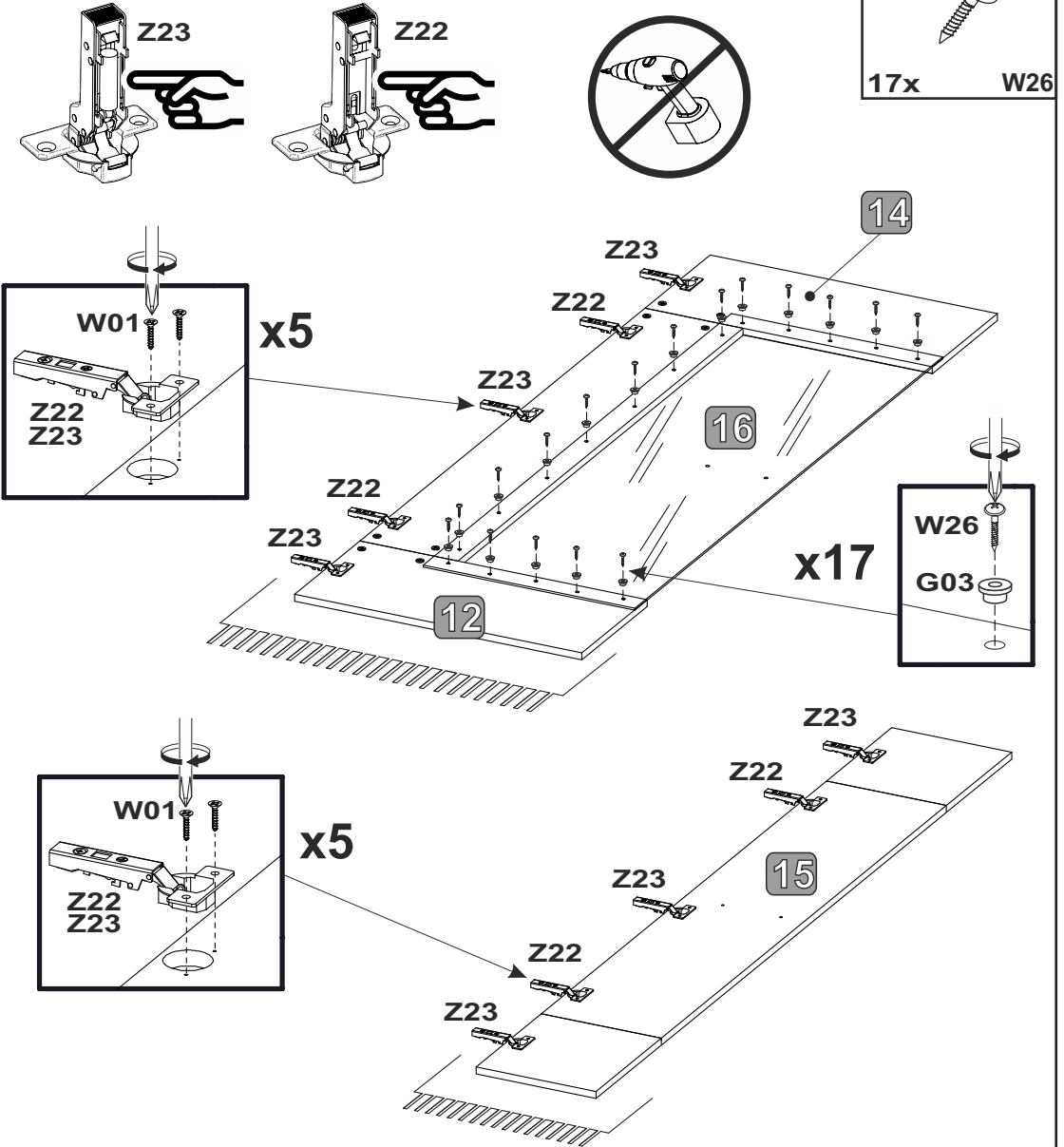

17x



W26



# 19

|   |   |   |   |
|---|---|---|---|
|  |  |  |  |
| 2x  | 2x  | 2x  | 2x  |
| G03   | S42   | W27   | W28   |



|   |      |
|---|------|
|  | 4x25 |
| 2x  | W28  |
|  | 4x20 |
| 2x  | W27  |

