

# INSTRUKCJA MONTAŻU

FITTING-UP INSTRUCTION / AUFBAUANLEITUNG  
MONTÁŽNÍ NÁVOD / MONTÁŽNY NÁVOD

Producent:  
**Restol sp. z o.o.**  
36-055 BRATKOWICE  
www.restol.com.pl

# Thea AHW-2L

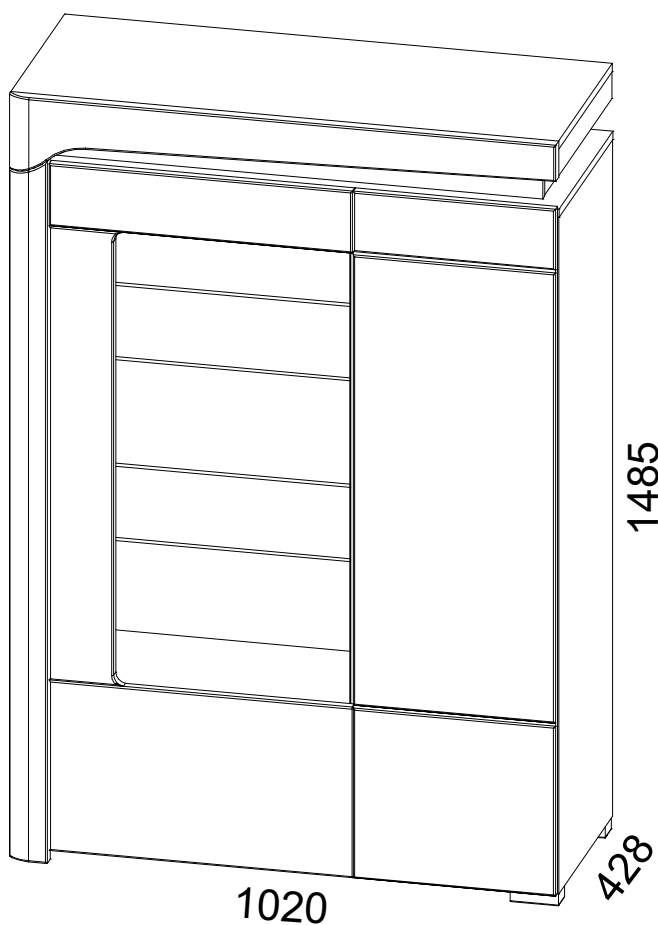

1020 x 1485 x 428 /mm/

## **POKYN pro ošetřování nábytku!**

Díly čistit vlhkým hadříkem nebo papírovou utěrkou.

Nepoužívat chemické čisticí prostředky.

## **POKYNY k údržbě nábytku.**

Prvky nábytku čistit vlhkou handričkou alebo papírovou utěrkou.

Nepoužívat chemické čistiace prostriedky.

## **WSKAZÓWKA na temat pielęgnacji mebla.**

Czyścić elementy wilgotną szmatką lub papierowym ręcznikiem.

Nie używać chemicznych środków czyszczących.

## **DIRECTION for the furniture cleaning.**

Clean elements with the moist wiper or soft paper towel. Do not use any detergents.

## **Pflegehinweiss.**

Nur mit feuchtem Lappen, bzw. Papiertuch Ihre Möbel reinigen. Keine chemischen Waschmittel einsetzen.

INSTRUKCJA MONTAŻU  
FITTING-UP INSTRUCTION / AUFBAUANLEITUNG  
MONTÁŽNÍ NÁVOD / MONTÁŽNY NÁVOD

# Thea AHW-2L

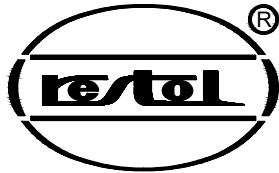

Do montażu potrzebne są:

You need for fitting-up:

Zur Montage werden Sie brauchen:

K montáži jsou potřebné:

Na montáž potrebujete:

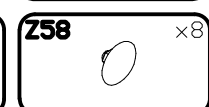
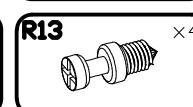
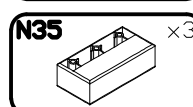
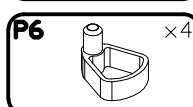
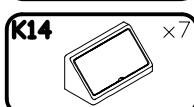
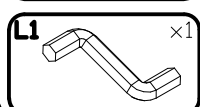
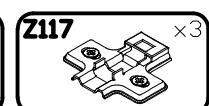
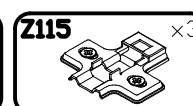
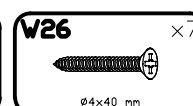
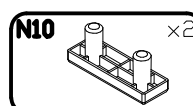
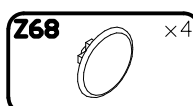
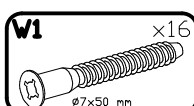
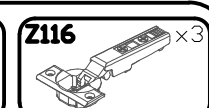
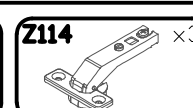
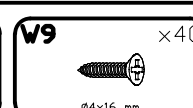
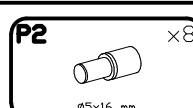
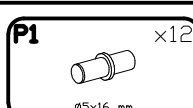
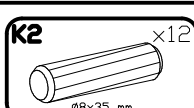
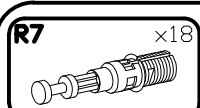
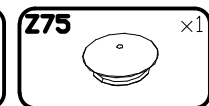
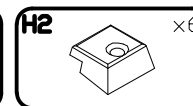
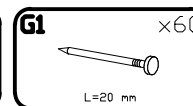
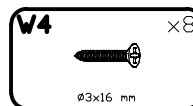
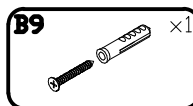
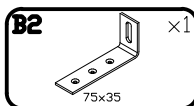
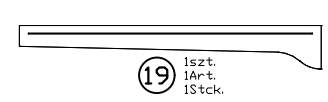
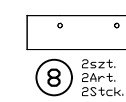
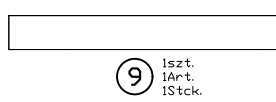
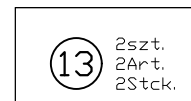
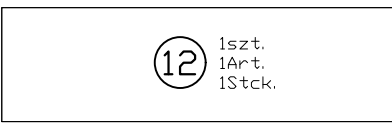
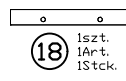
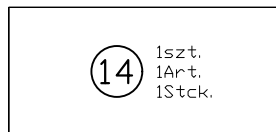
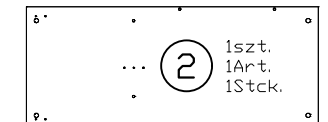
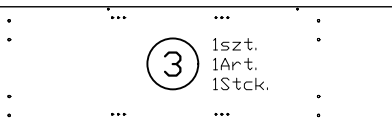
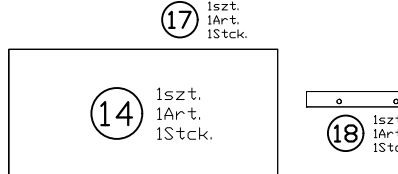
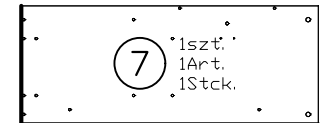
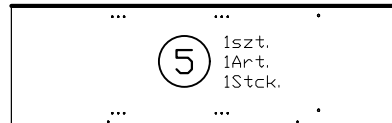
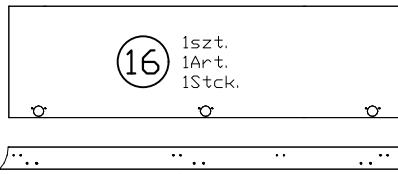
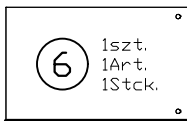
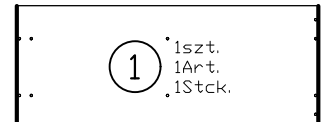
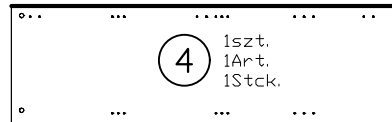
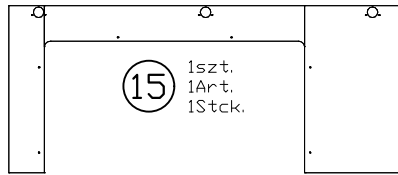
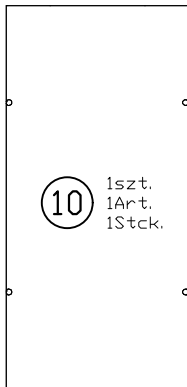
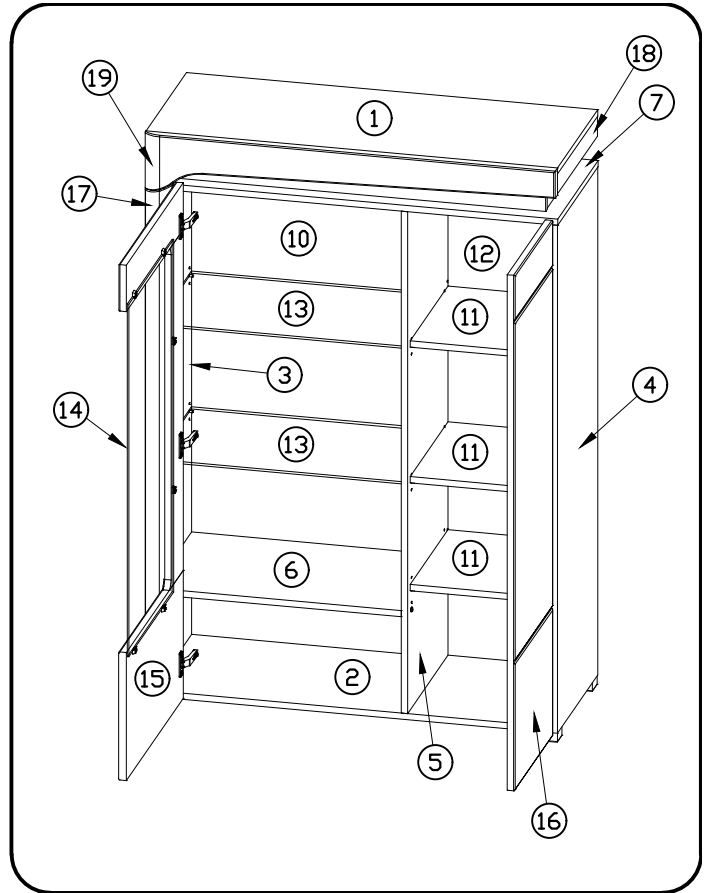
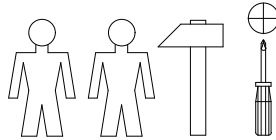

PODCZAS MONTAŻU POSTĘPOWAĆ ZGODNIE Z INSTRUKCJĄ  
 WHILE ASSEMBLING FOLLOW THE INSTRUCTION / MONTAGE LAUT DER AUFBAUANLEITUNG DURCHFÜHREN  
 PŘI MONTÁŽI POSTUPOVAT PODLE NÁVODU / PRI MONTÁŽI POSTUPOJTE PODĽA NÁVODU

# 1<sup>TH</sup> AHW-2L

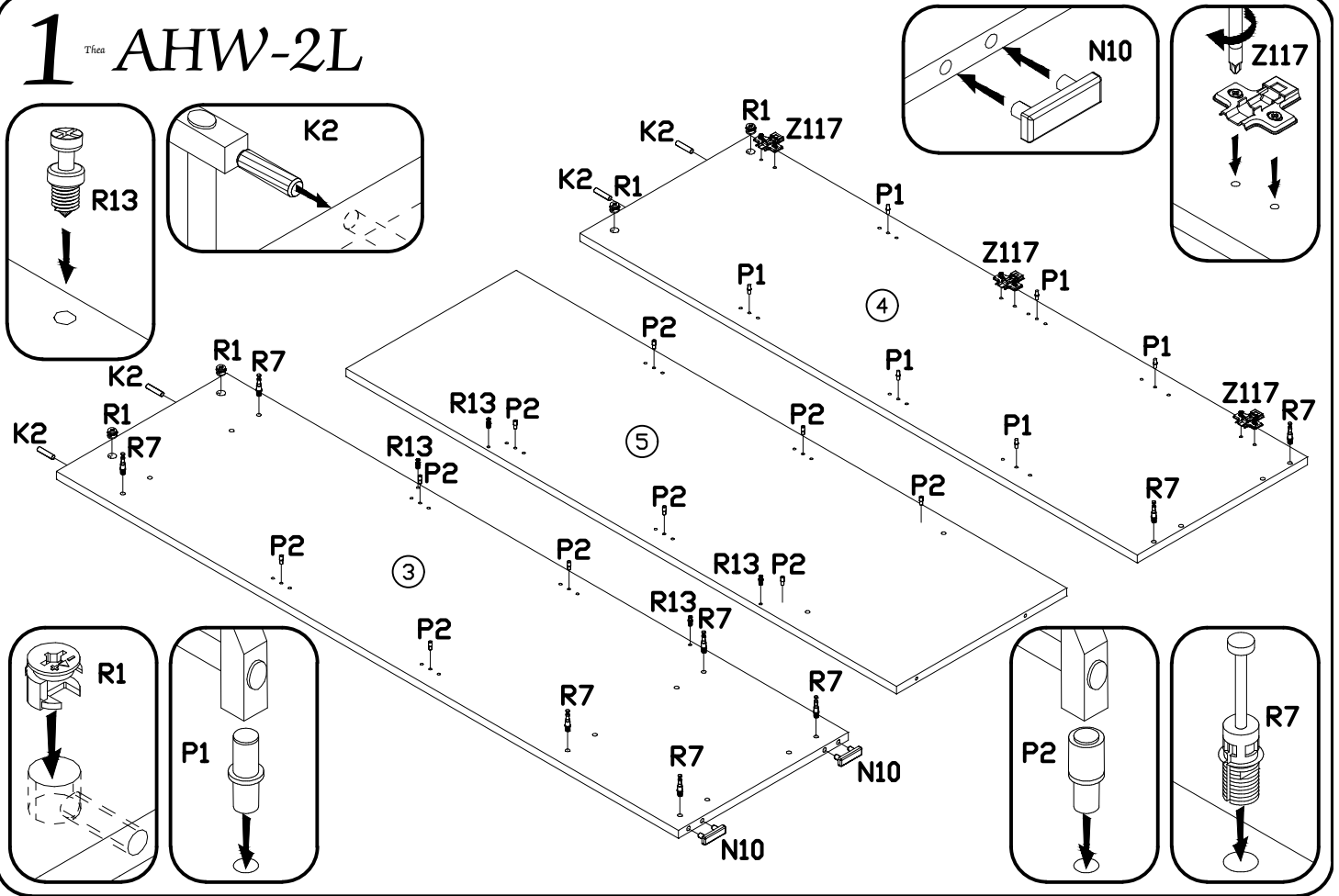

# 2<sup>TH</sup> AHW-2L

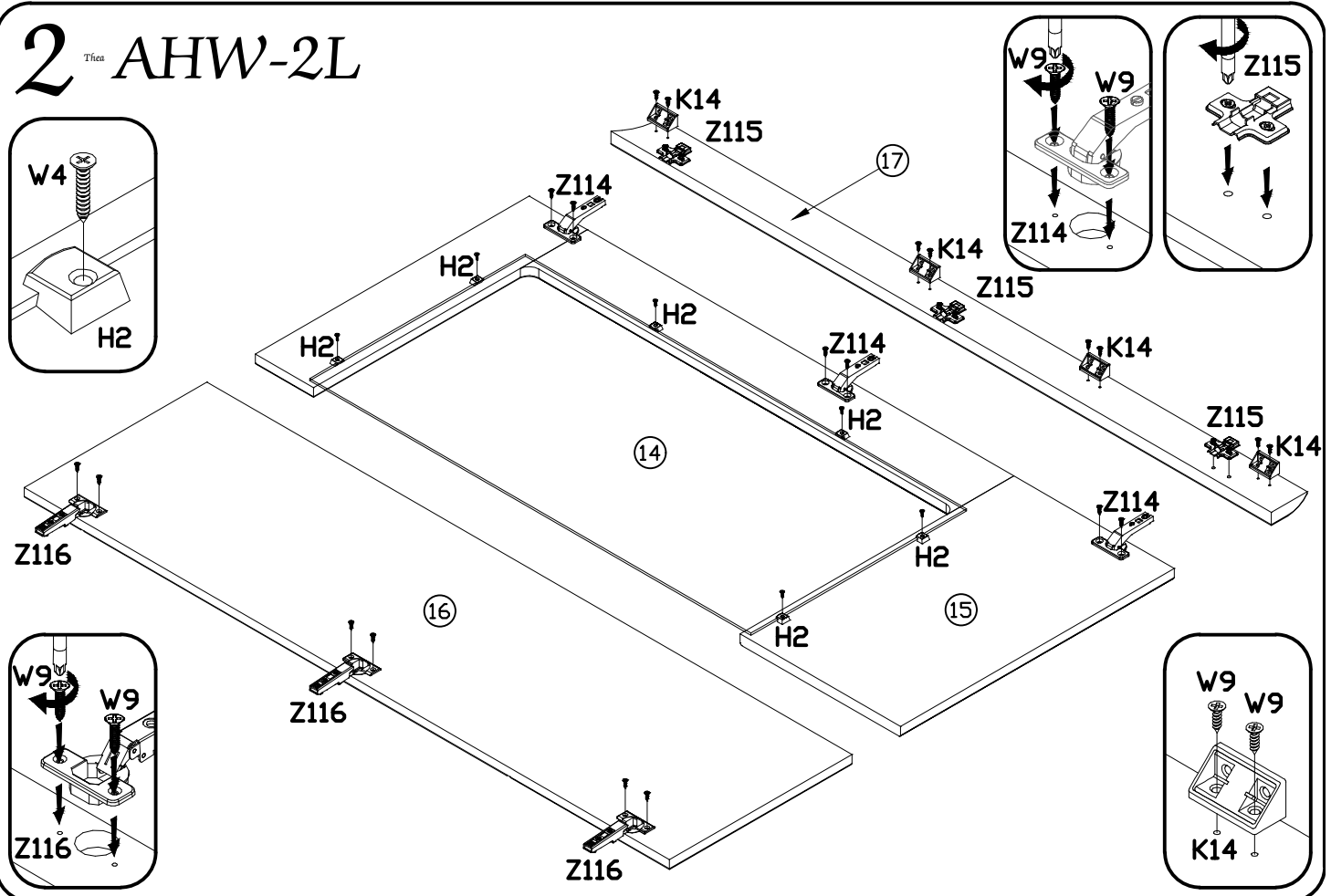

PODZAS MONTAŻU POSTĘPOWAĆ ZGODNIE Z INSTRUKCJĄ  
WHILE ASSEMBLING FOLLOW THE INSTRUCTION / MONTAGE LAUT DER AUFBAUANLEITUNG DURCHFÜHREN  
PŘI MONTÁŽI POSTUPOVAT PODLE NÁVODU / PRI MONTÁŽI POSTUPOJTE PODĽA NÁVODU

### 3<sup>TH</sup> AHW-2L

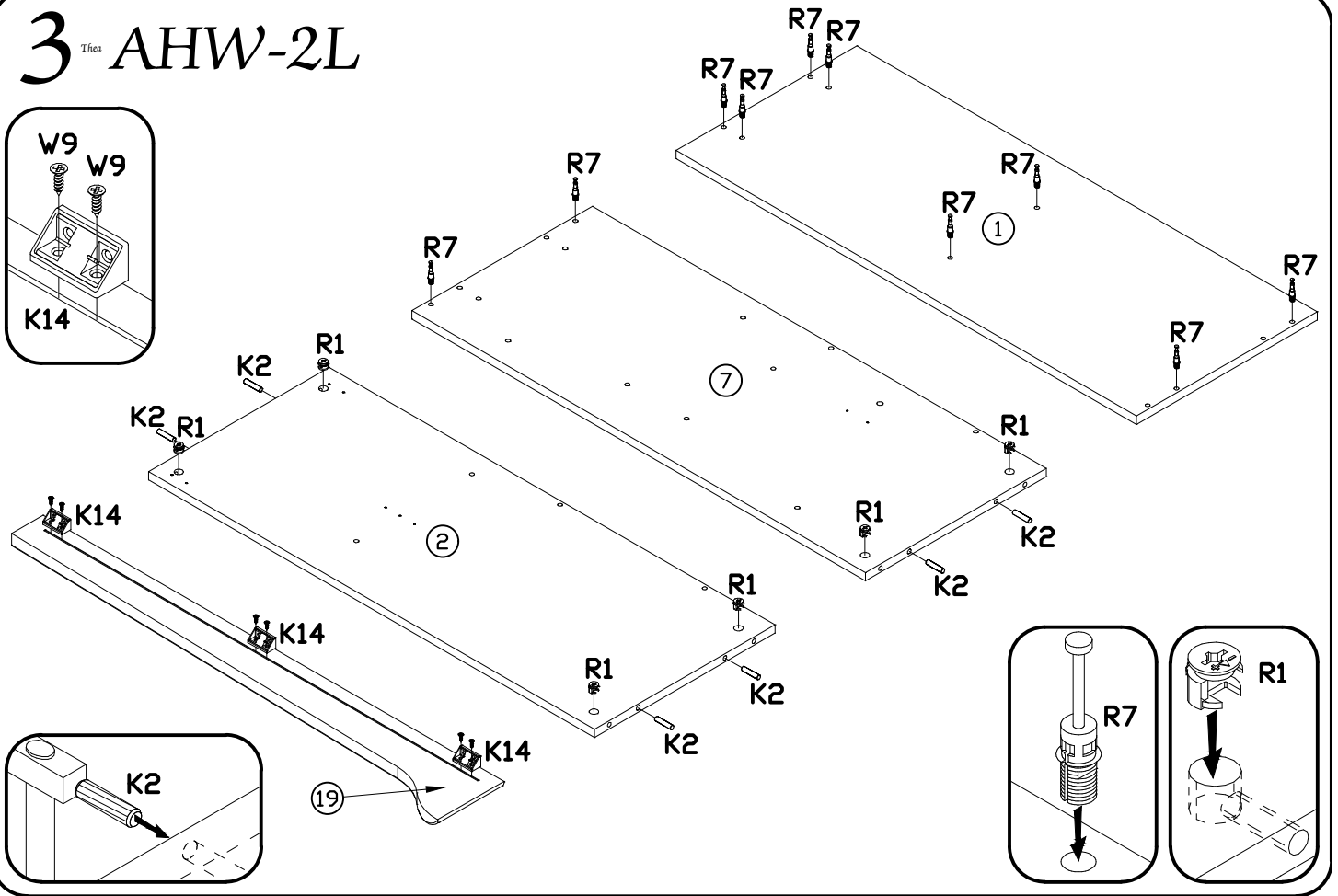

### 4<sup>TH</sup> AHW-2L

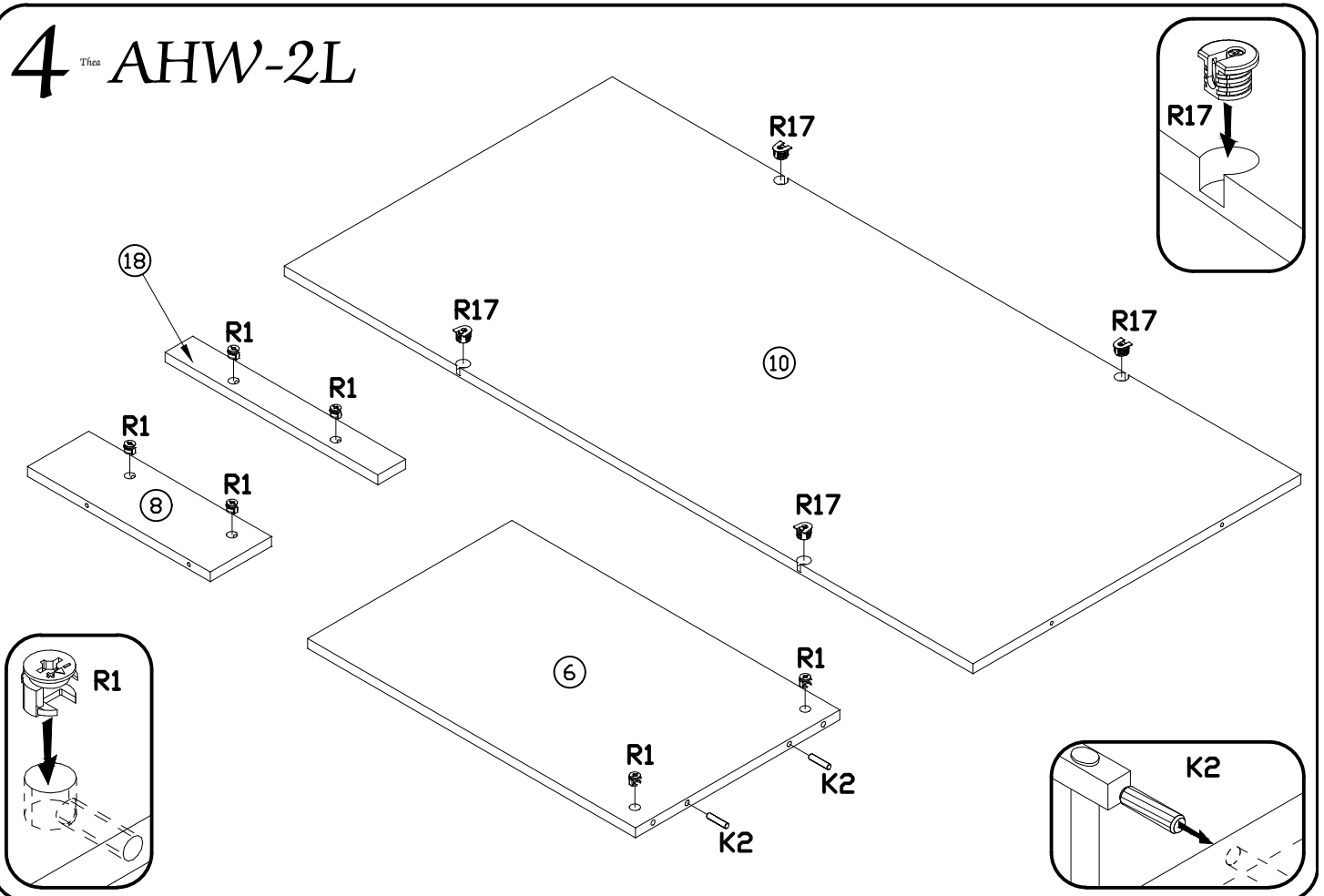

PODCZAS MONTAŻU POSTĘPOWAĆ ZGODNIE Z INSTRUKCJĄ  
 WHILE ASSEMBLING FOLLOW THE INSTRUCTION / MONTAGE LAUT DER AUFBAUANLEITUNG DURCHFÜHREN  
 PŘI MONTÁŽI POSTUPOVAT PODLE NÁVODU / PRI MONTÁŽI POSTUPOJTE PODĽA NÁVODU

# 5<sup>TH</sup> AHW-2L

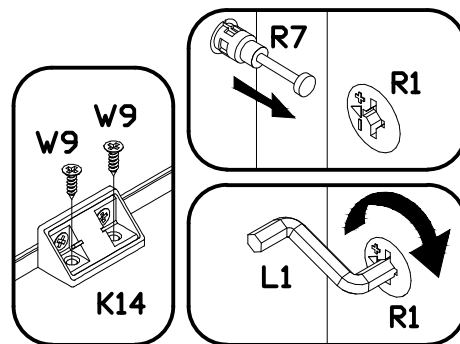
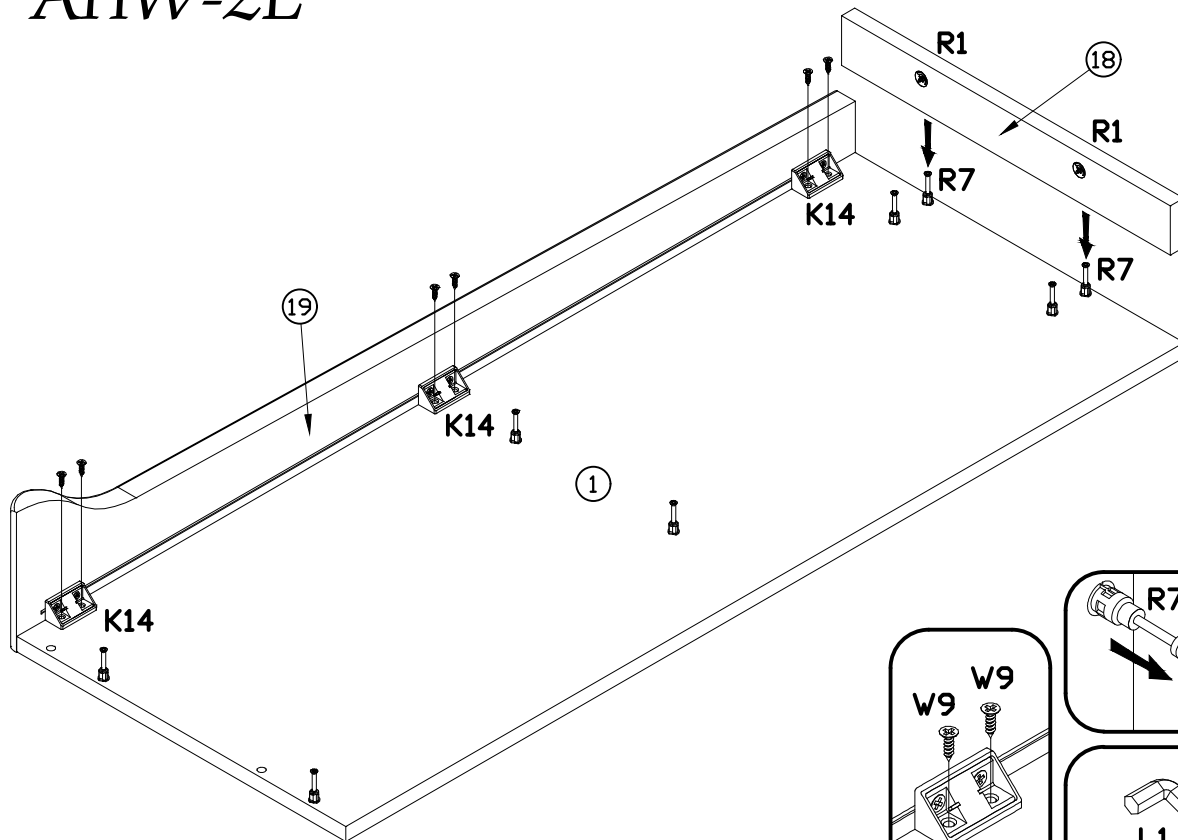

# 6<sup>TH</sup> AHW-2L - Opcja NEO-9

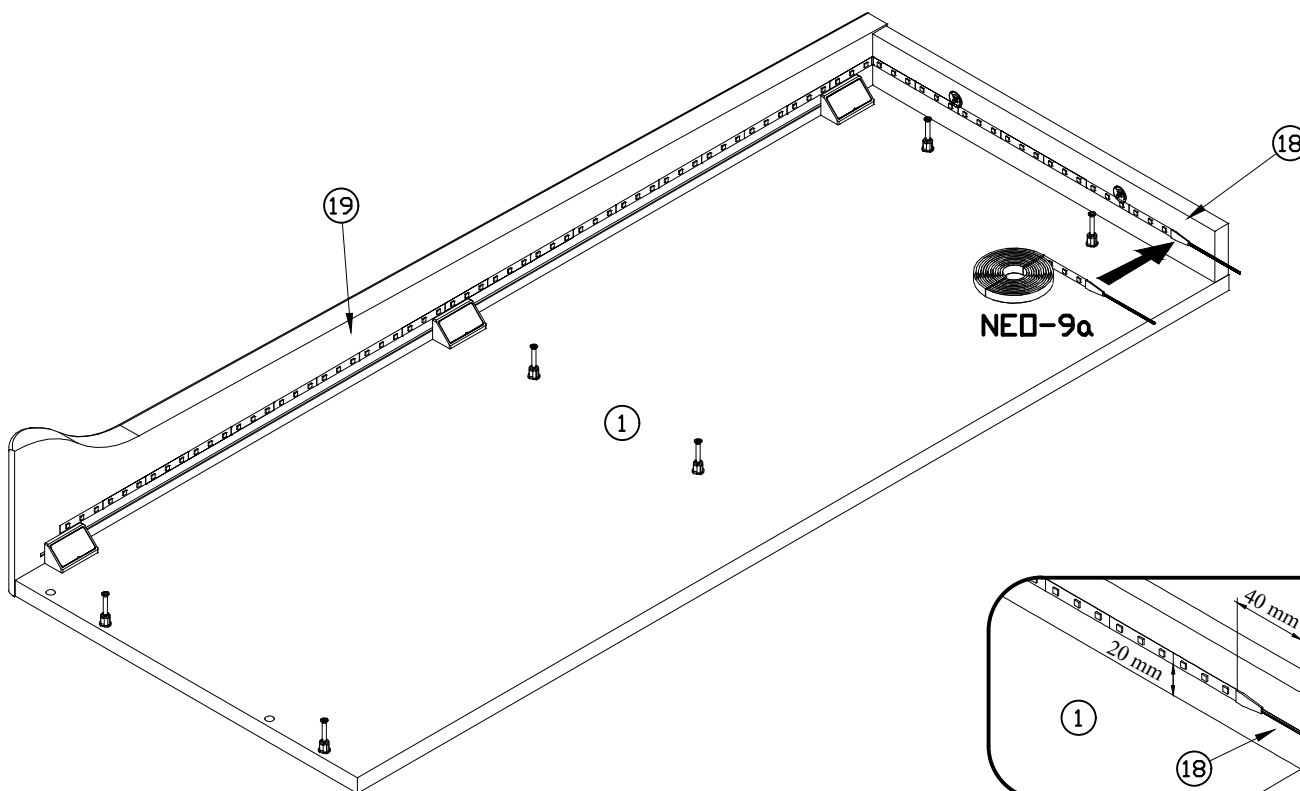
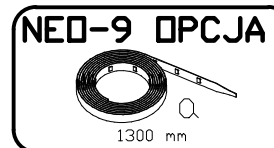

PODCZAS MONTAŻU POSTĘPOWAĆ ZGODNIE Z INSTRUKCJĄ  
 WHILE ASSEMBLING FOLLOW THE INSTRUCTION / MONTAGE LAUT DER AUFBAUANLEITUNG DURCHFÜHREN  
 PŘI MONTÁŽI POSTUPOVAT PODLE NÁVODU / PRI MONTÁŽI POSTUPOJTE PODĽA NÁVODU

# 7<sup>TH</sup> AHW-2L

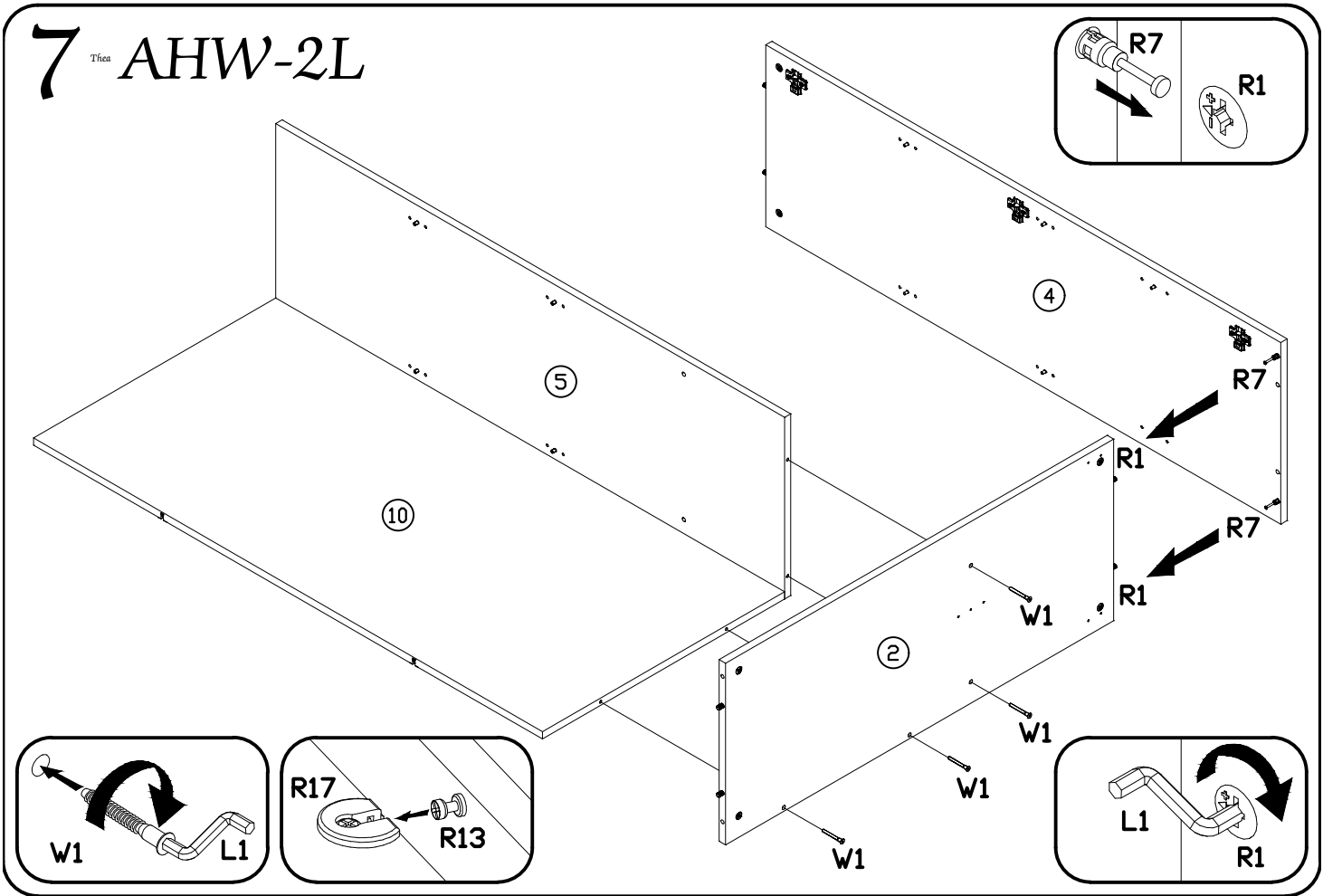

# 8<sup>TH</sup> AHW-2L - Opcja NEO-9

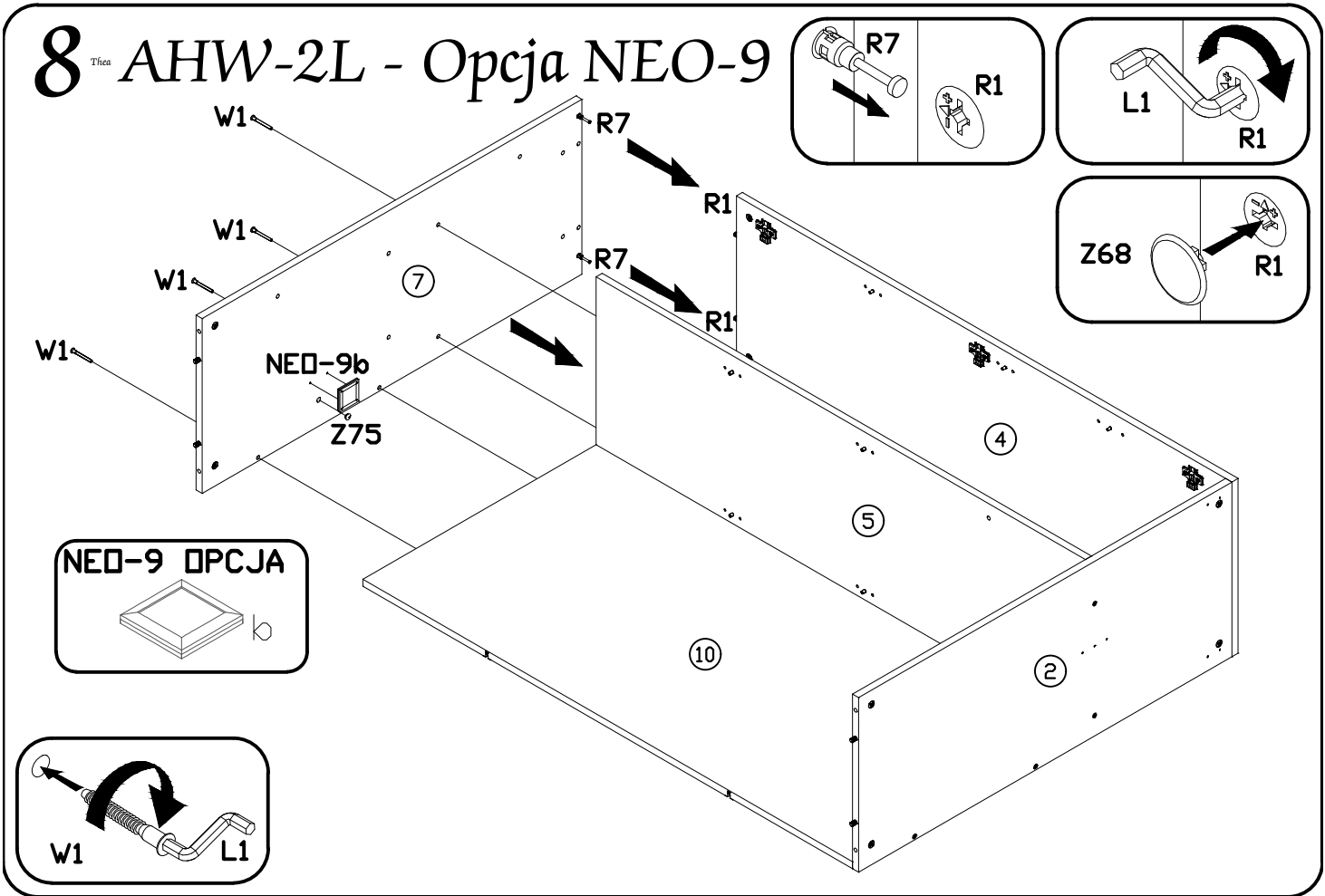

PODCZAS MONTAŻU POSTĘPOWAĆ ZGODNIE Z INSTRUKCJĄ  
 WHILE ASSEMBLING FOLLOW THE INSTRUCTION / MONTAGE LAUT DER AUFBAUANLEITUNG DURCHFÜHREN  
 PŘI MONTÁŽI POSTUPOVAT PODLE NÁVODU / PRI MONTÁŽI POSTUPOJTE PODĽA NÁVODU

# 9<sup>TH</sup> AHW-2L

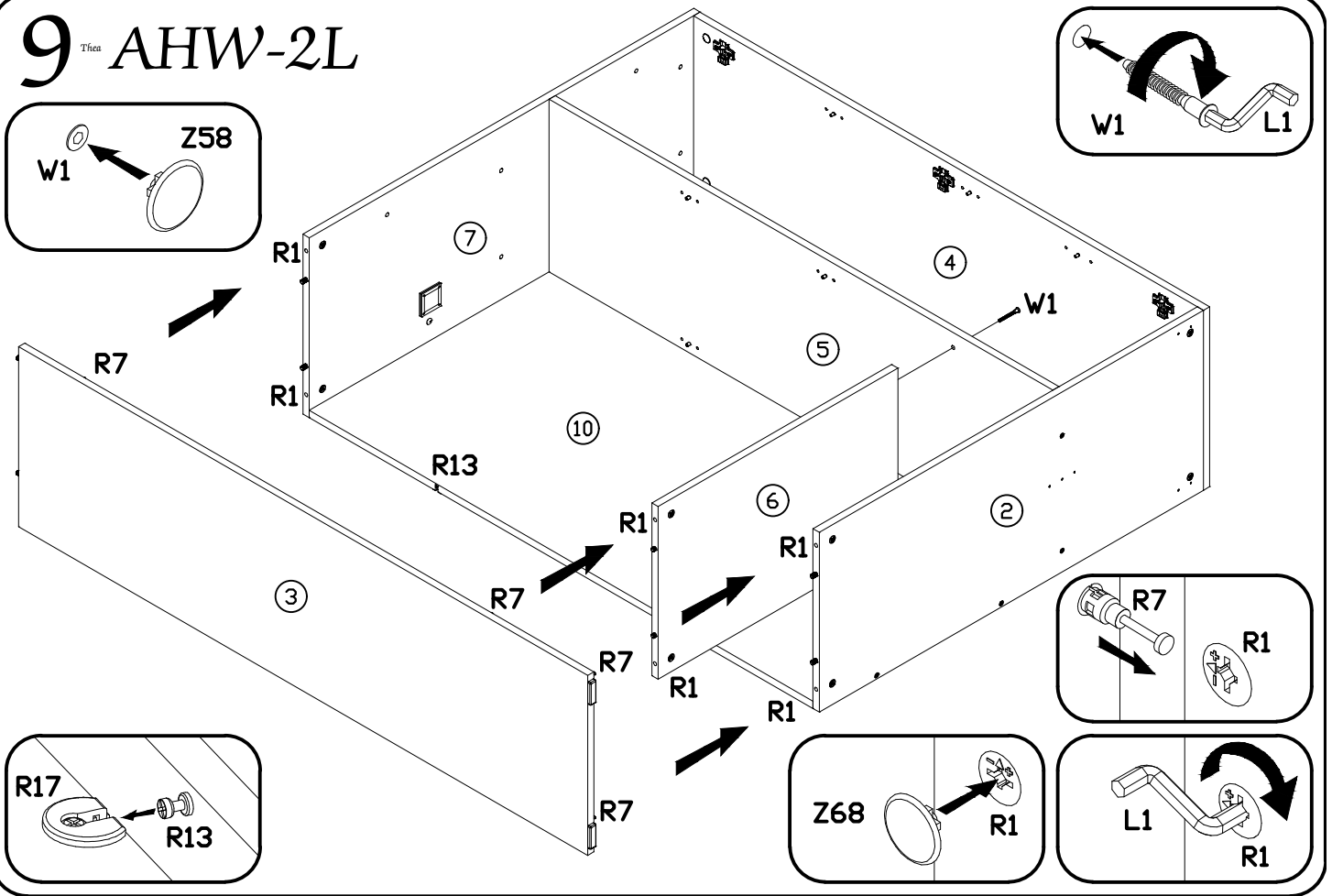

# 10<sup>TH</sup> AHW-2L

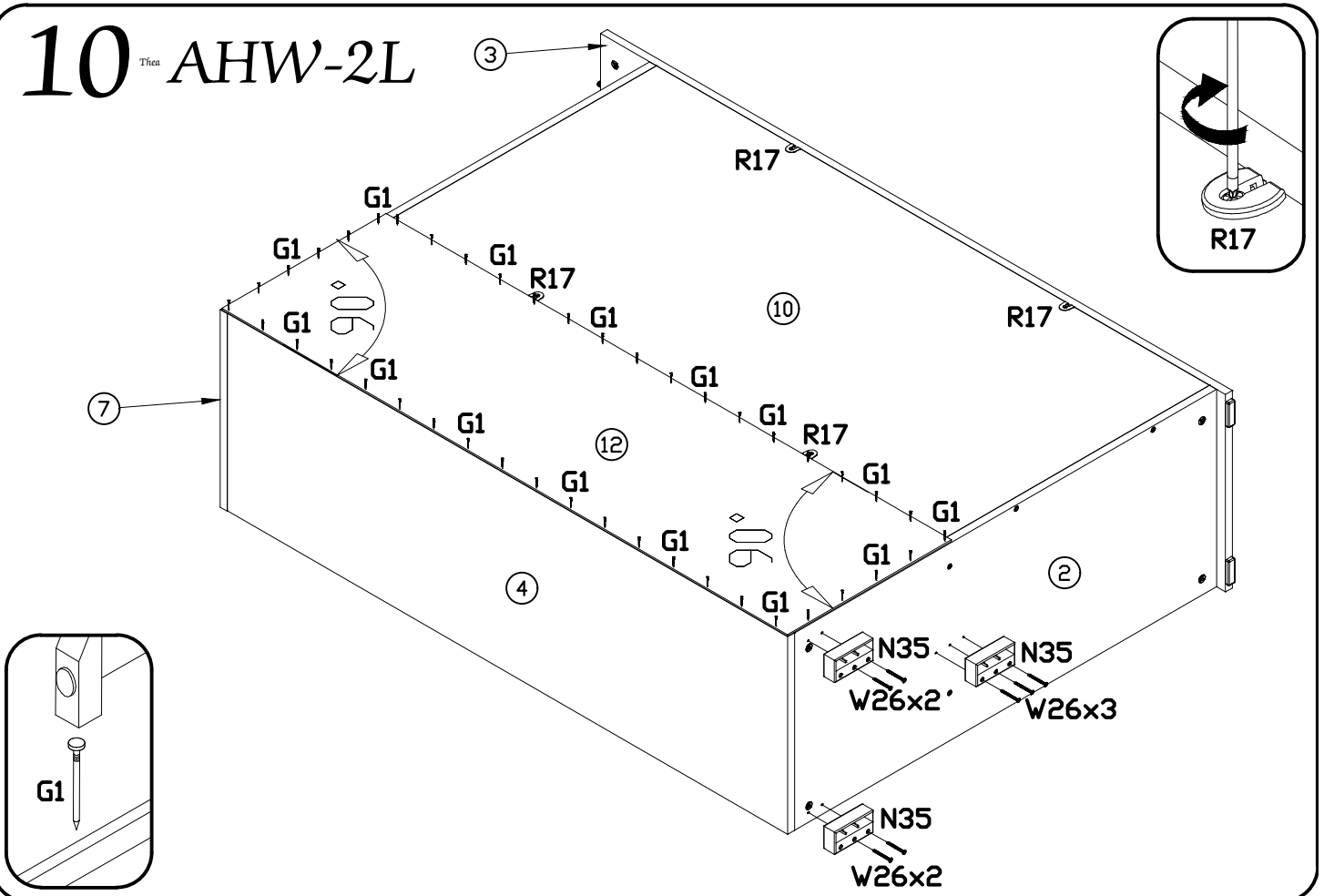

# 11<sup>Třída</sup> AHW-2L

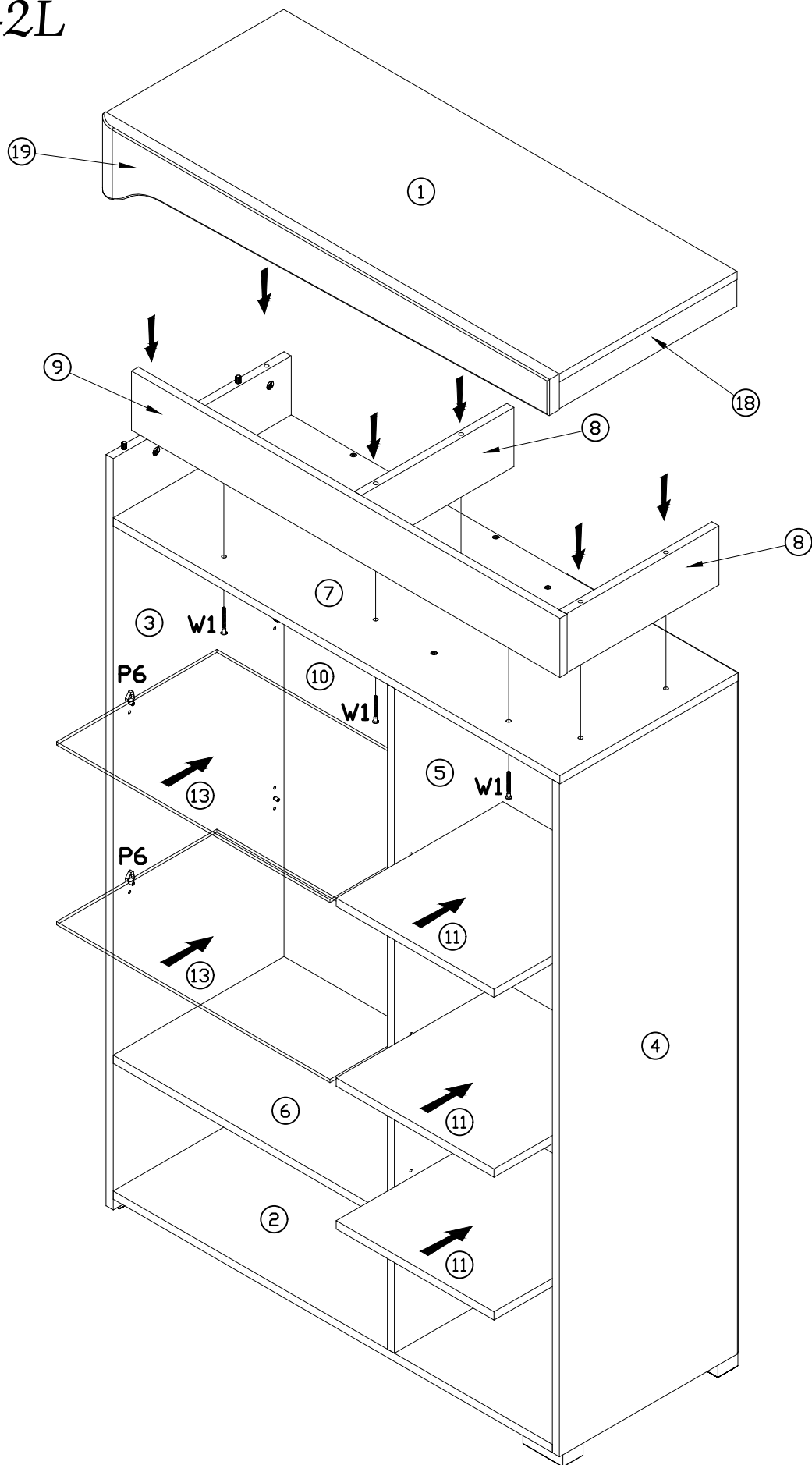
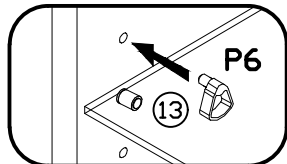
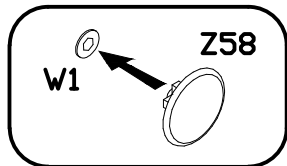
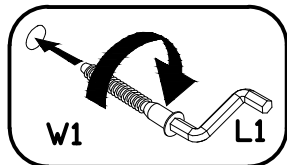
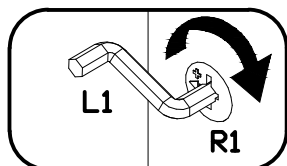
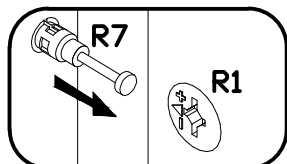



PODCZAS MONTAŻU POSTĘPOWAĆ ZGODNIE Z INSTRUKCJĄ  
 WHILE ASSEMBLING FOLLOW THE INSTRUCTION / MONTAGE LAUT DER AUFBAUANLEITUNG DURCHFÜHREN  
 PŘI MONTÁŽI POSTUPOVAT PODLE NÁVODU / PRI MONTÁŽI POSTUPOJTE PODĽA NÁVODU

# 12<sup>Třída</sup> AHW-2L

