

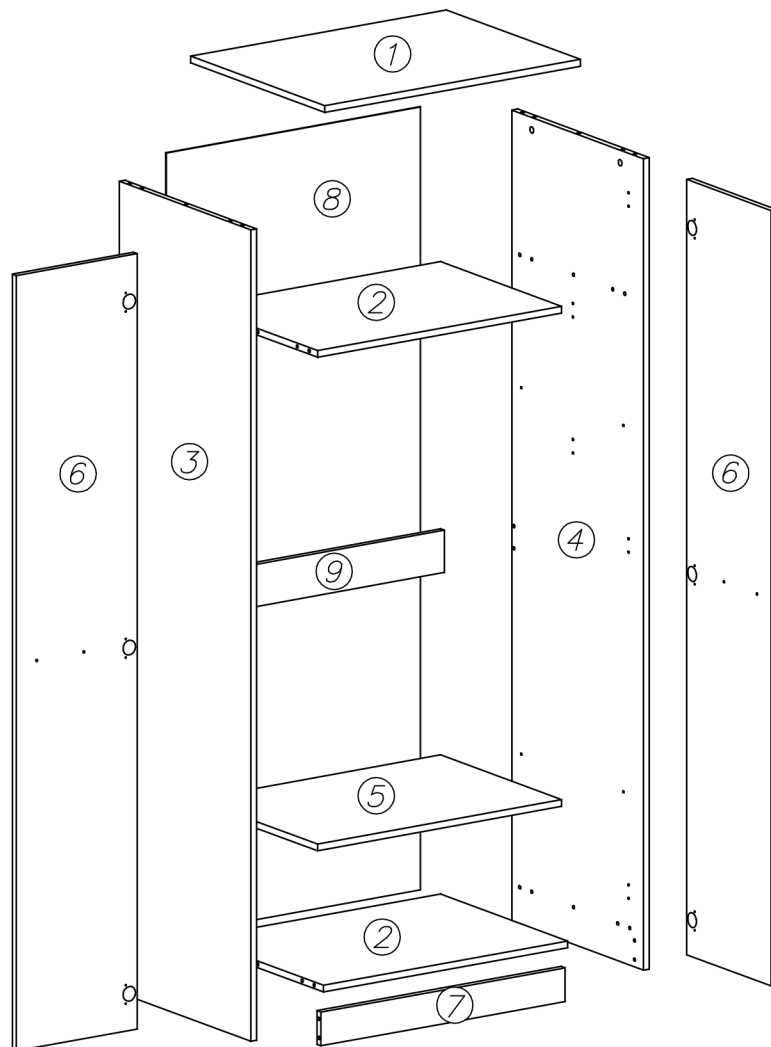

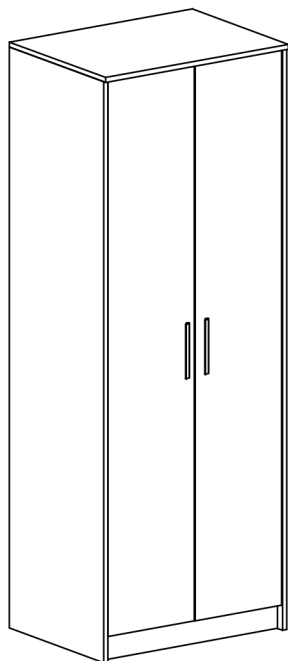

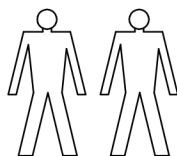

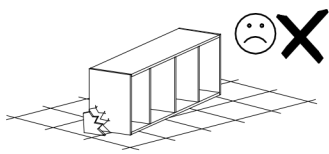

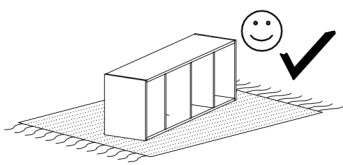
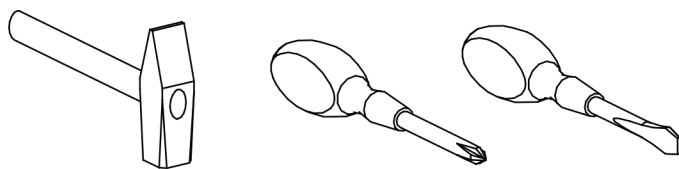

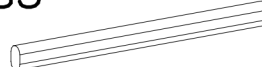
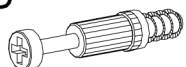

# GRANT 13

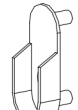

nr	L[mm]	B[mm]	T[mm]	Menge	Colli
1	750	536	16	1	1/1
2	717	504	16	1	1/1
3	1925	526	16	1	1/1
4	1925	526	16	1	1/1
5	717	504	16	1	1/1
6	1843	355	16	2	1/1
7	717	78	16	1	1/1
8	1858	371	3	2	1/1
9	717	100	16	1	1/1

<b>E13</b>  x2	<b>S5</b>  x1	<b>K5</b>  x14
--------------------------------------------------------------------------------------------------------	--------------------------------------------------------------------------------------------------------	---------------------------------------------------------------------------------------------------------

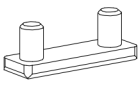
<b>N15</b>  M4x25 x4	<b>G4</b>  4x16 x14	<b>K1</b>  ø15x12 x14	<b>B1</b>  ø8x35 x24	<b>C4</b>  Z350D x6
---------------------------------------------------------------------------------------------------------------	--------------------------------------------------------------------------------------------------------------	----------------------------------------------------------------------------------------------------------------	-----------------------------------------------------------------------------------------------------------------	----------------------------------------------------------------------------------------------------------------

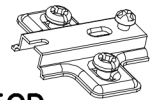
<b>S8</b>  x2	<b>F1</b>  x4	<b>P3</b>  x4	<b>W4</b>  x60	<b>D4</b>  PZ350D x6
--------------------------------------------------------------------------------------------------------	--------------------------------------------------------------------------------------------------------	--------------------------------------------------------------------------------------------------------	----------------------------------------------------------------------------------------------------------	-----------------------------------------------------------------------------------------------------------------

1

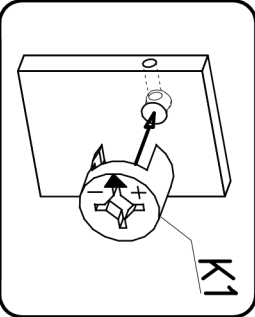
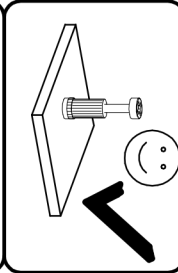
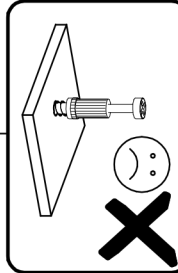
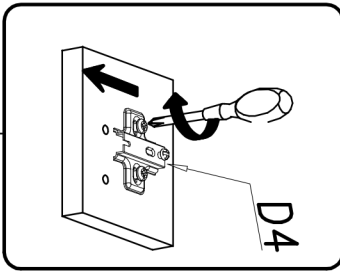
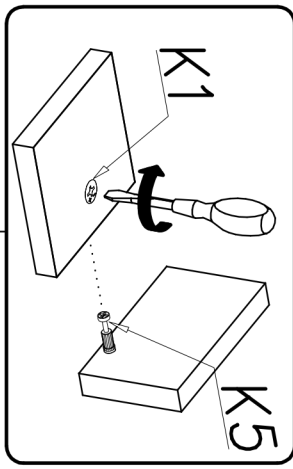
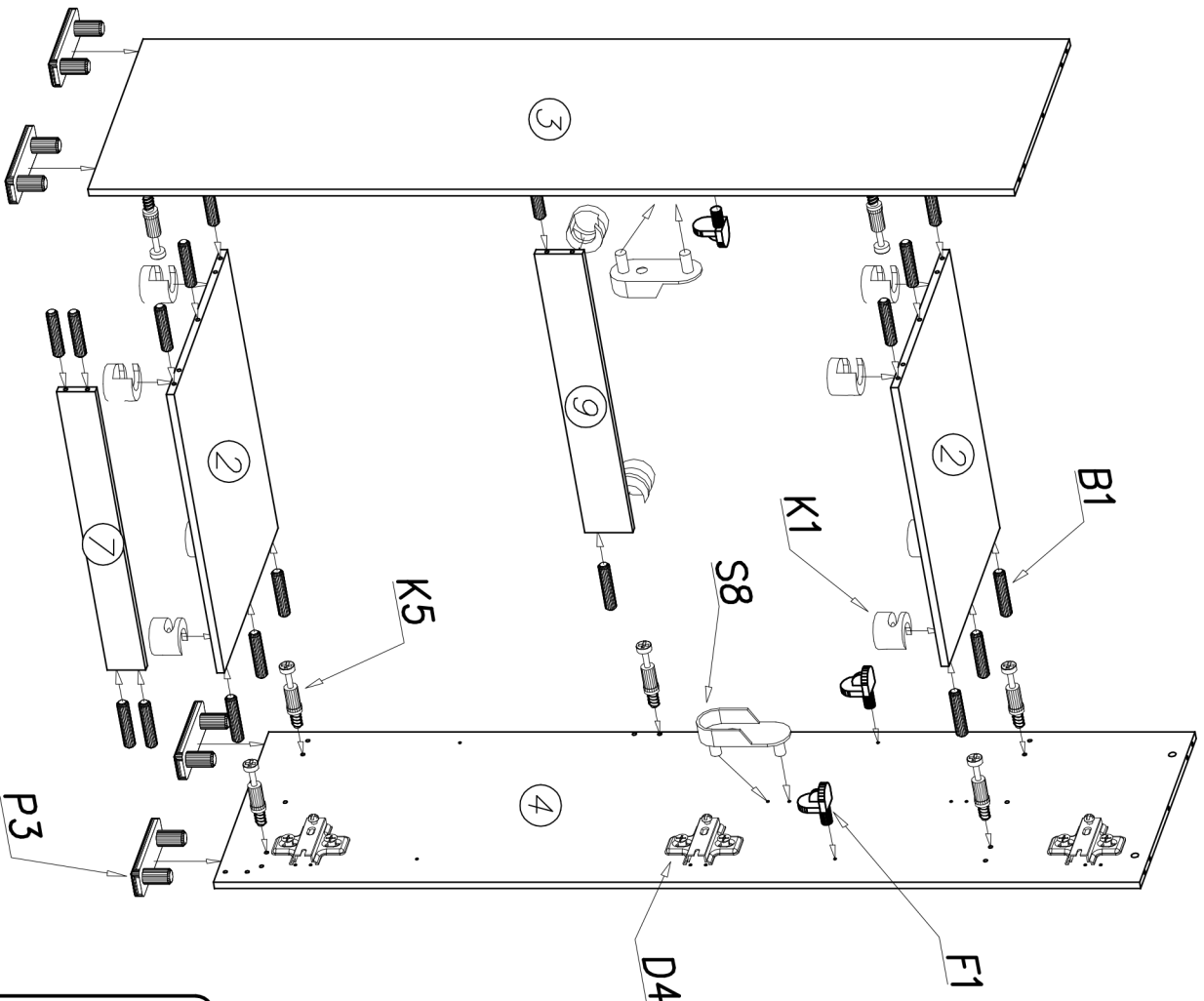

2

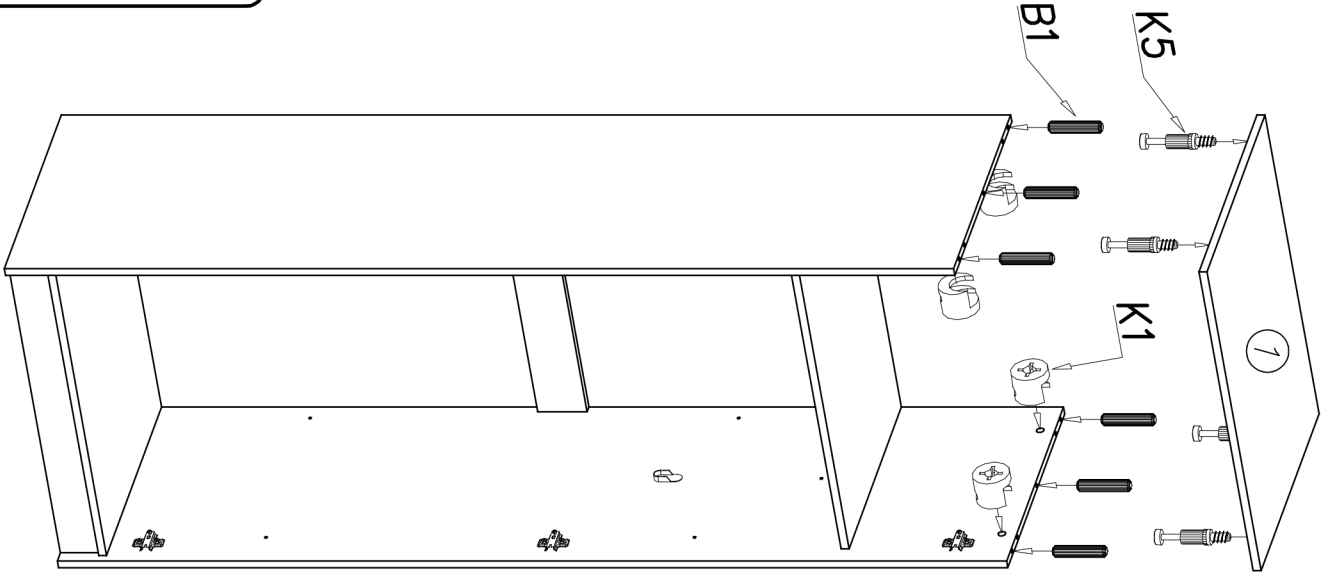

3

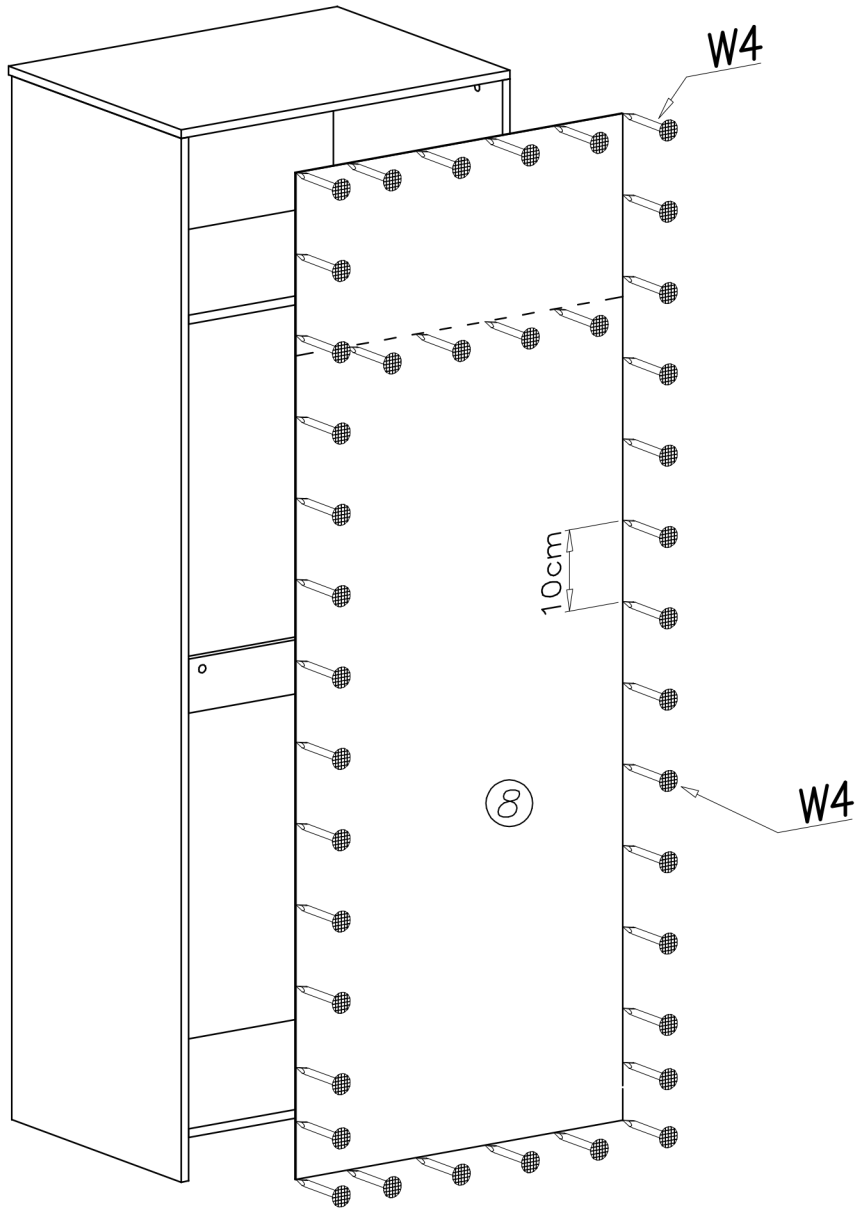

4

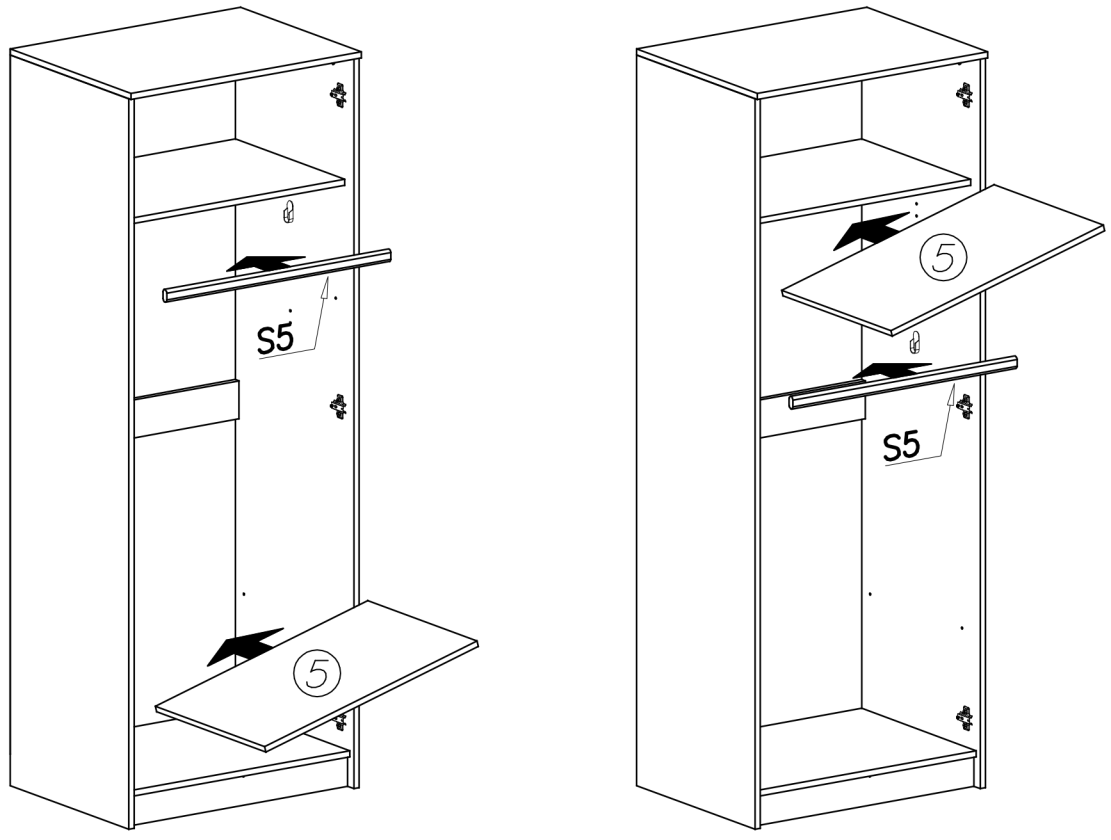

5

