

MONTAGEANLEITUNG INSTRUKCJA MONTAŻOWA

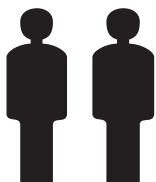

2 Personen
2 Osoby

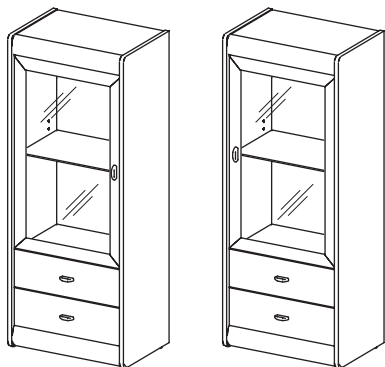
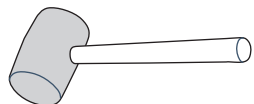
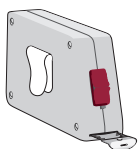

TYPE "L" TYPE "R"

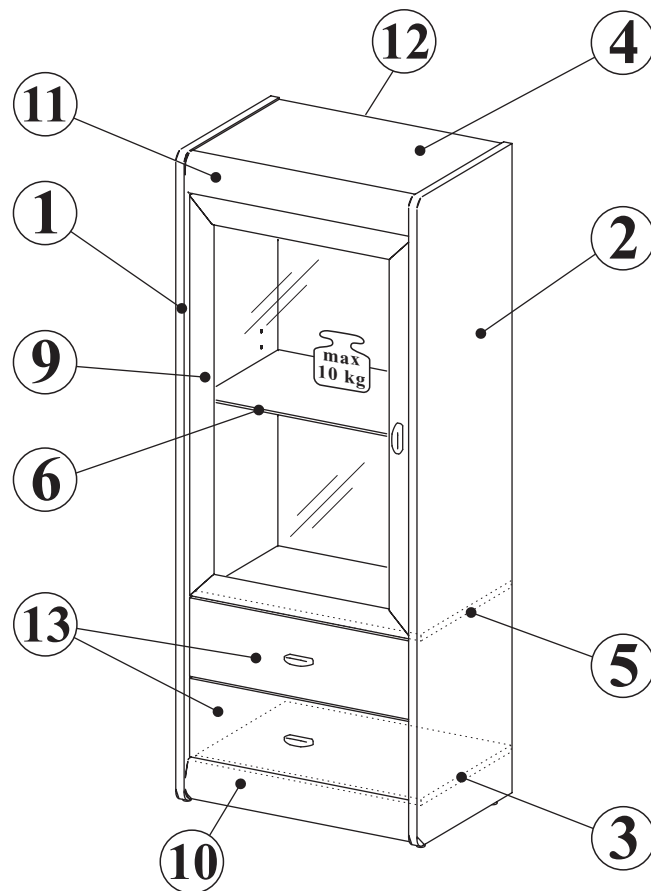

**MONTOWAĆ
 NA ROZŁOŻONYM KARTONIE!**

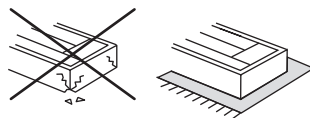

















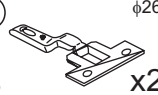







**Wskazówka dotycząca
 pielęgnacji!**

Proszę czyścić tylko suchą
 lub lekko wilgotną szmatką do kurzu.
 Nie używać żadnych środków szorstkich!
 Maksymalne obciążenie półek w kg:

Stärke/Gr.	Spanplatte/Płyta		
Länge/Dł. mm	15	18	22
0<400			
401<600	40	40	40
601<800	24		
801<1000	15	30	



- F15**  x4
- L10**  x2
- F6**  x2
- P13**  3,5x13 mm x4
- J44**  x1
- P13**  3,5x13 x1
- G22**  φ18 x2
- T13**  φ8 x1
- S15**  4x45 x1
- Y1**  φ26 KR15 x2
- Y5**  H2 x2
- E1**  6,3x13 x4
- S8**  4x13 x4
- B1**  φ 8x28 x16
- M1**  x16
- T1**  x16
- C2**  x16
- W2**  x4
- P33**  x41
- R1**  L-246 mm x4
- E4**  6,0x8,0 x8
- A1**  M4x9 mm x4
- J23**  x8
- U16**  x3
- A2**  M4x22 x6
- L1**  Klej x1

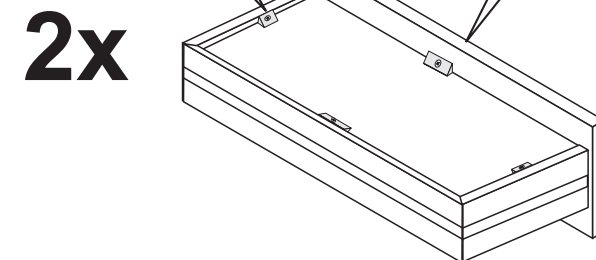
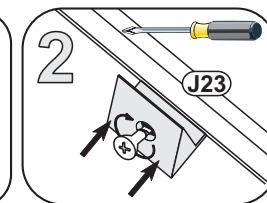
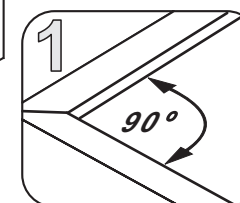
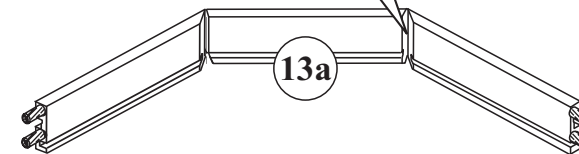
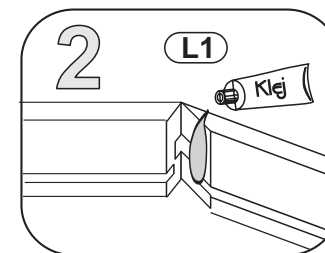
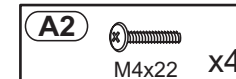
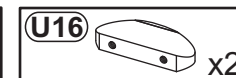
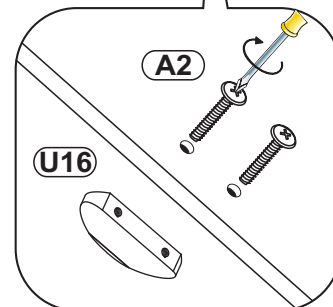
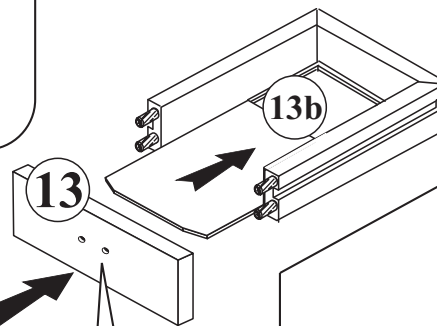
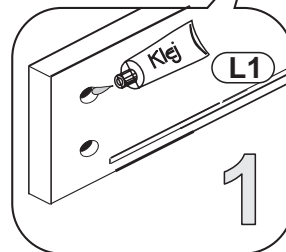
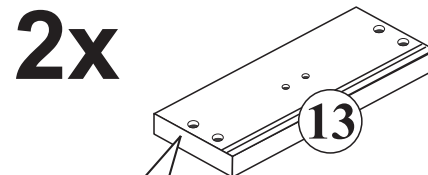
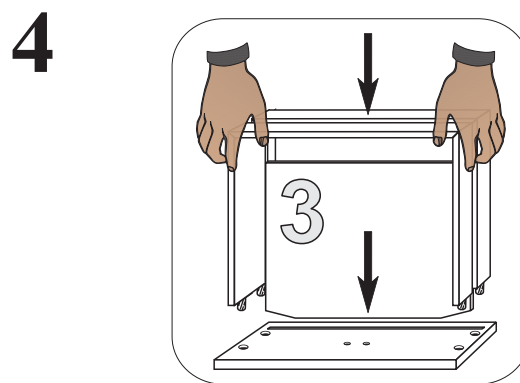
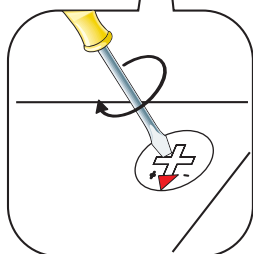
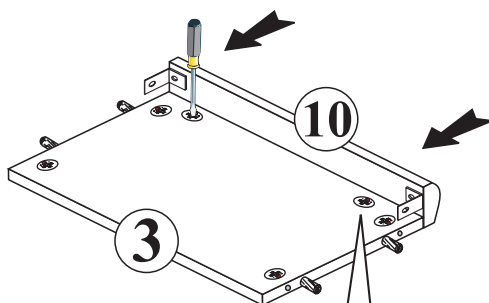
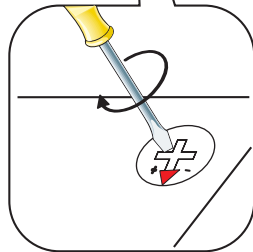
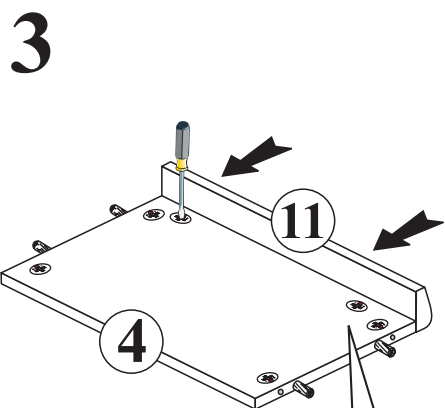
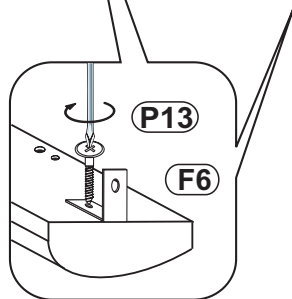
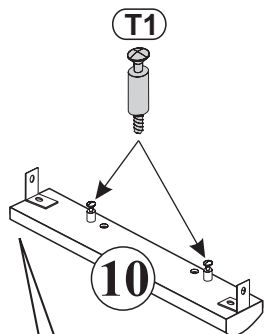
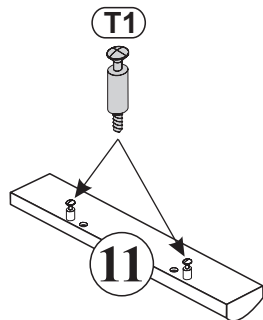
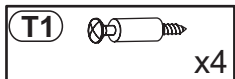
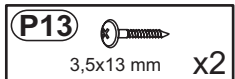

6

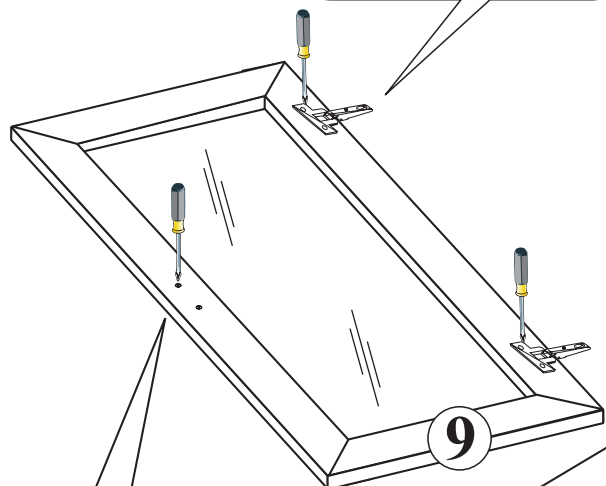
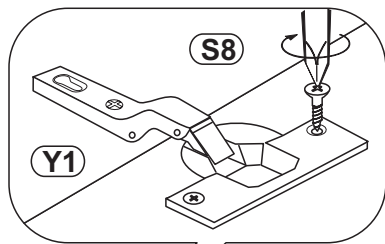
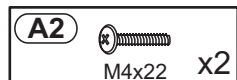
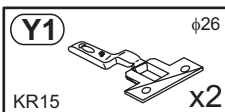
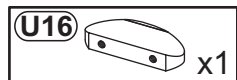

9

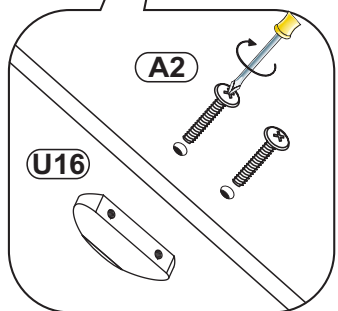

7

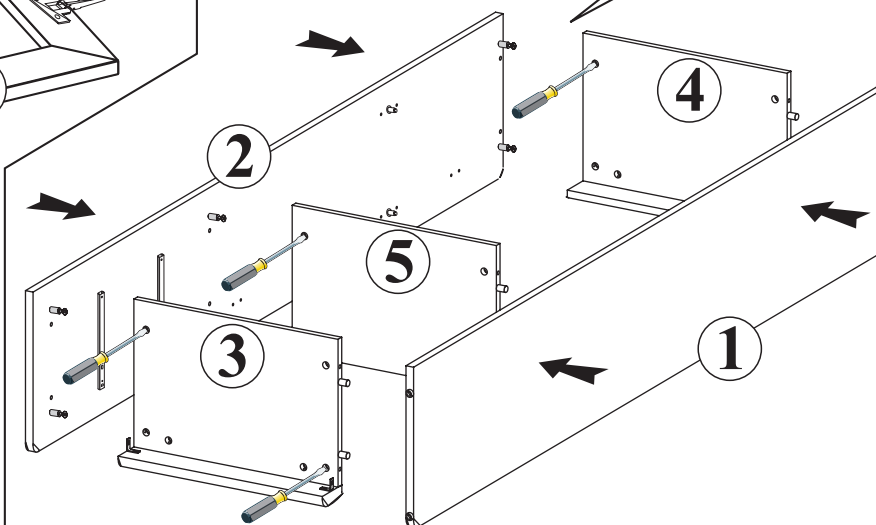
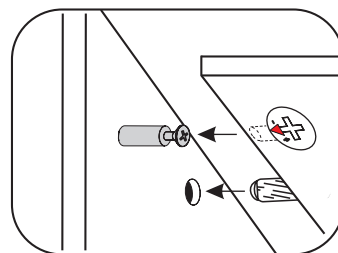
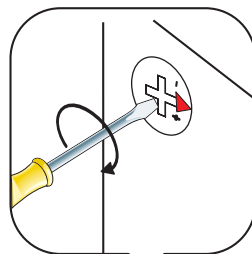
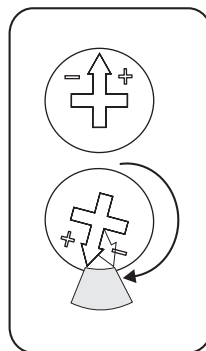

8

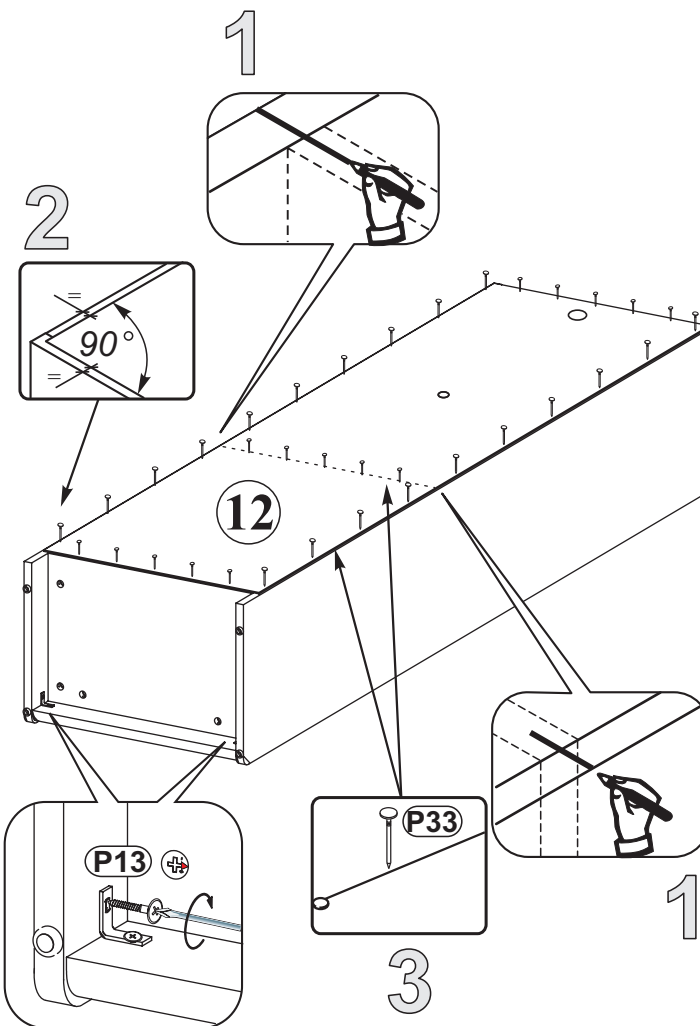
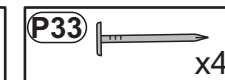
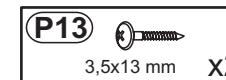

9

