

system **DALLAS**

D-8

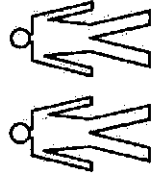

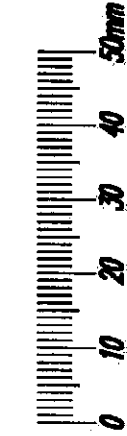



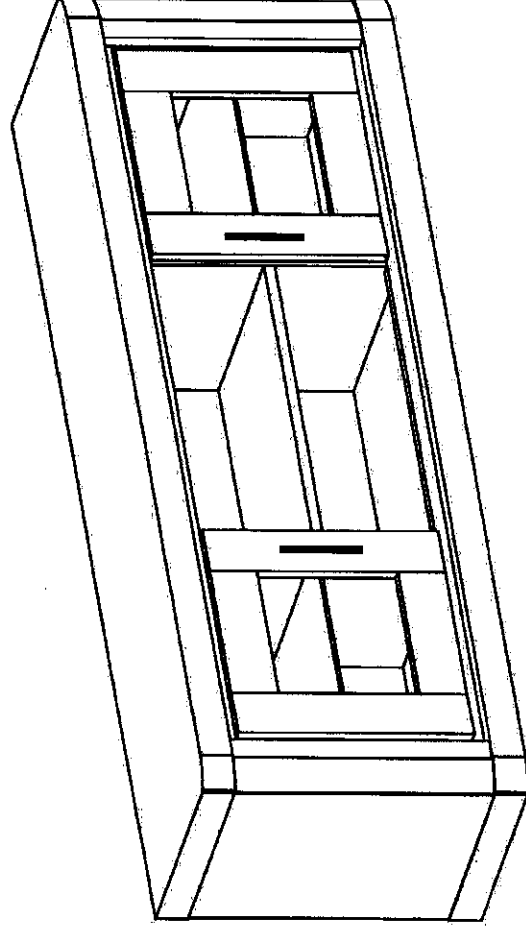
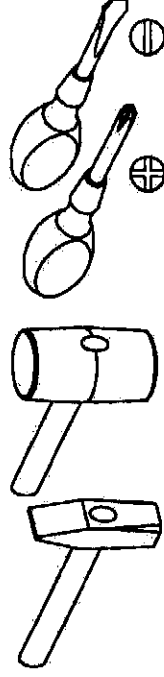







INSTRUKCJA MONTAŻU

Narzędzia potrzebne do montażu

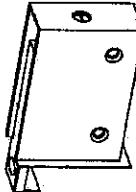

W przypadku reklamacji proszę o podanie numeru pakowacza znajdującego się na kartonie

 N - 4 St. 4 x 30 mm	 U - 2 St.	 G - 8 St. 3,5 x 16 mm	 L - 20 St.
 E - 35 St.	 C - 4 St.	 D - 4 St.	 R - 8 St. 4 x 30 mm
 B - 16 St.	 K - 20 St.	 Z - 1 St.	 P - 12 St.
 T - 4 St.			

I

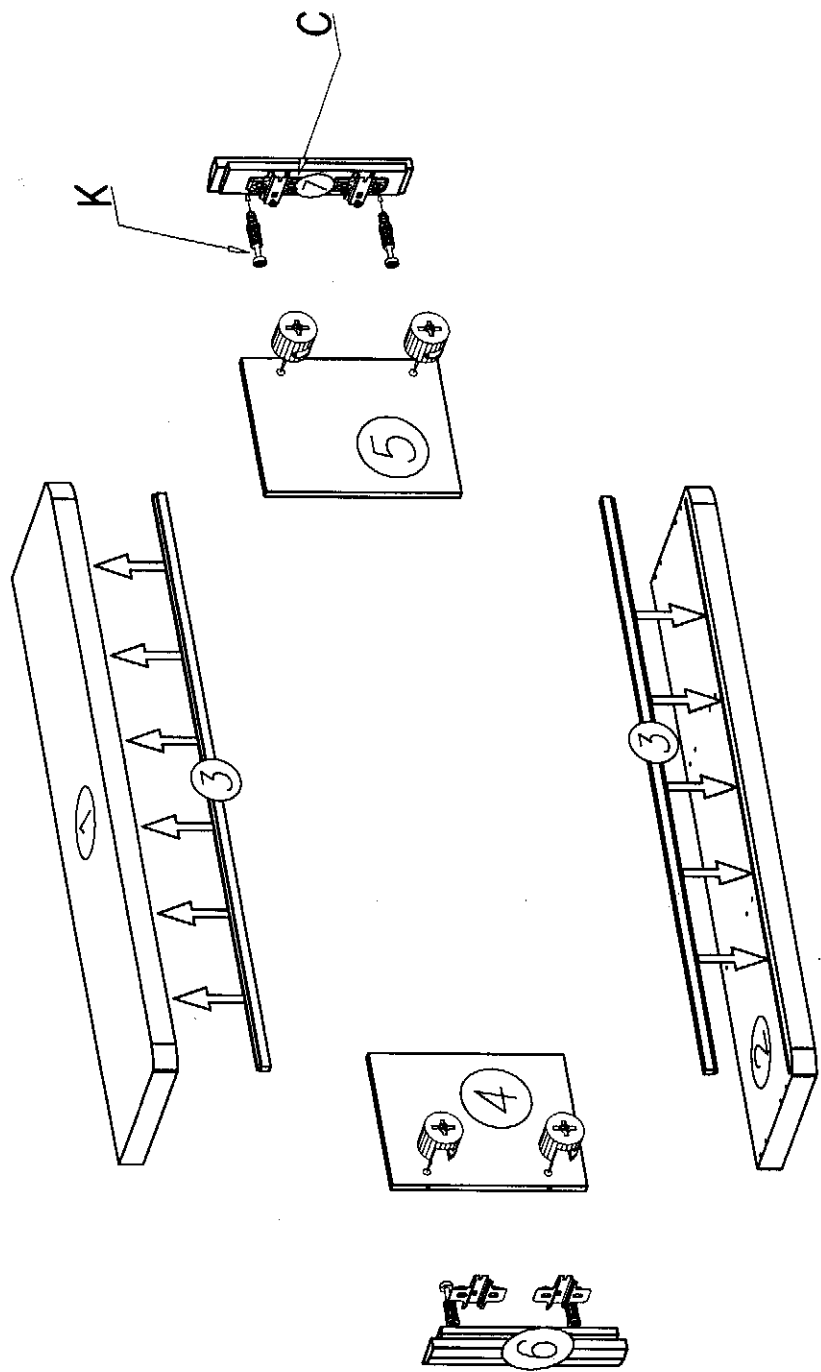

II

