

system DALLAS

D-23

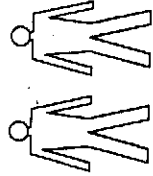

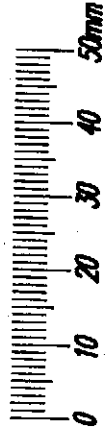



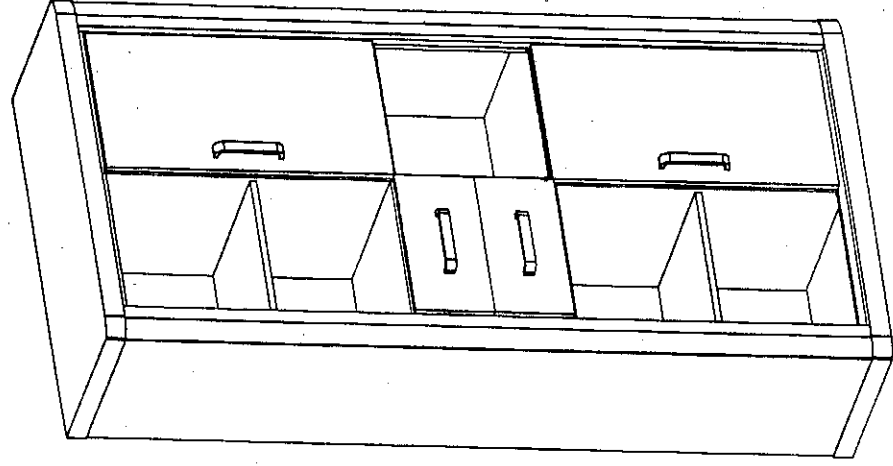
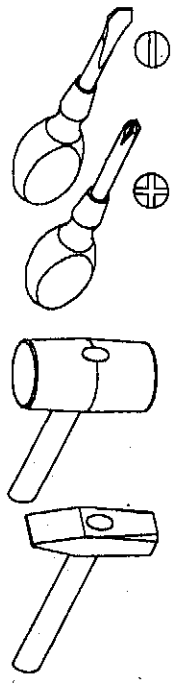



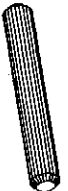



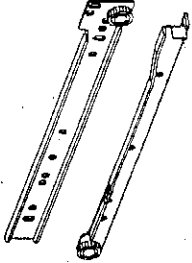
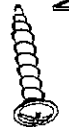

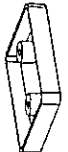

INSTRUKCJA MONTAŻU

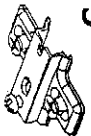
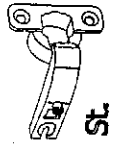
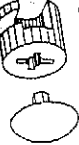
Narzędzia potrzebne do montażu



W przypadku reklamacji proszę o podanie numeru pakowacza znajdującego się na kartonie

 R - 4 St.	 P - 16 St.	 M - 16 St. 4 x 25 mm	 H - 15 St.	 W - 8 St.
 T - 2 Kpl.	 N - 8 St. 4 x 30 mm	 U - 4 St.	 G - 23 St. 3,5 x 16 mm	 F - 8 St.
 A - 4 St.	 E - 80 St.	 C - 4 St.	 D - 4 St.	 L - 20 St.
 B - 24 St.	 K - 20 St.	 Z - 1 St.	 KLEJ	 S - 1 St.
				 J - 8 St. 5 x 13 mm

I

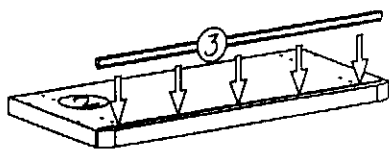
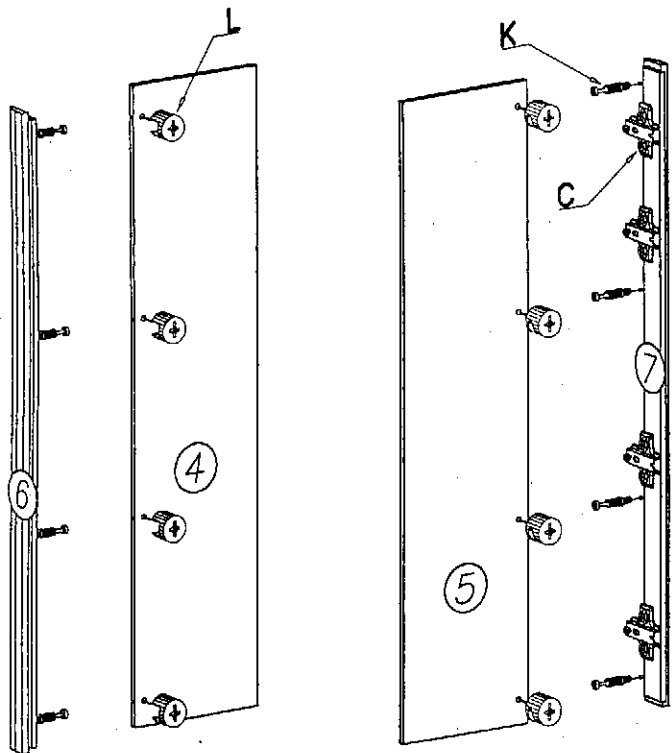
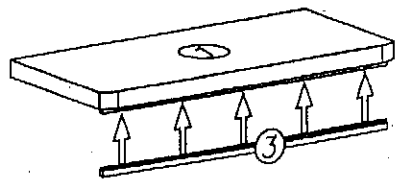

II

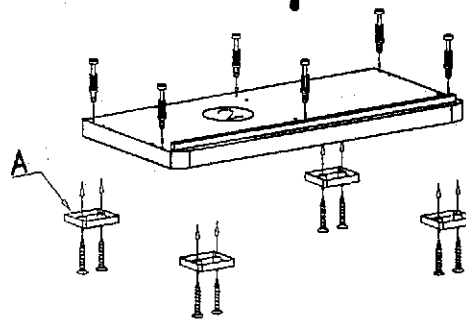
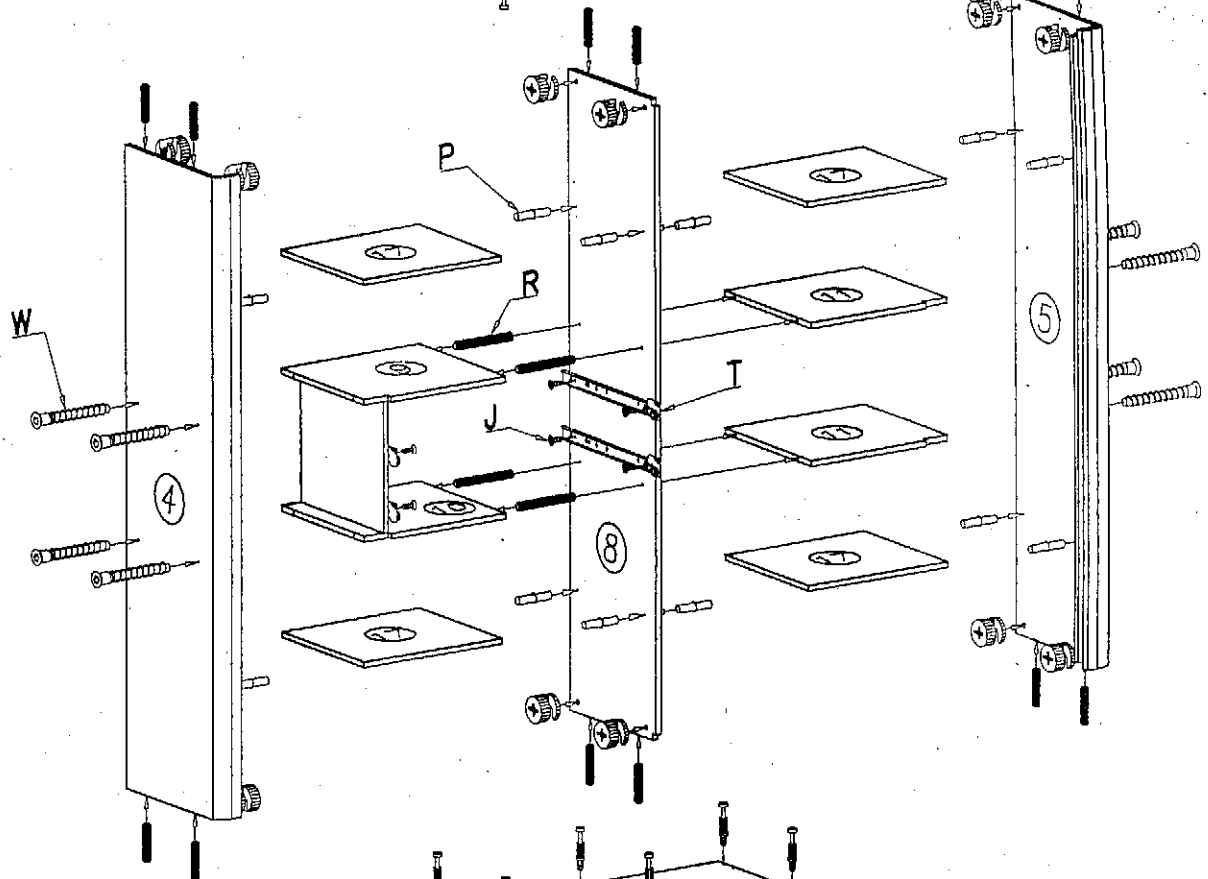
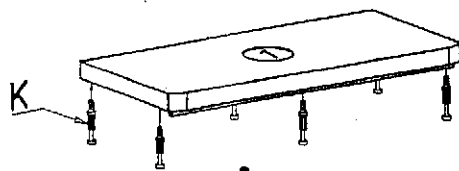

III

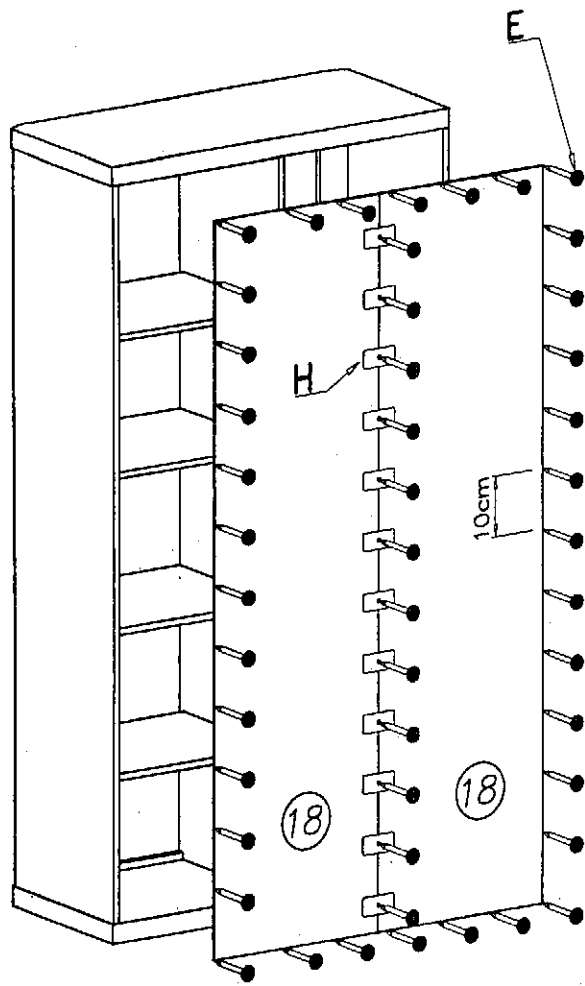

IV

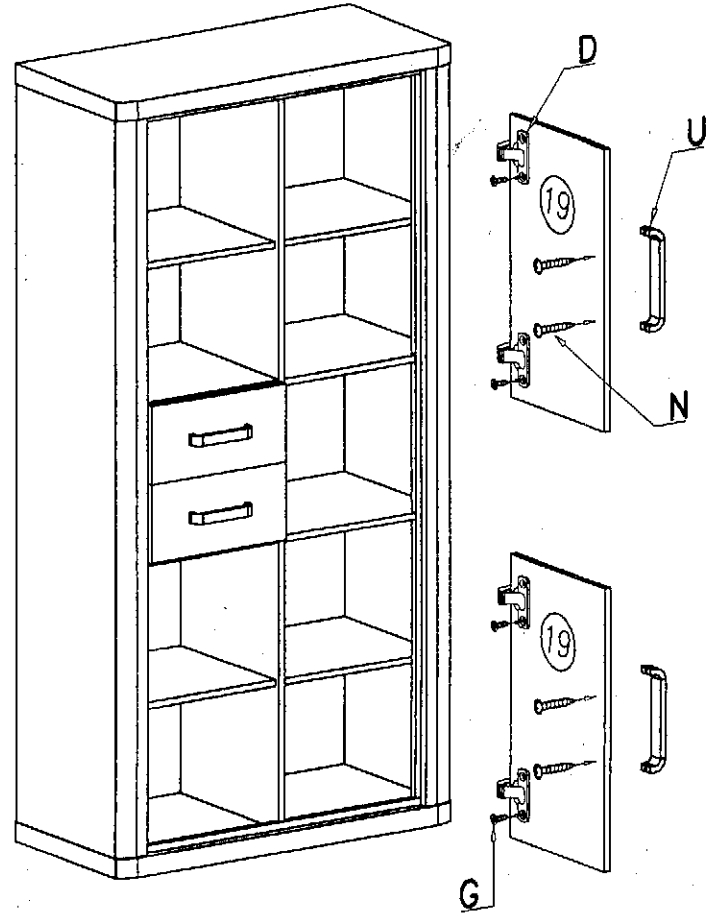

V

