

ASTON 4

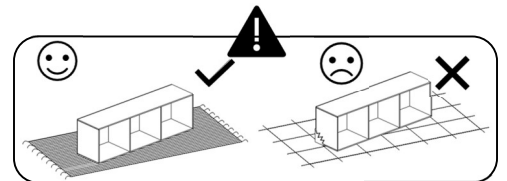

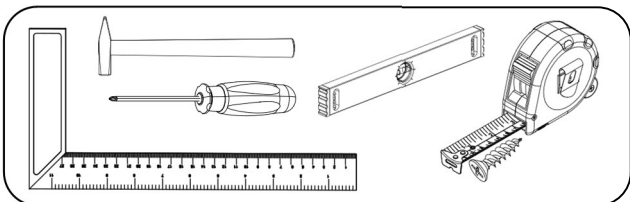

No	T(mm)	L(mm)	W(mm)	Stc.
1	16	890	402	1
2	16	890	402	1
3	16	968	358	1
4	16	578	358	1
5	16	968	358	1
6	16	200	288	1
7	16	1002	403	1
8	16	710	480	1
9	16	968	80	1
10	16	476	350	1
11	3	814	488	2
12	16	480	200	3
13	16	418	140	3
14	3	432	348	3
15	16	350	140	3
16	16	350	140	3

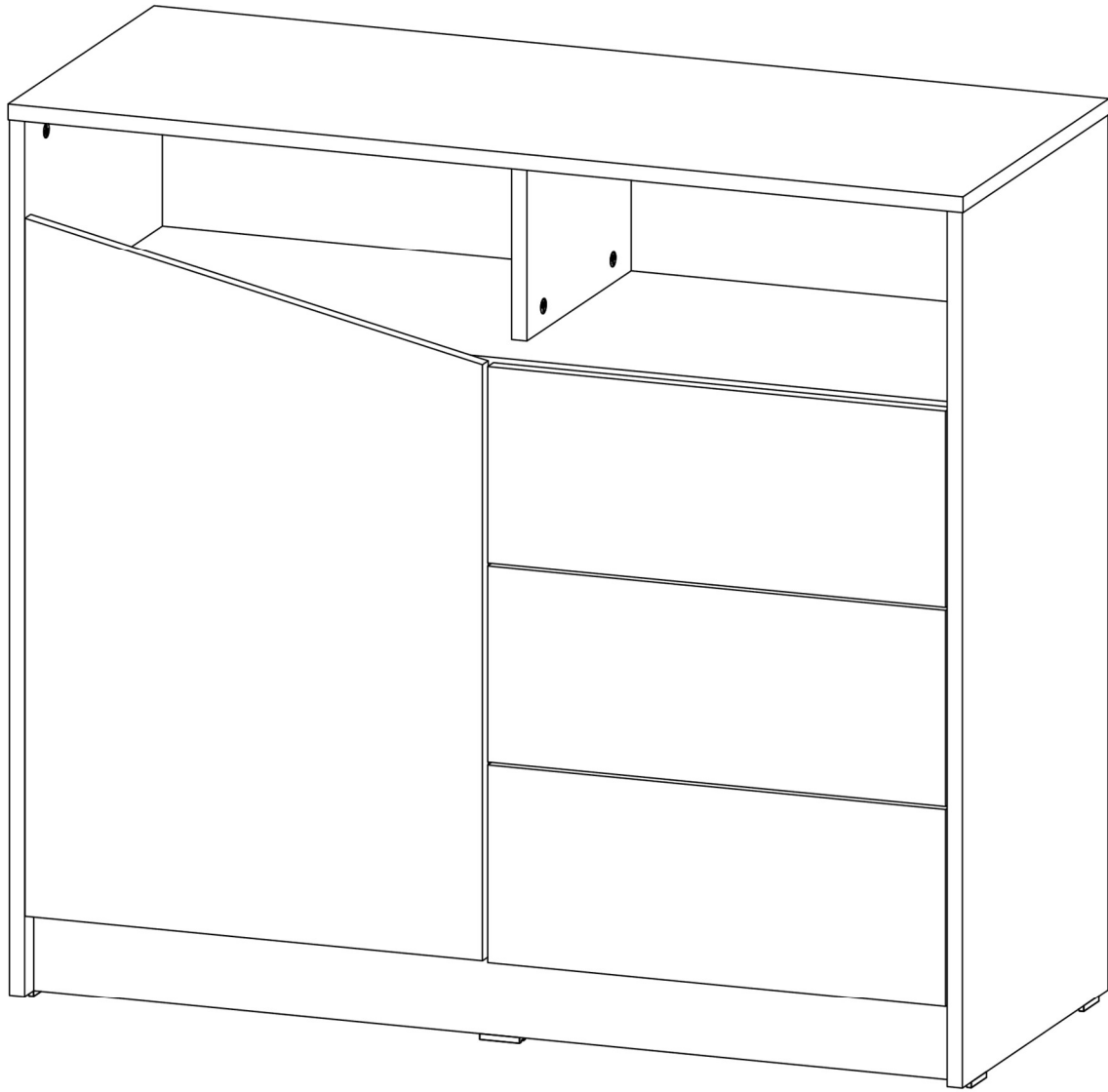
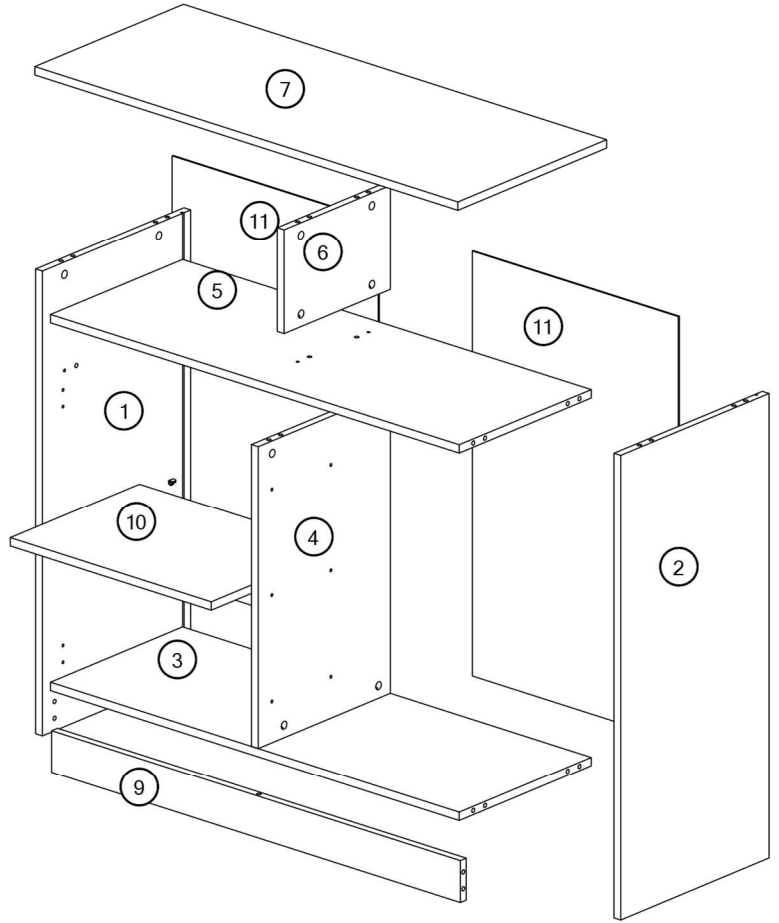
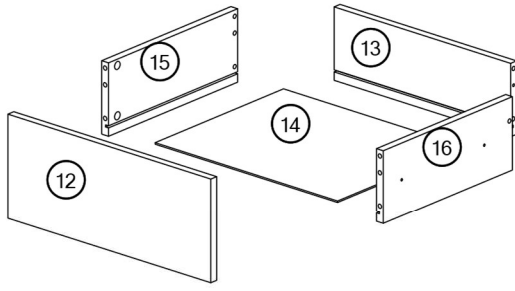
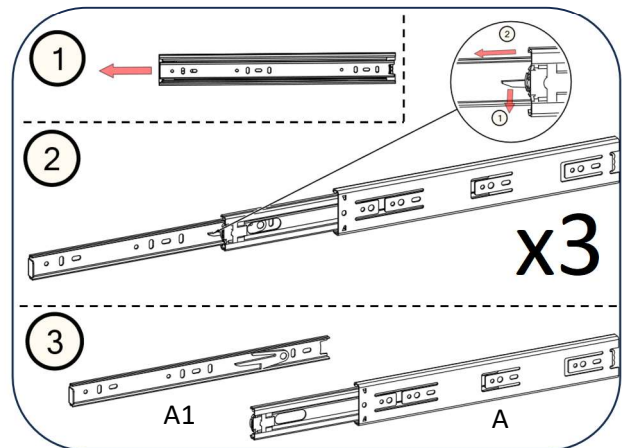
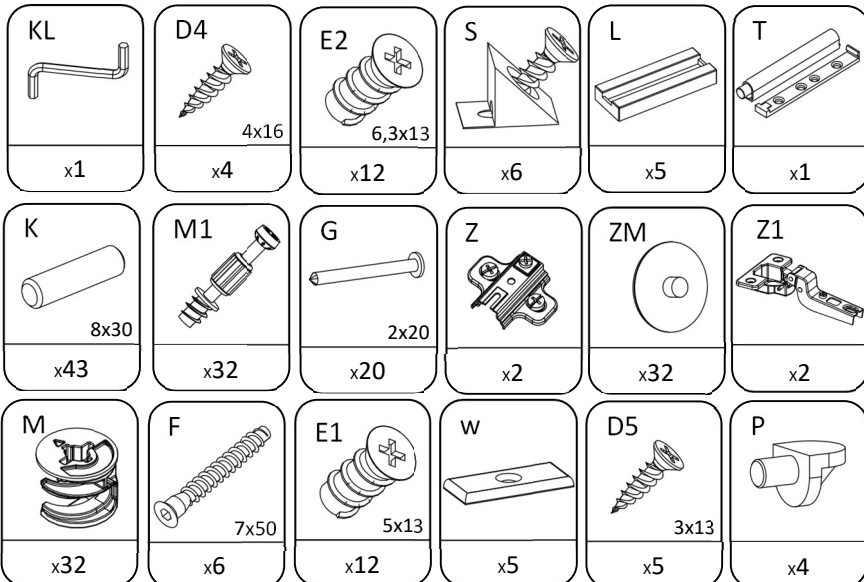
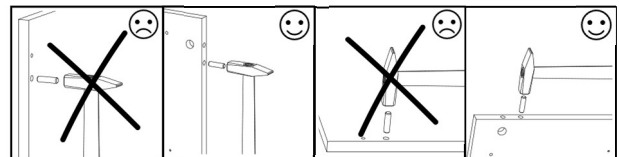
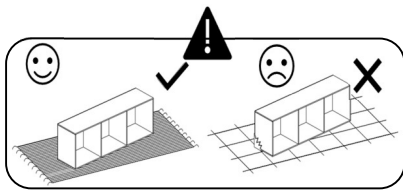

1

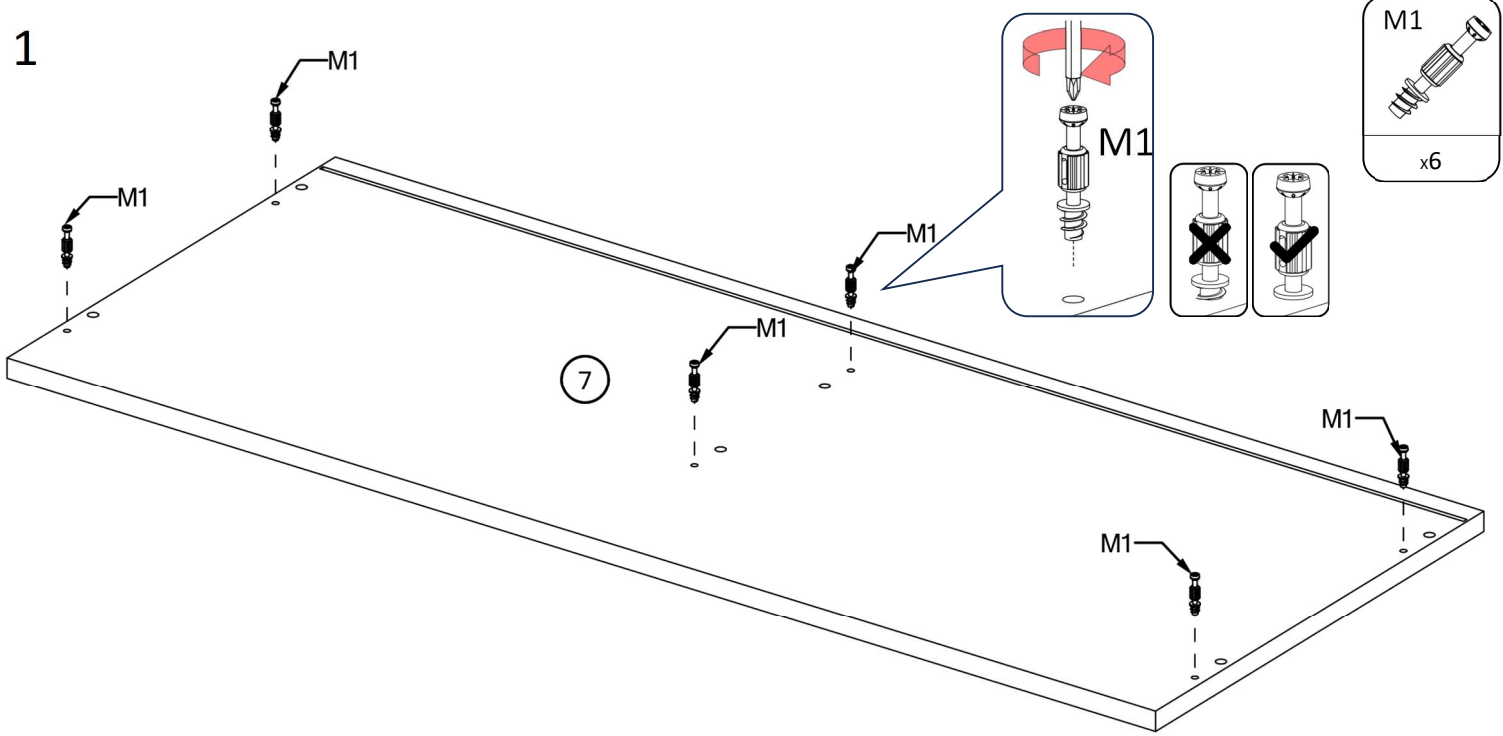

2

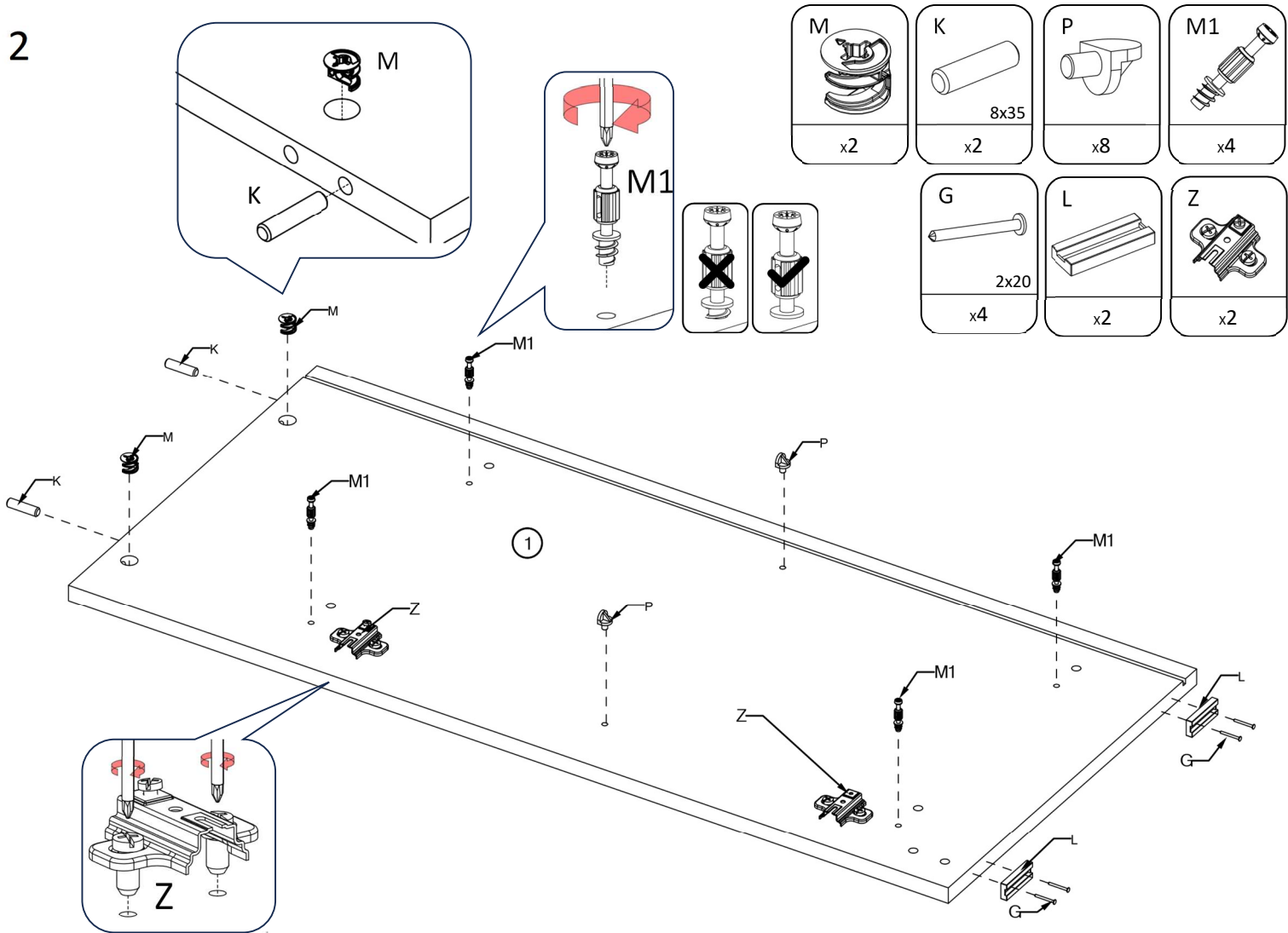

3

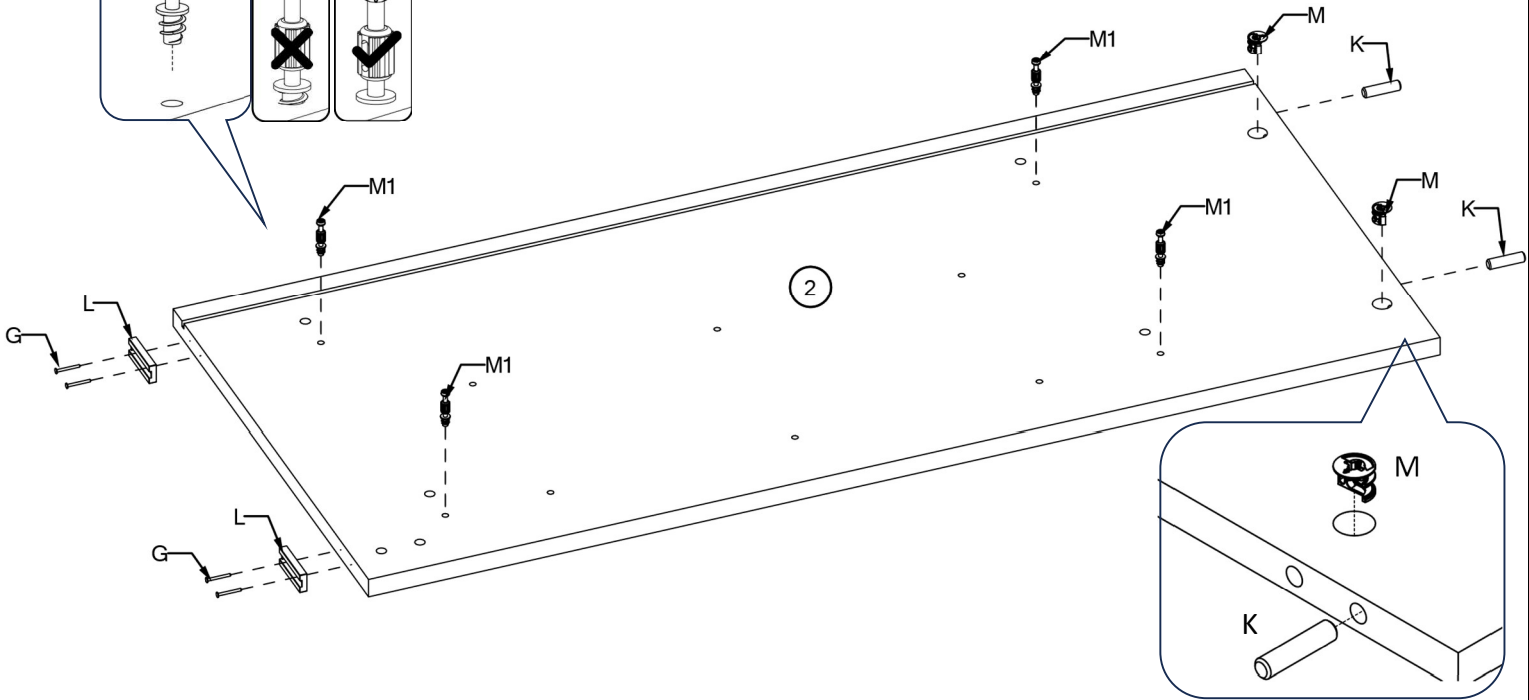
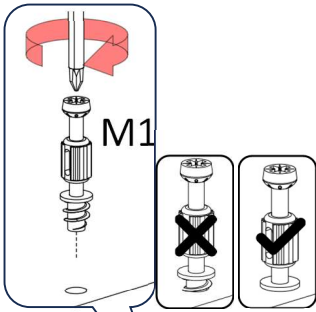
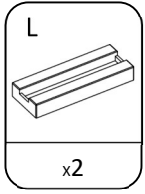
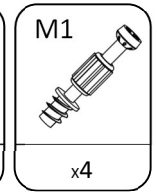
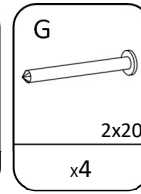
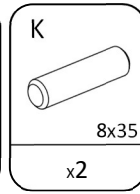
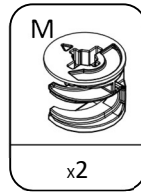

4

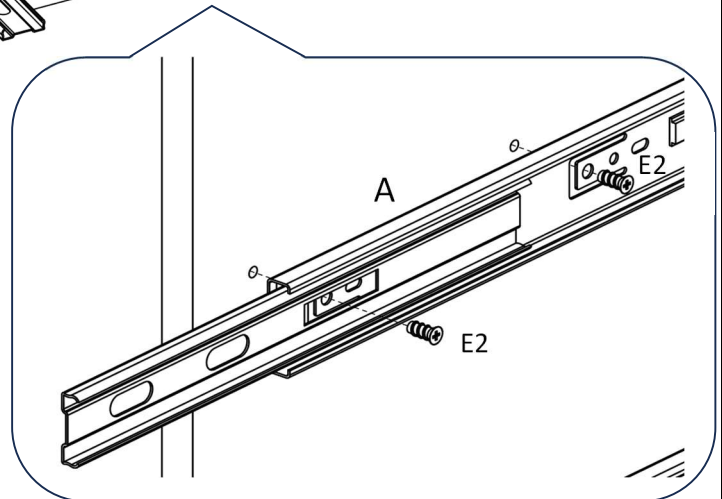
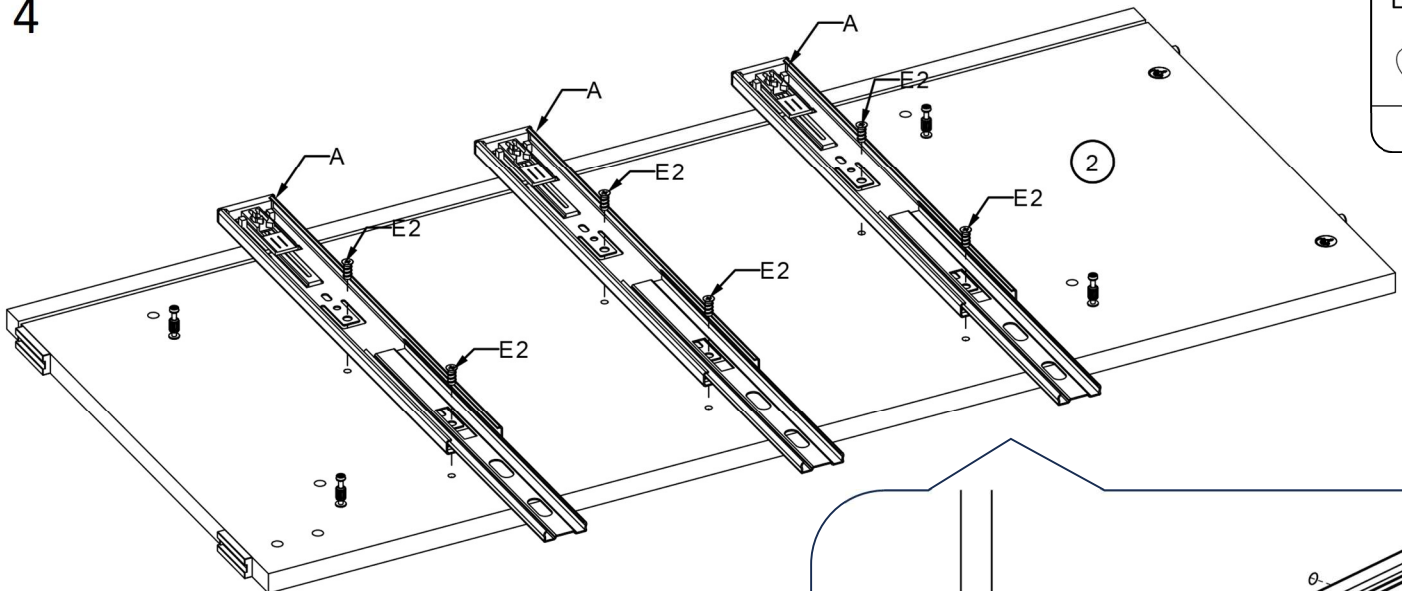
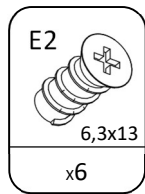

5

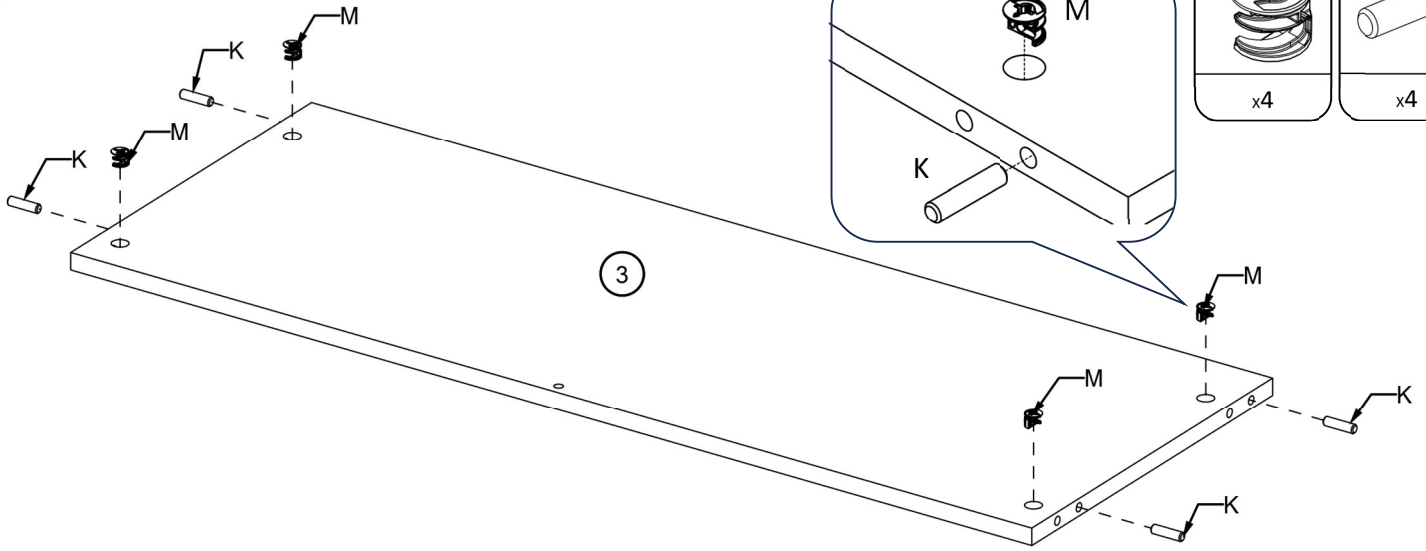

6

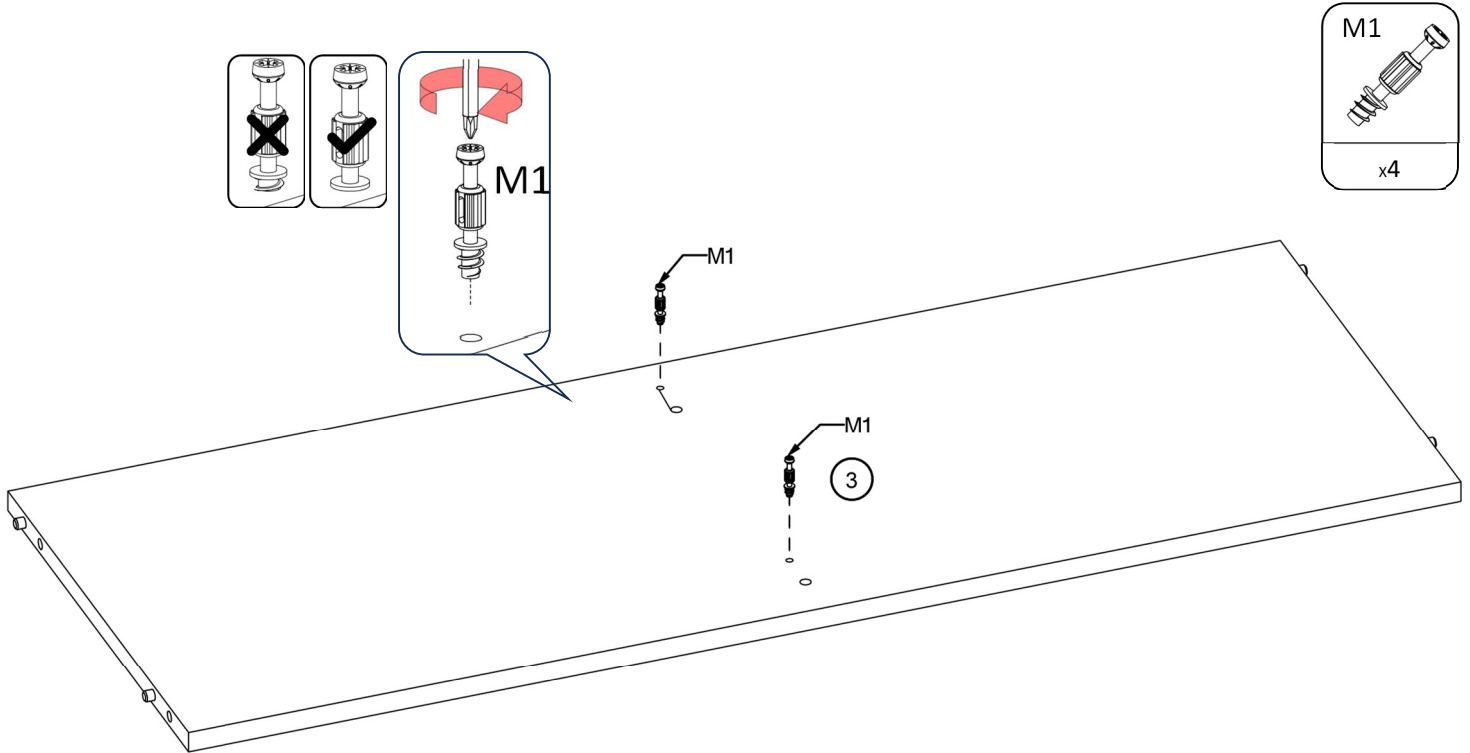

7

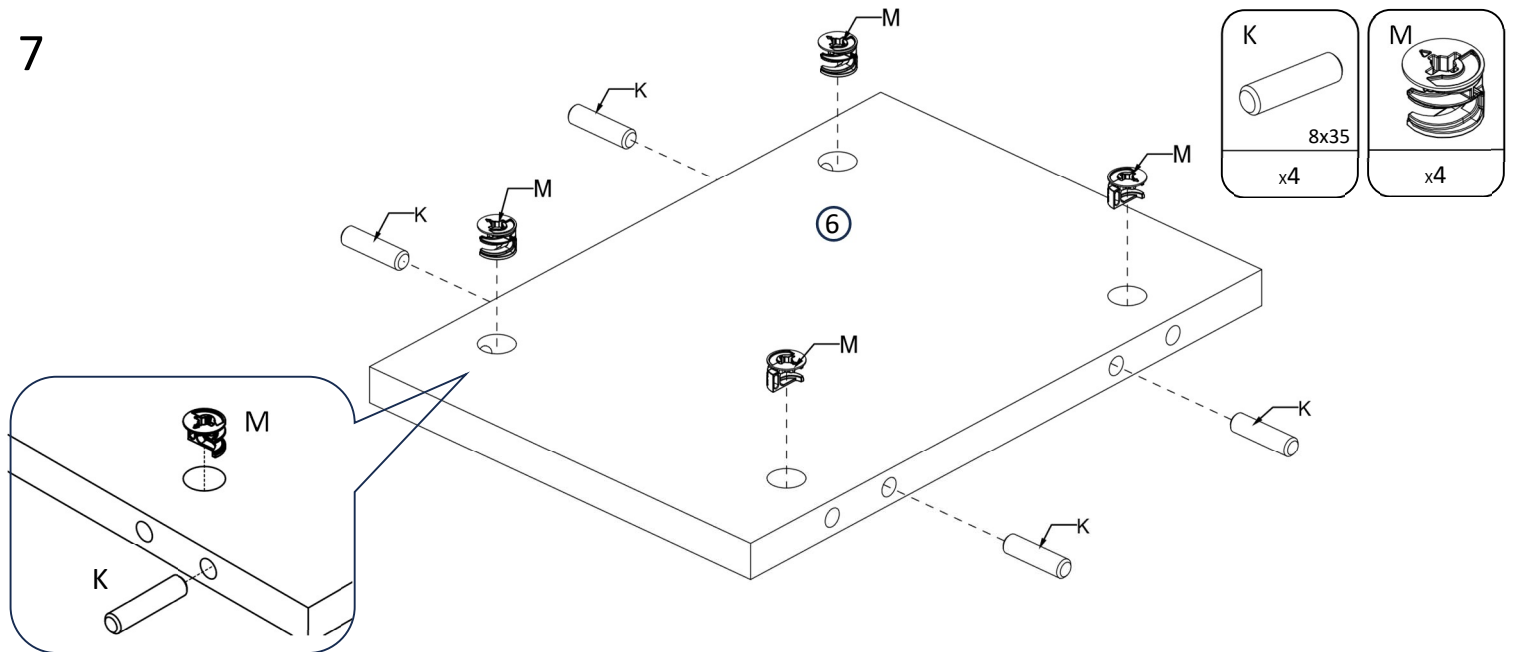

8

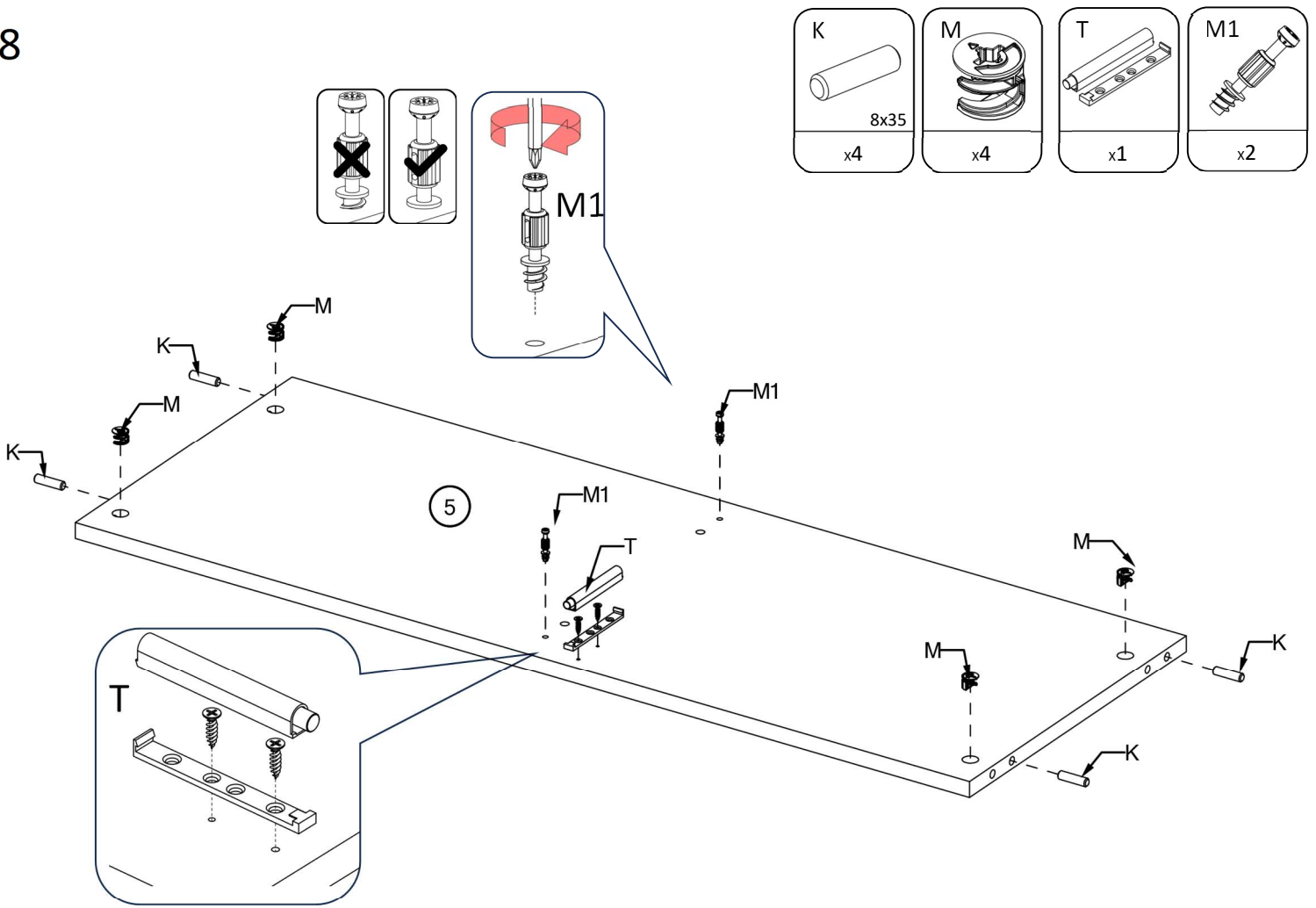

9

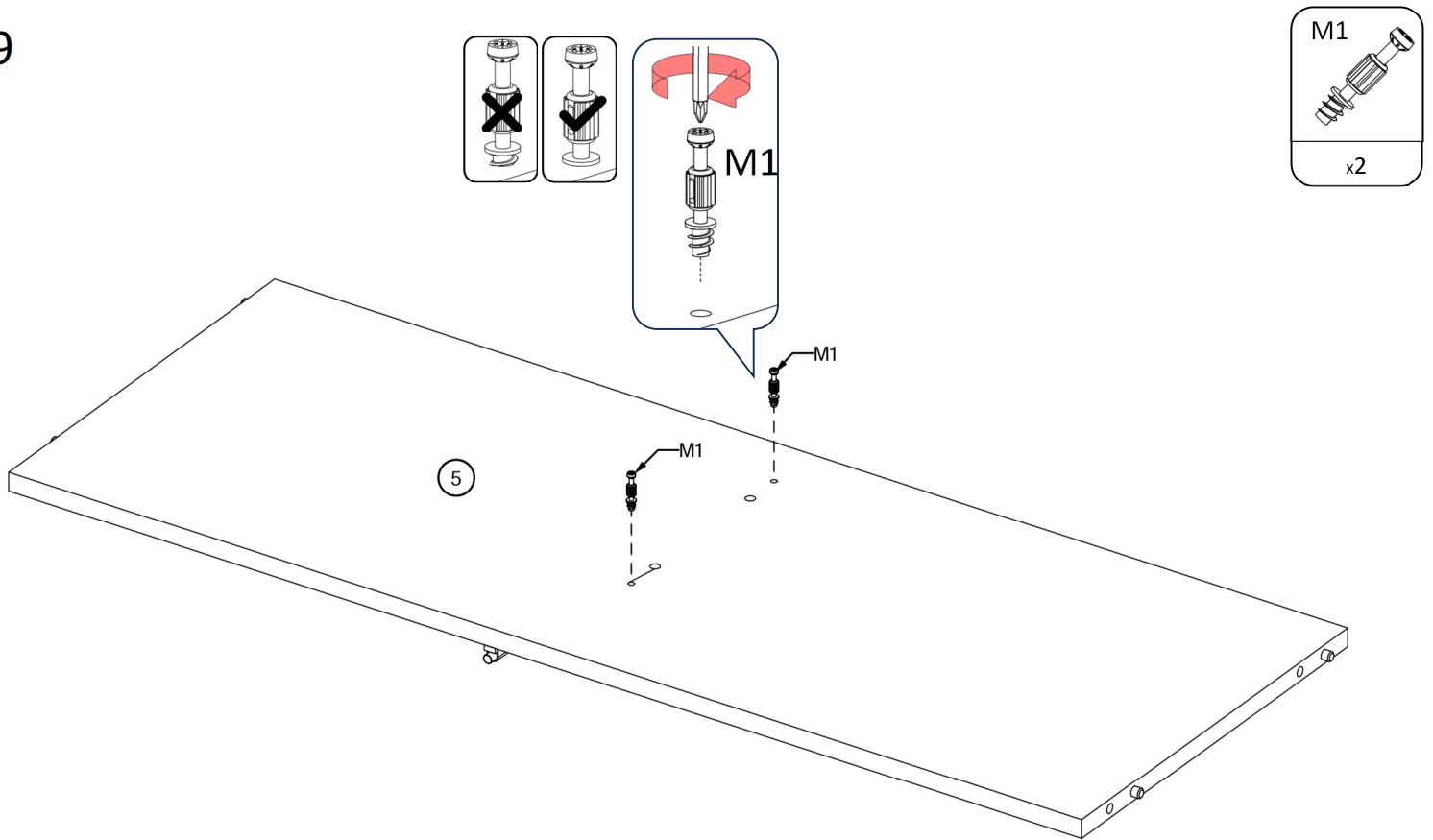

10

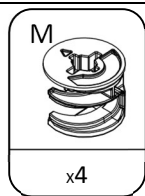
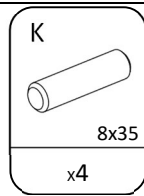
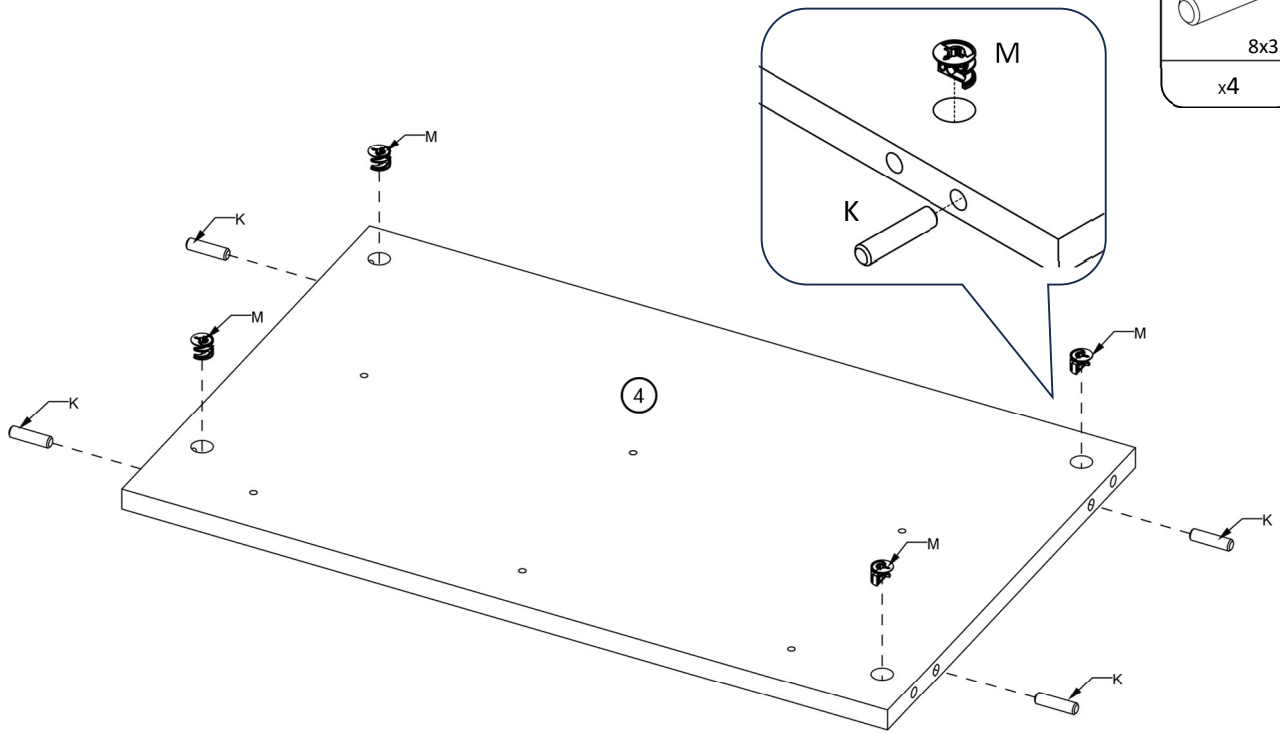

11

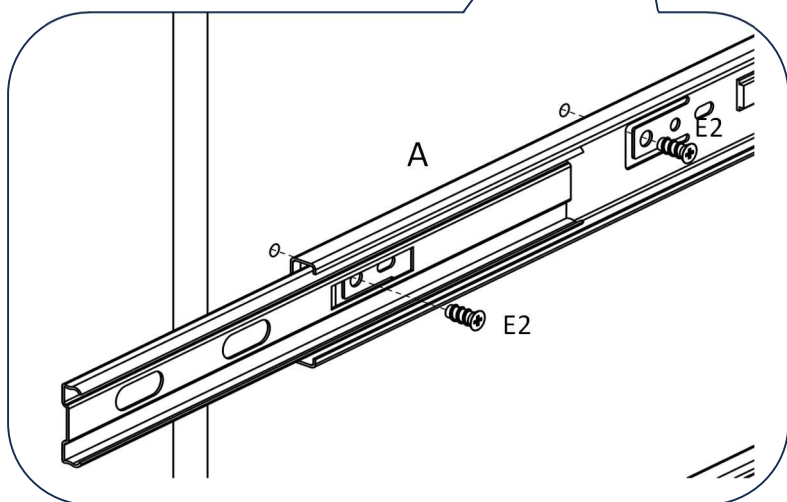
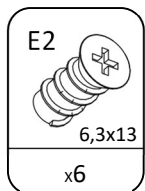
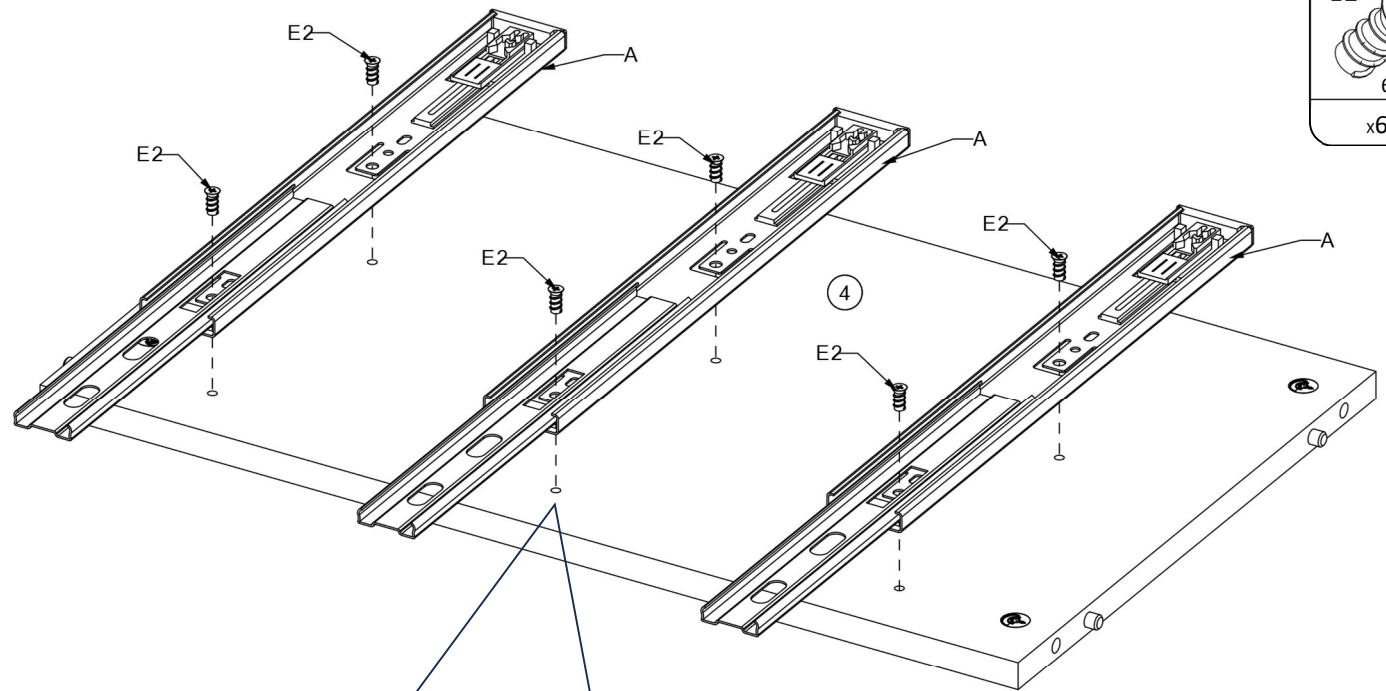

12

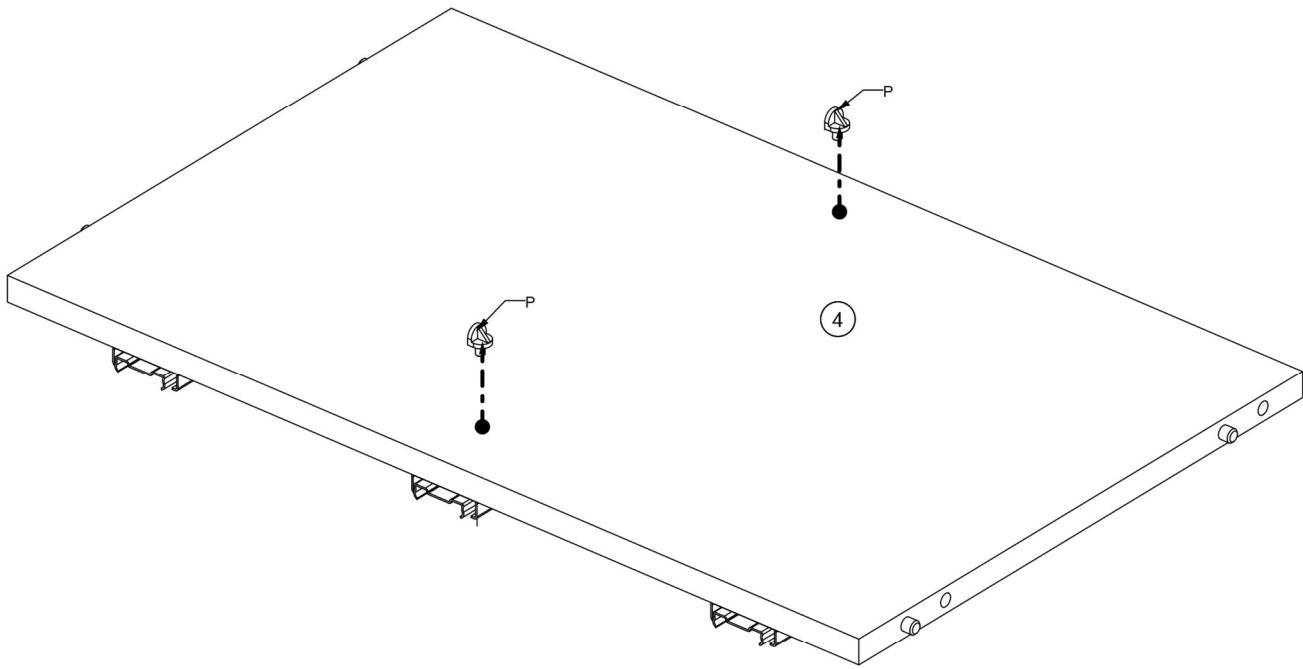
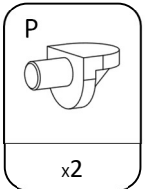

13

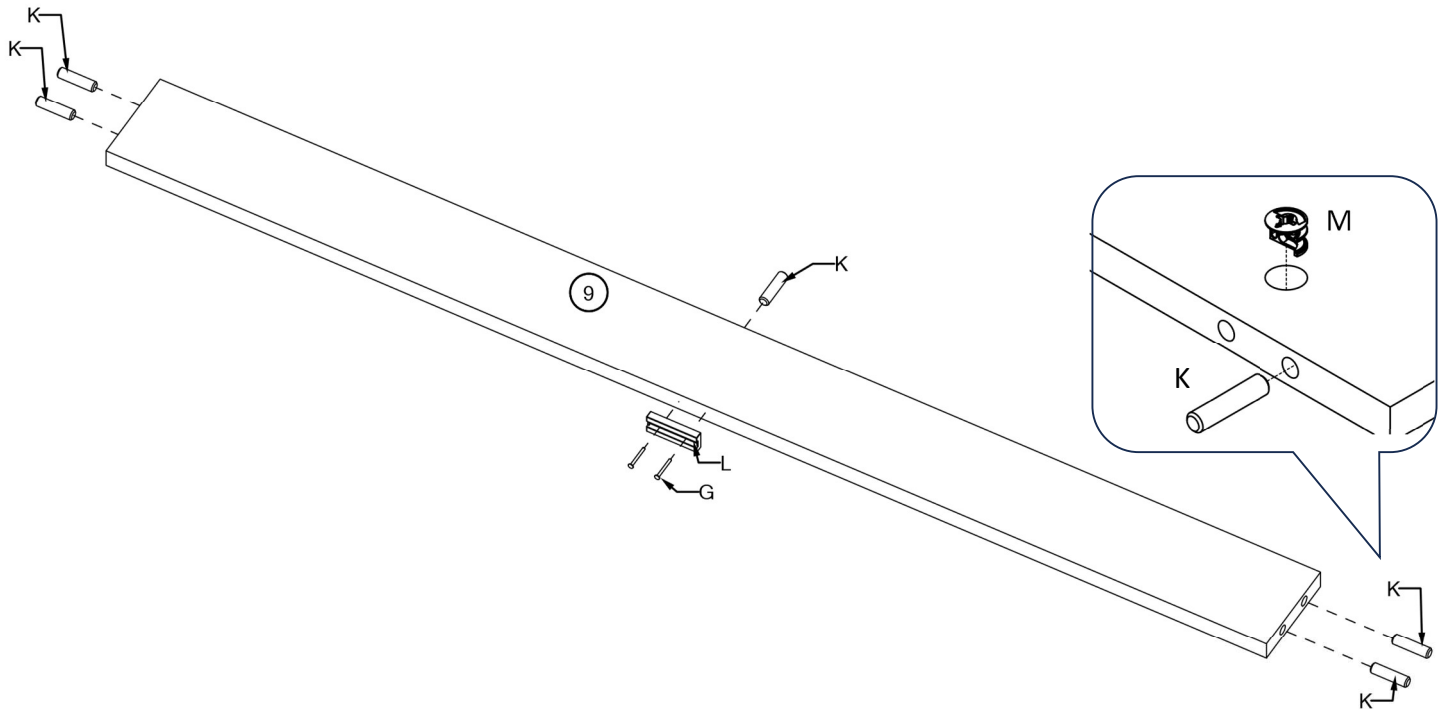
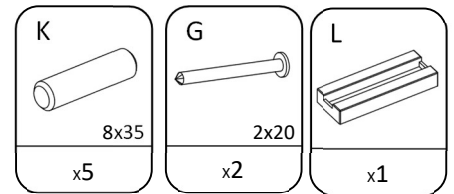

14

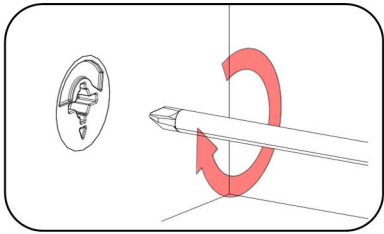
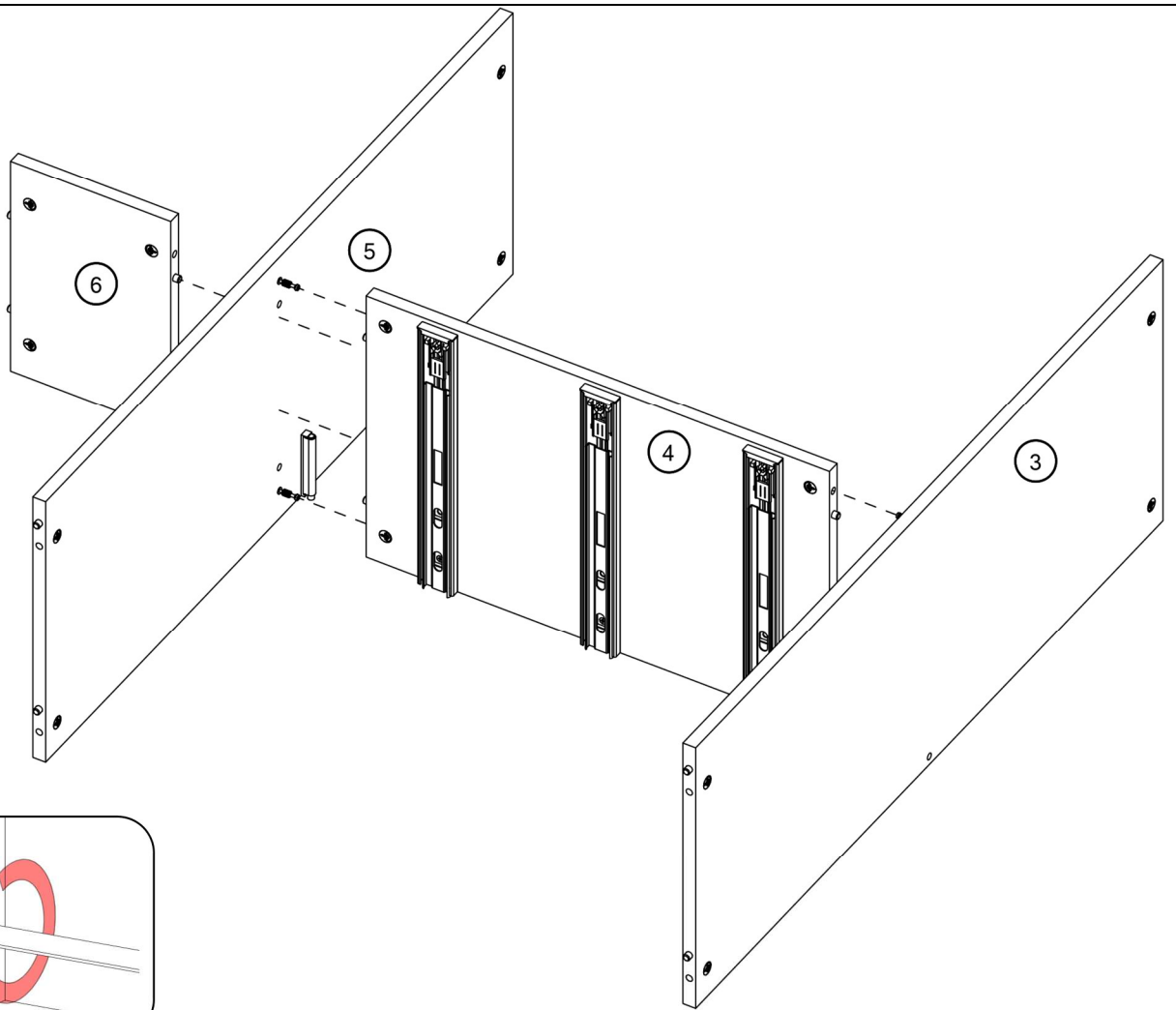

15

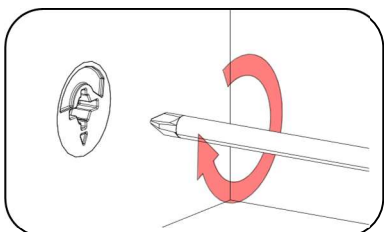
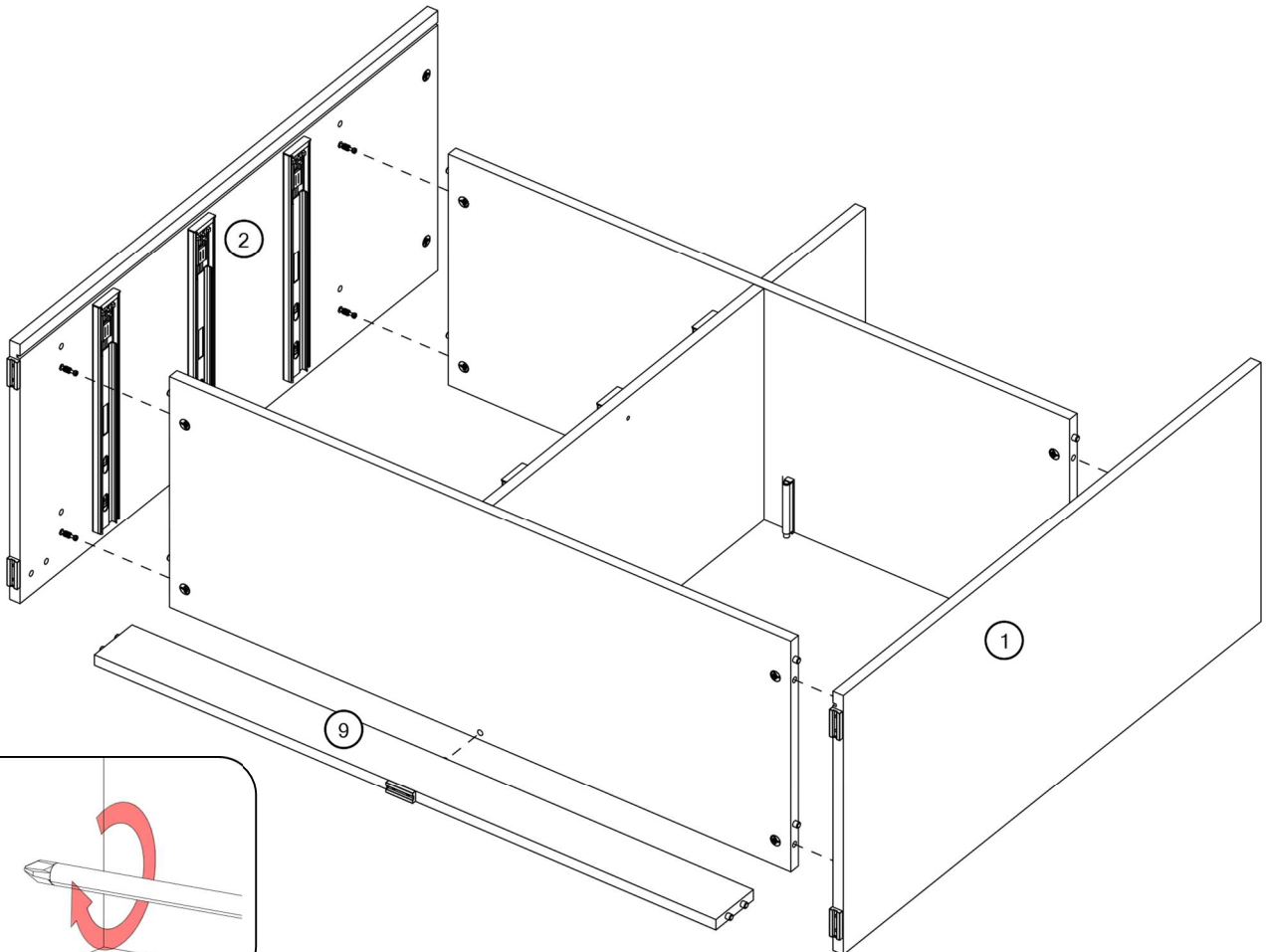

16

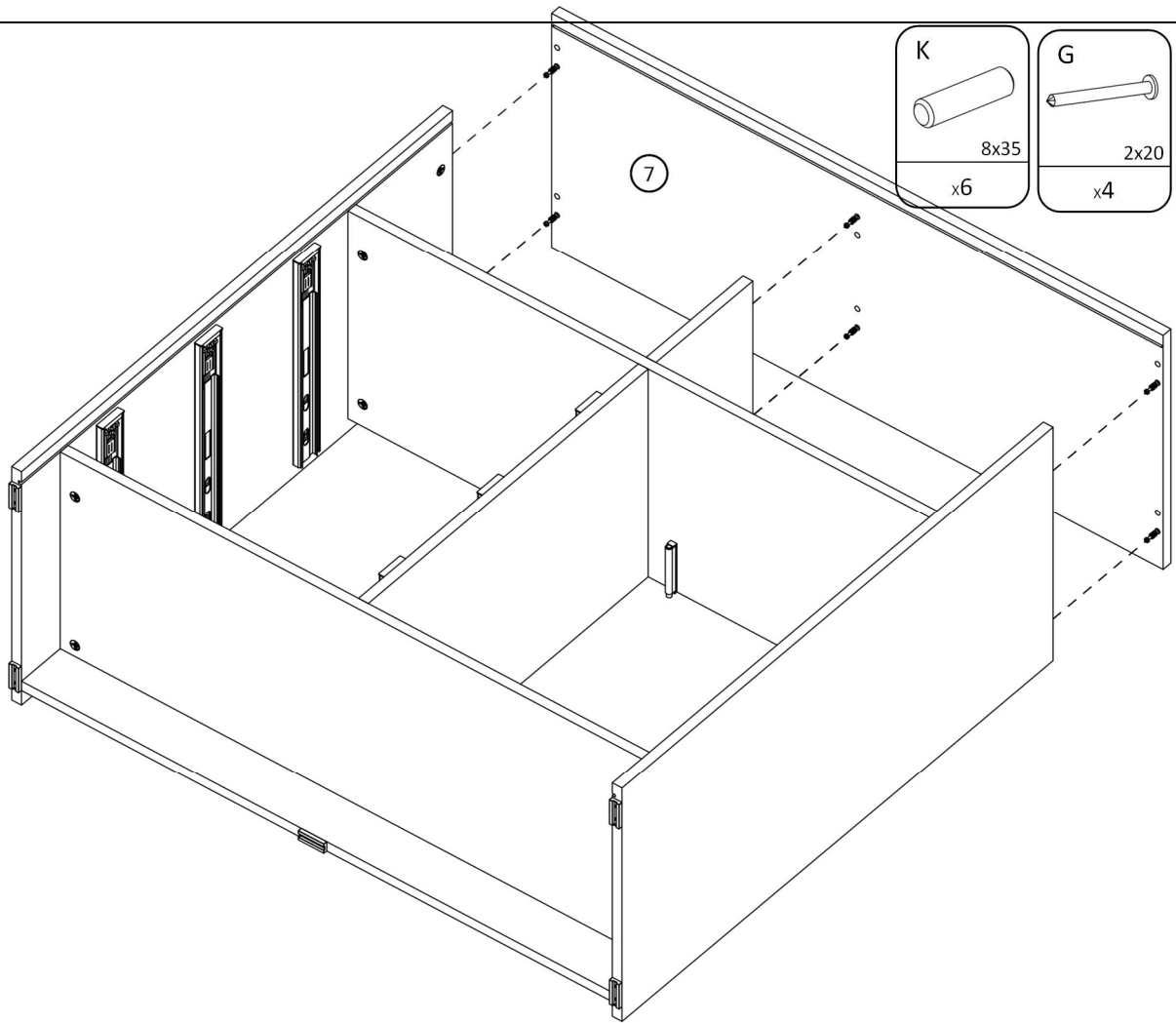

17

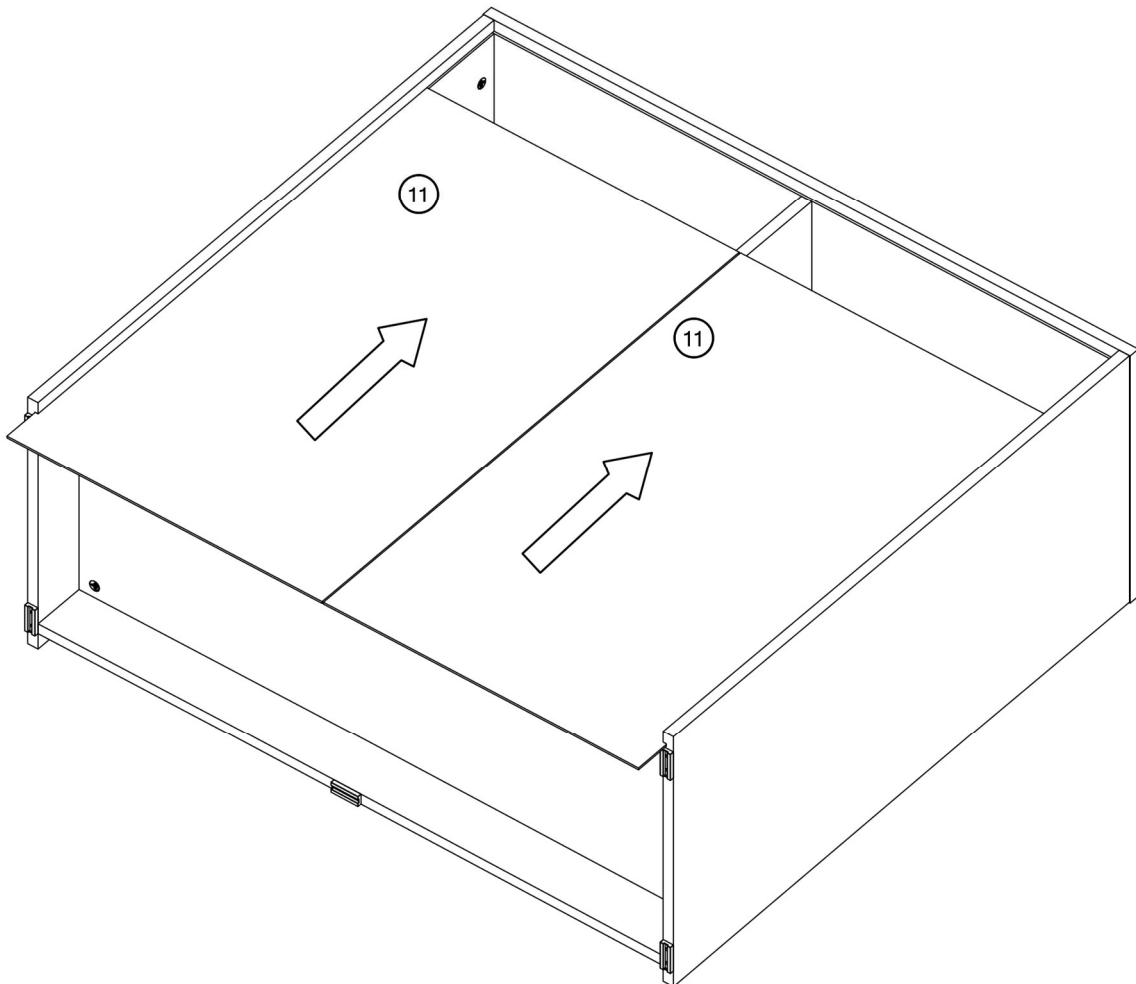

18

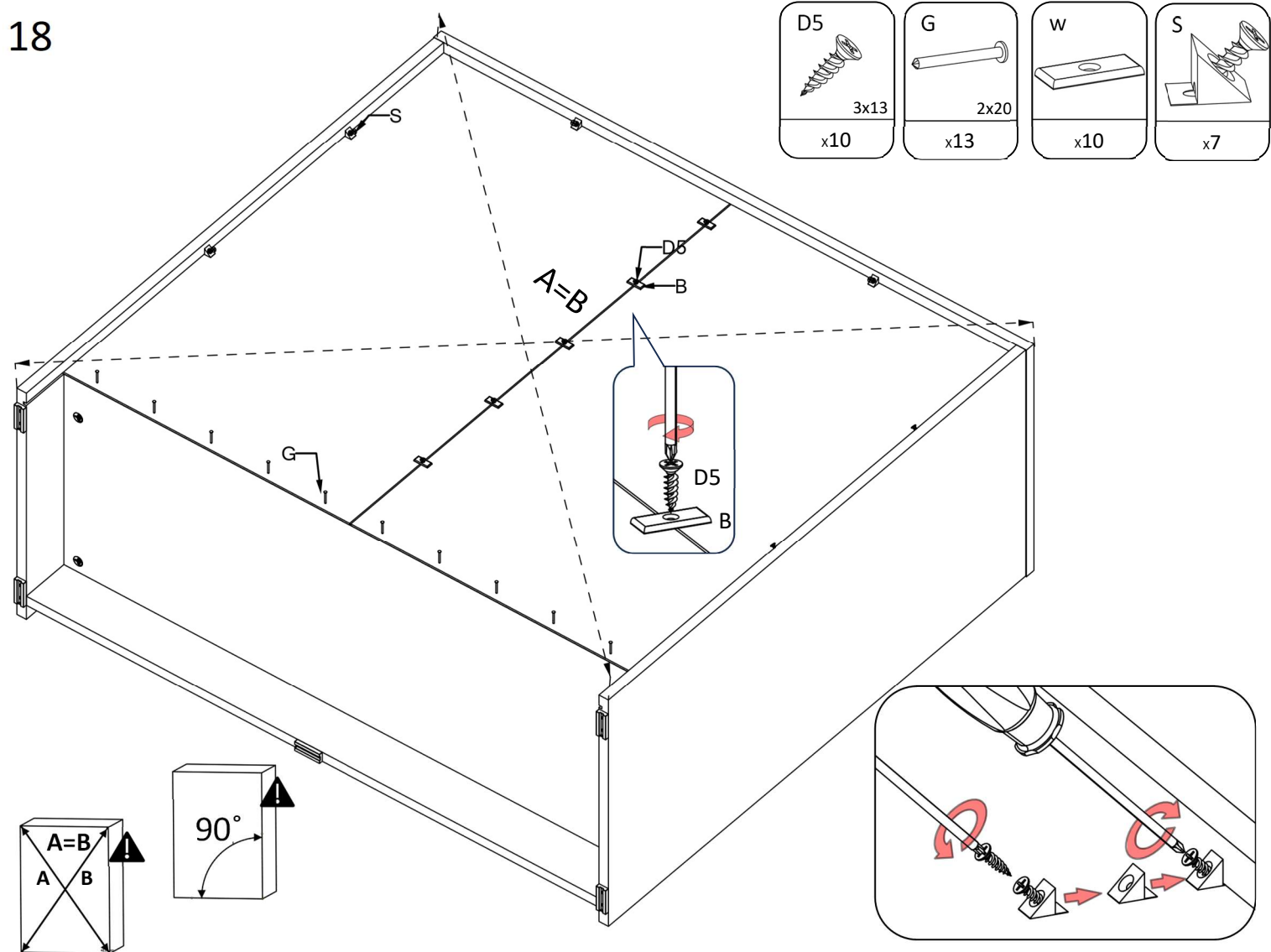

19

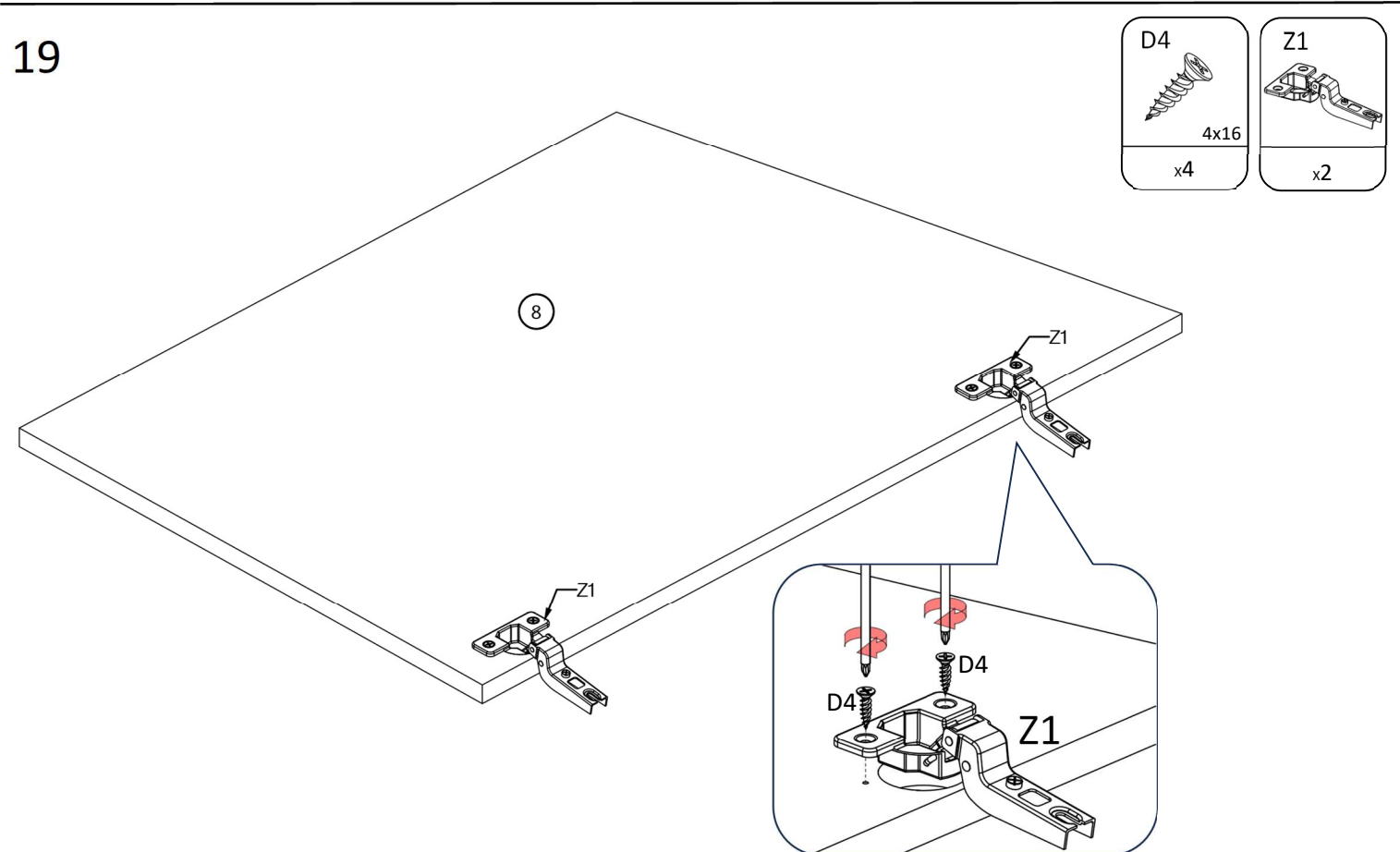

20

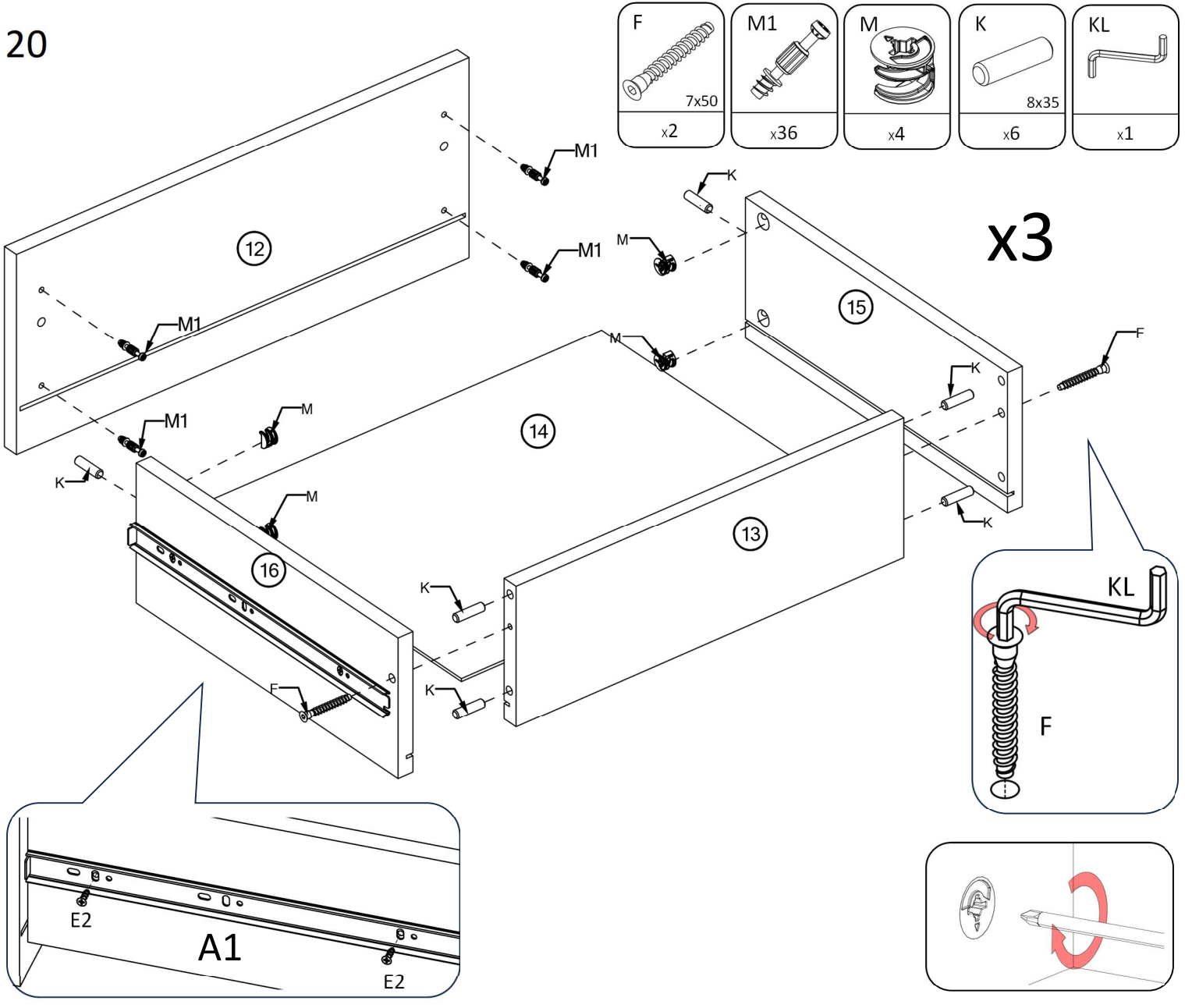

21

