

# ADEMO 1

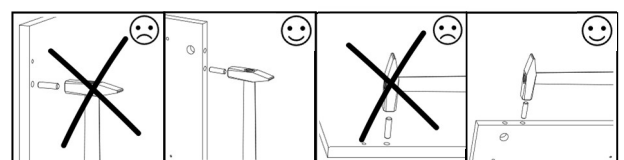

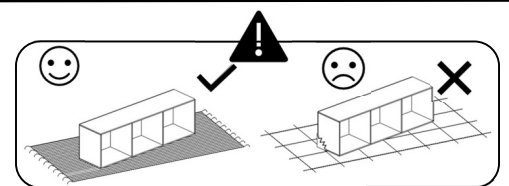

L

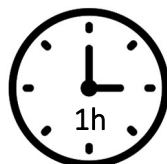
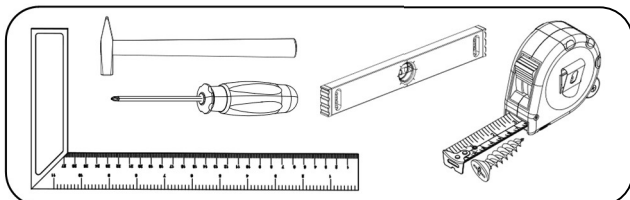
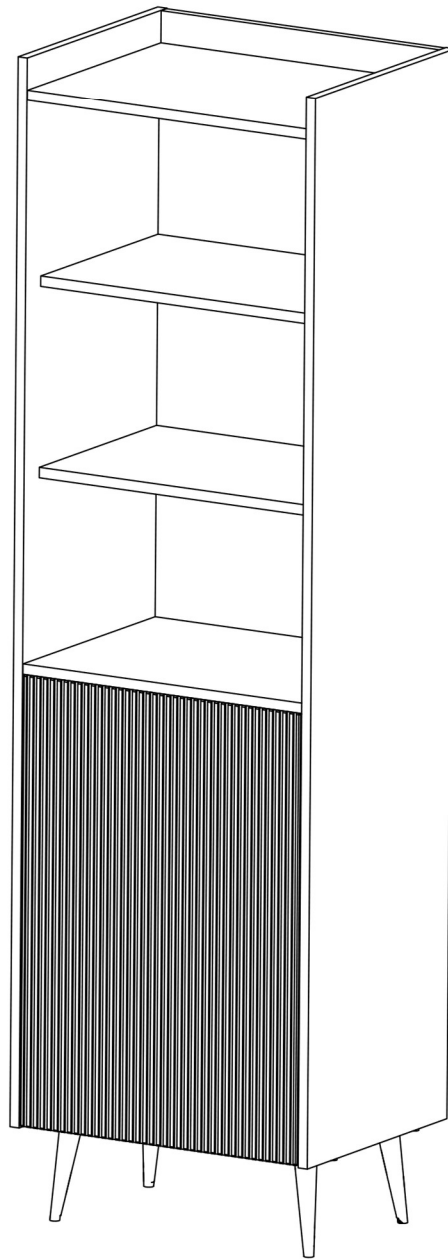
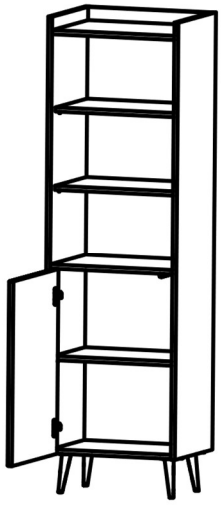
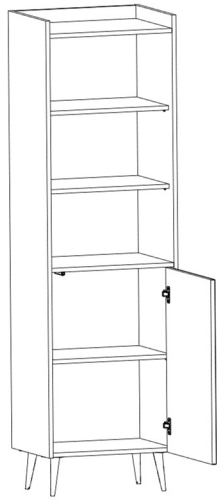

R

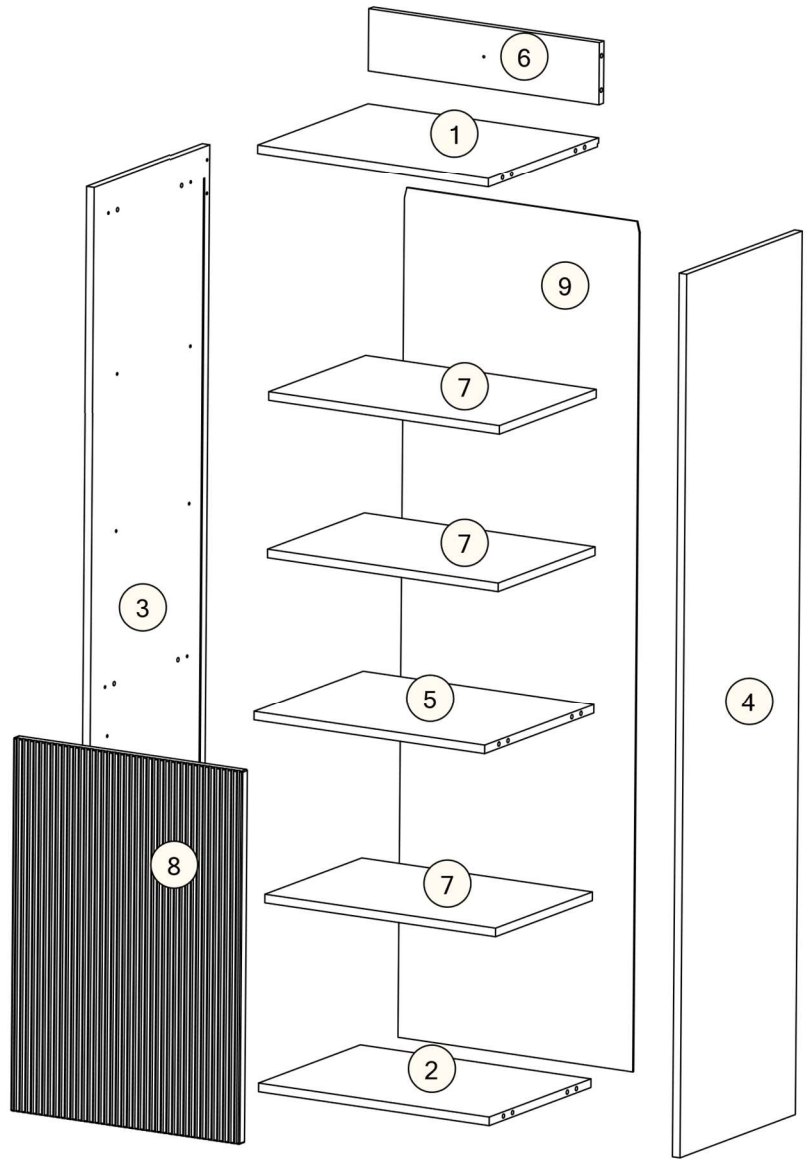

No	T(mm)	L(mm)	w(mm)	pcs.
1	16	490	387	1
2	16	490	357	1
3	16	1650	405	1
4	16	1650	405	1
5	16	490	383	1
6	16	490	116	1
7	16	490	340	3
8	18	696	486	1
9	3	1588	499	1

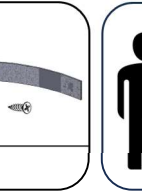
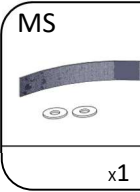
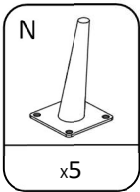
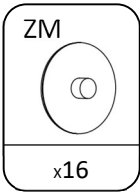
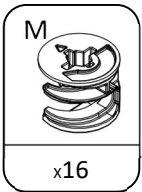
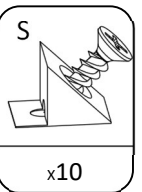
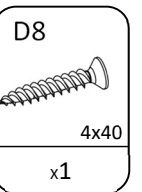
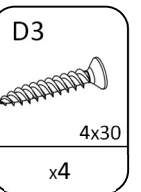
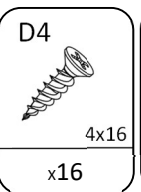
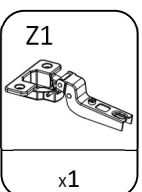
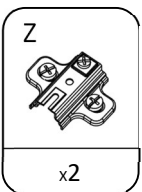
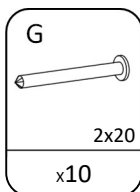
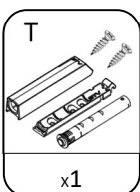
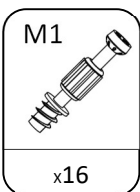
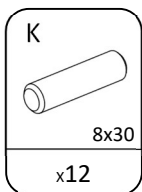
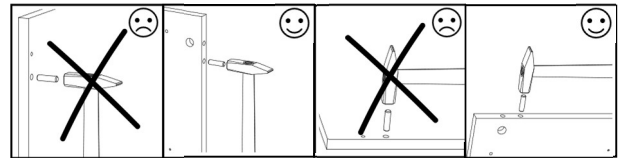
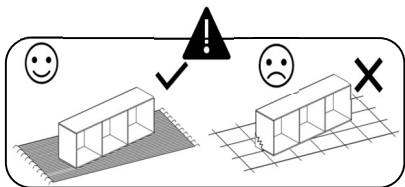

1

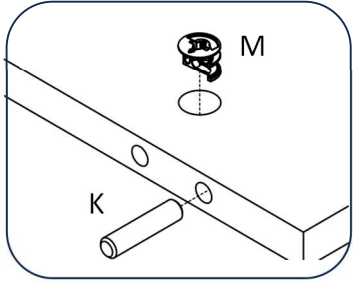
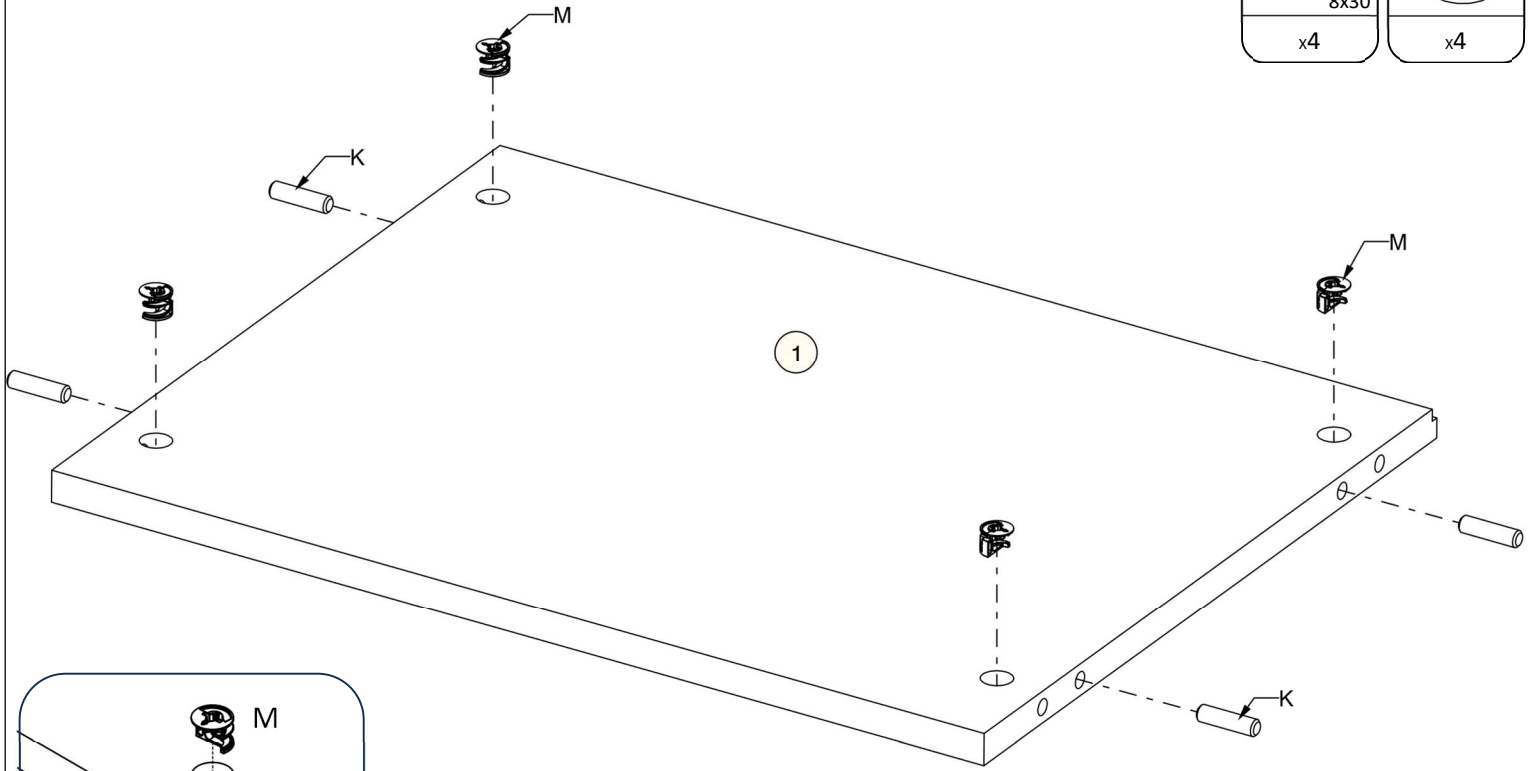
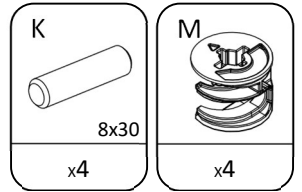

2

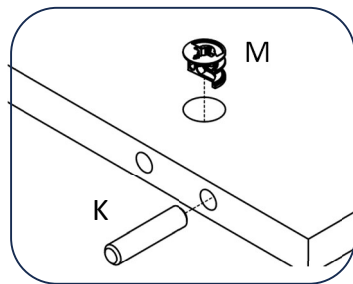
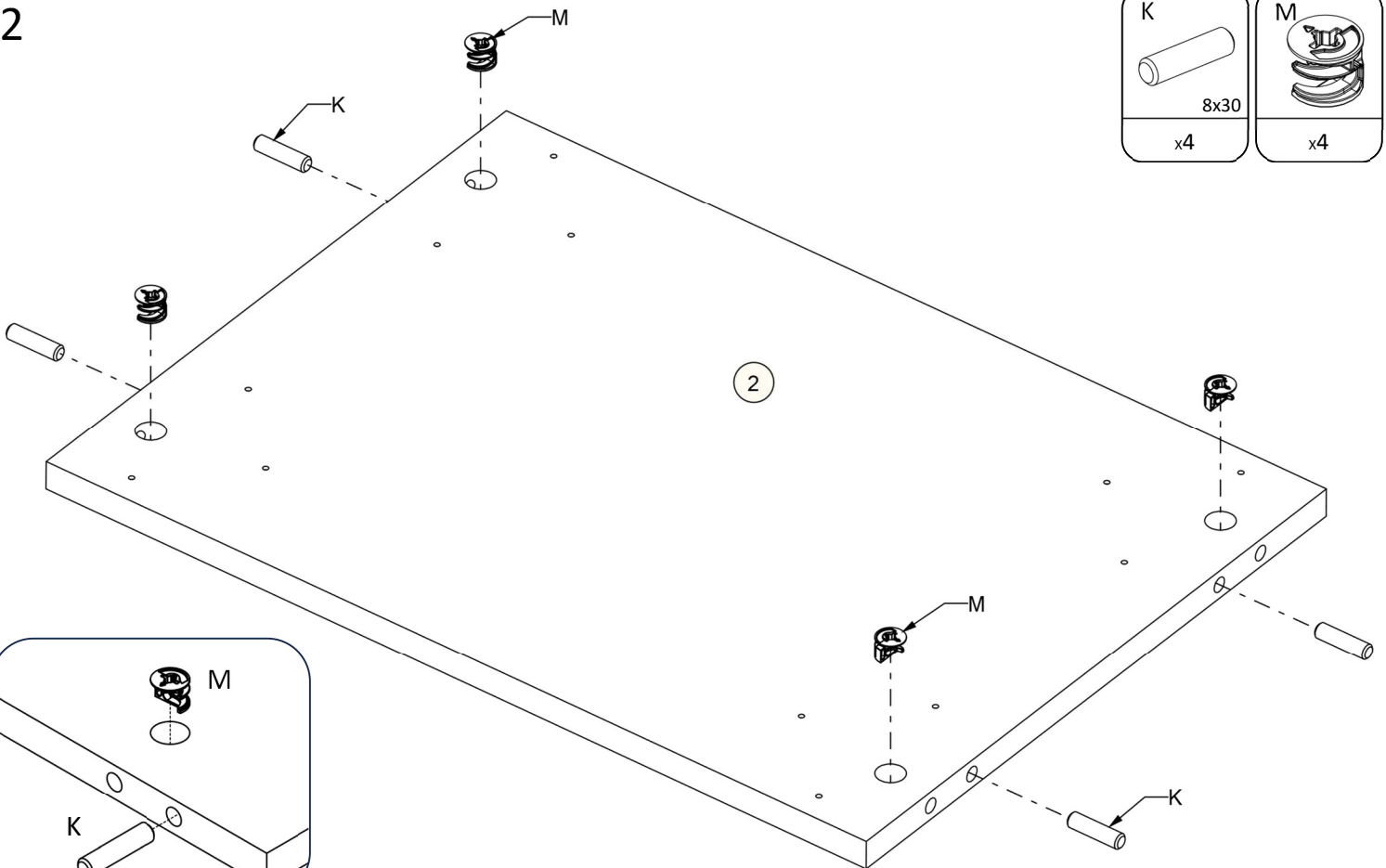
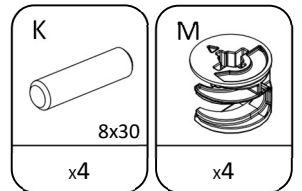

3

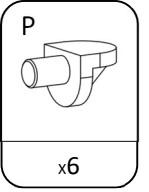
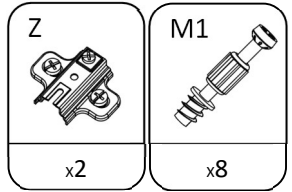
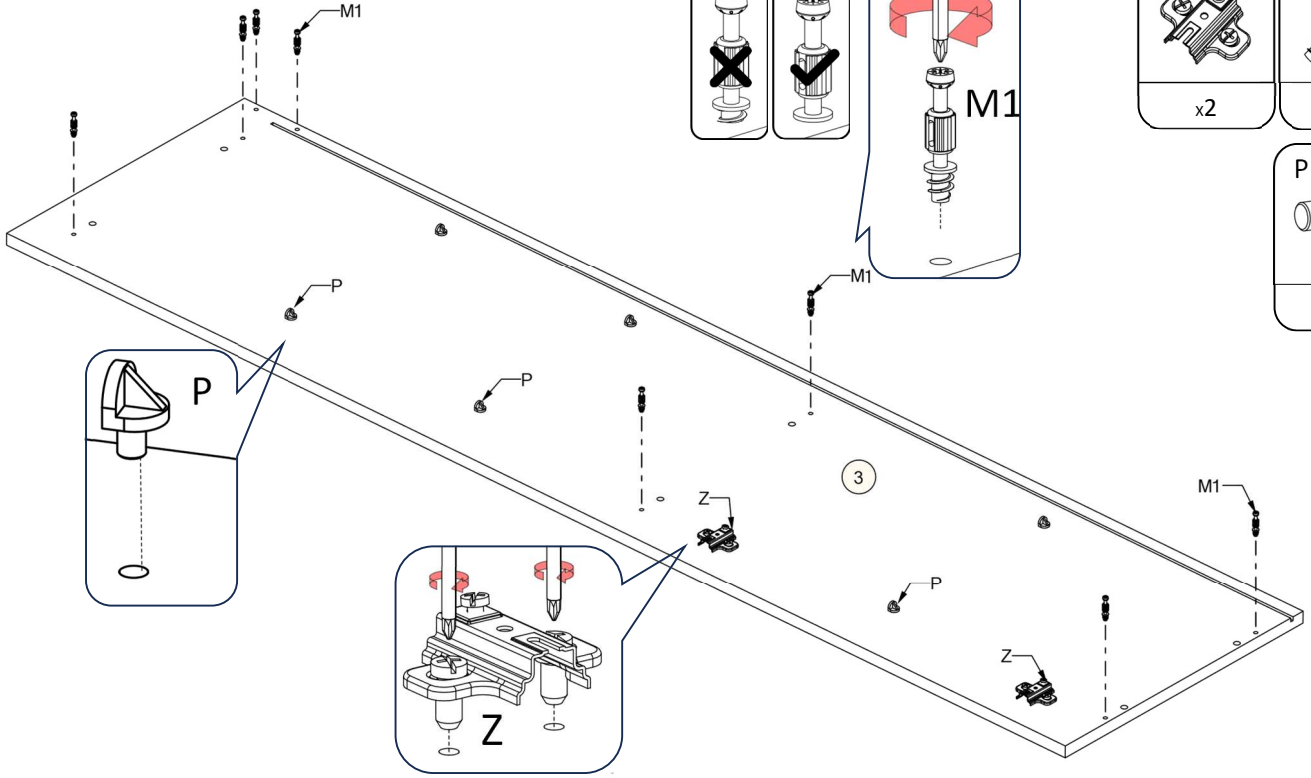

4

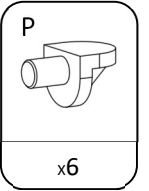
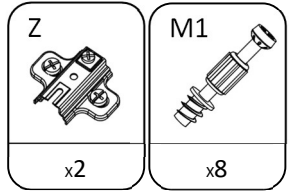
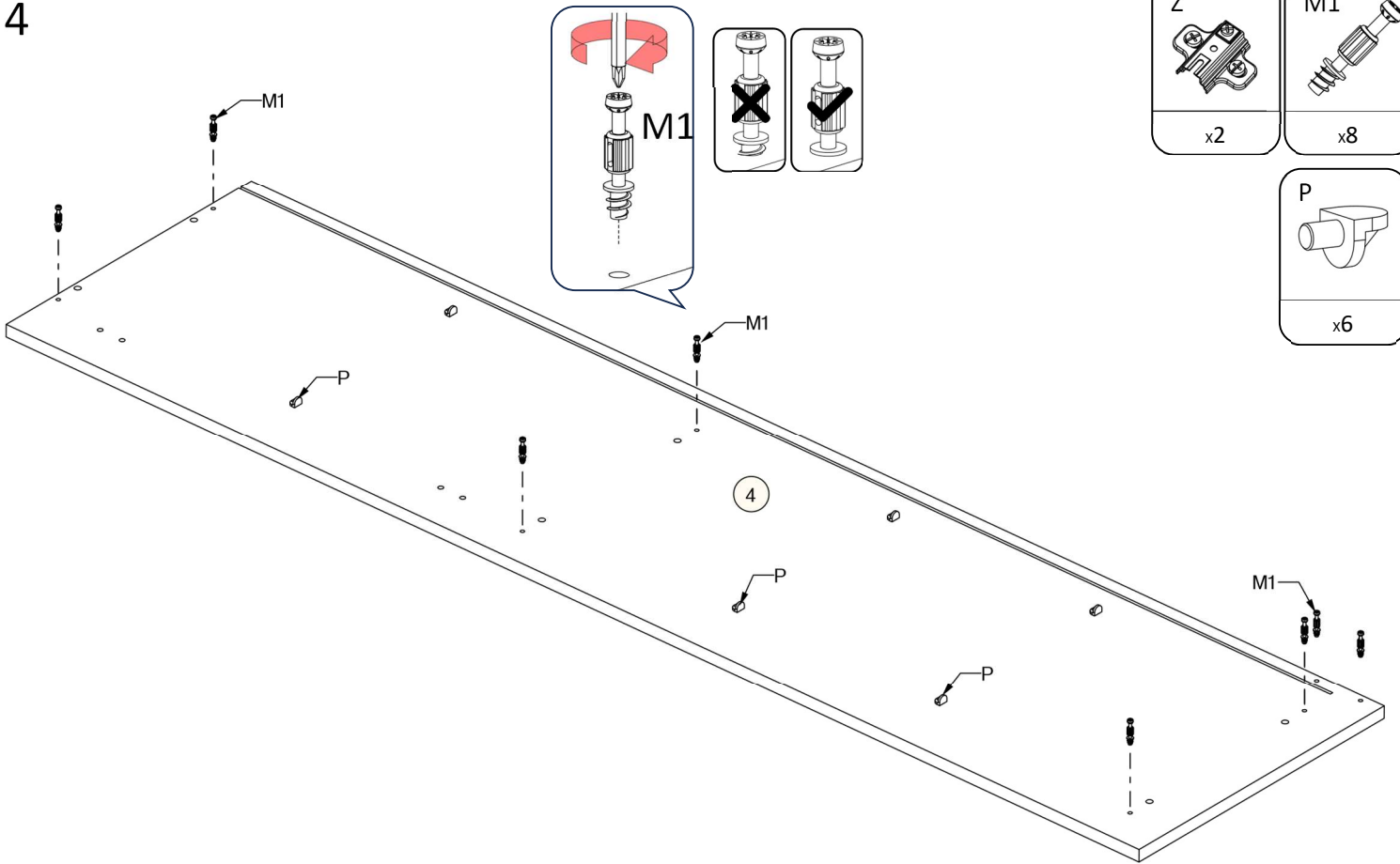

5

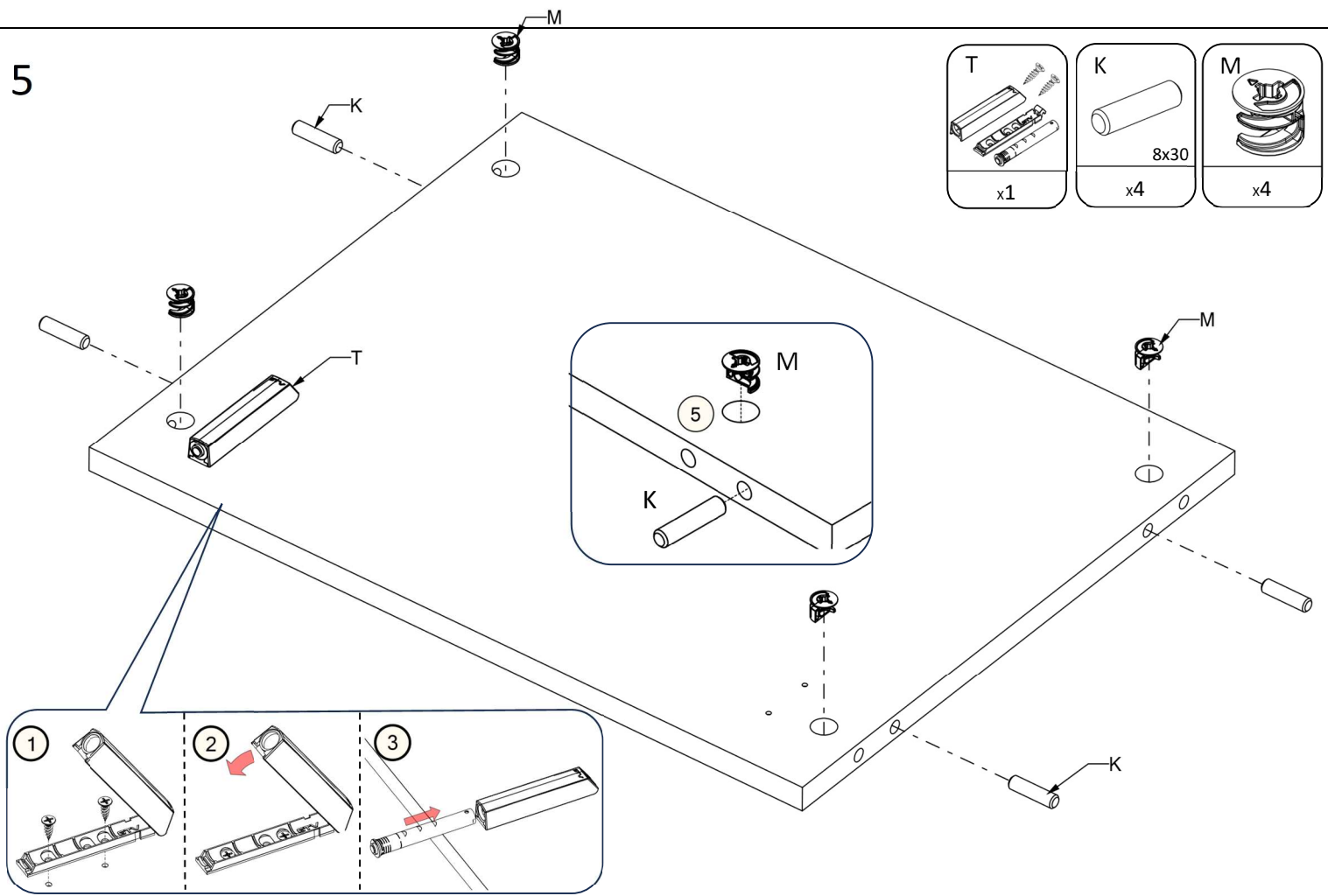

6

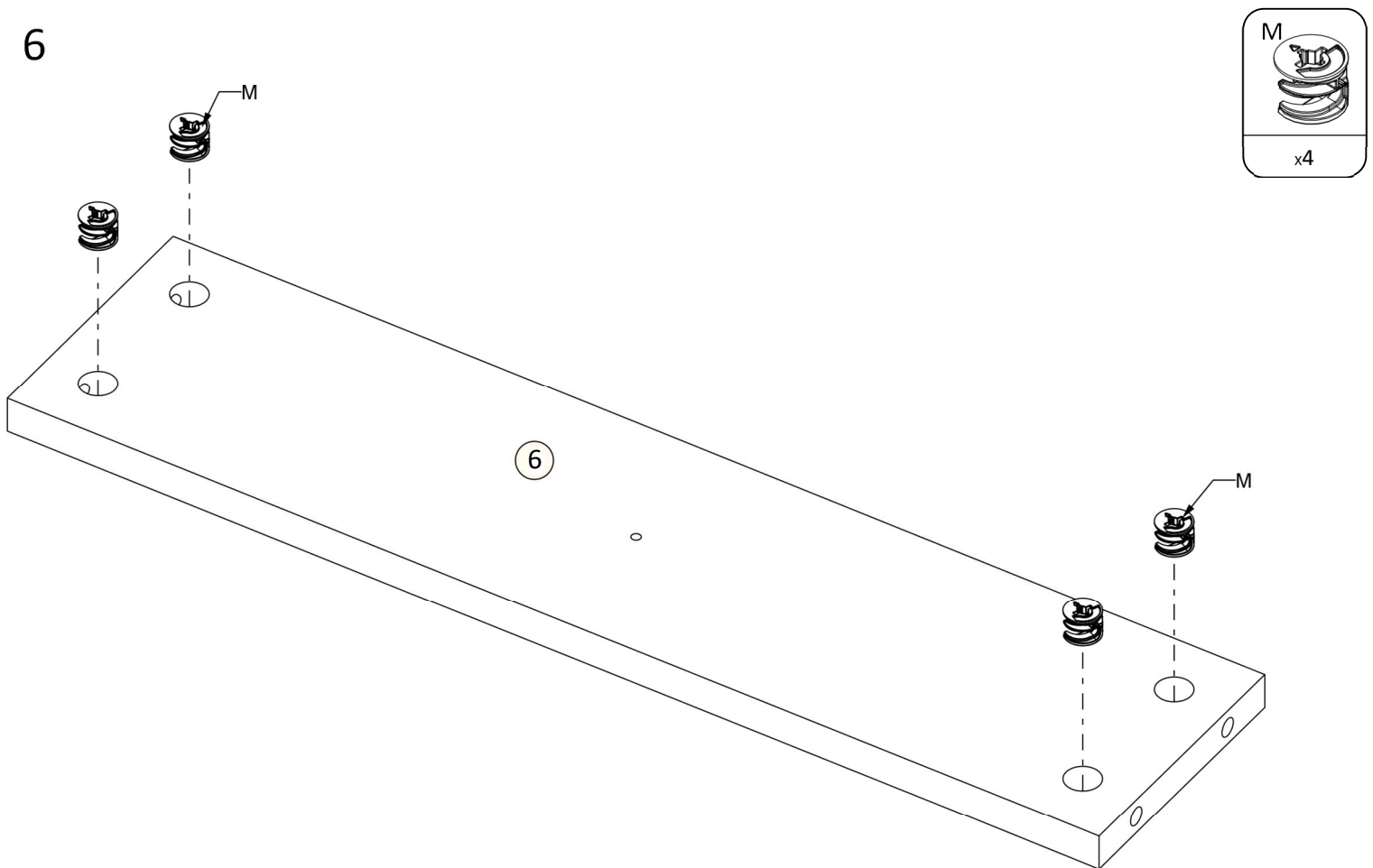

7

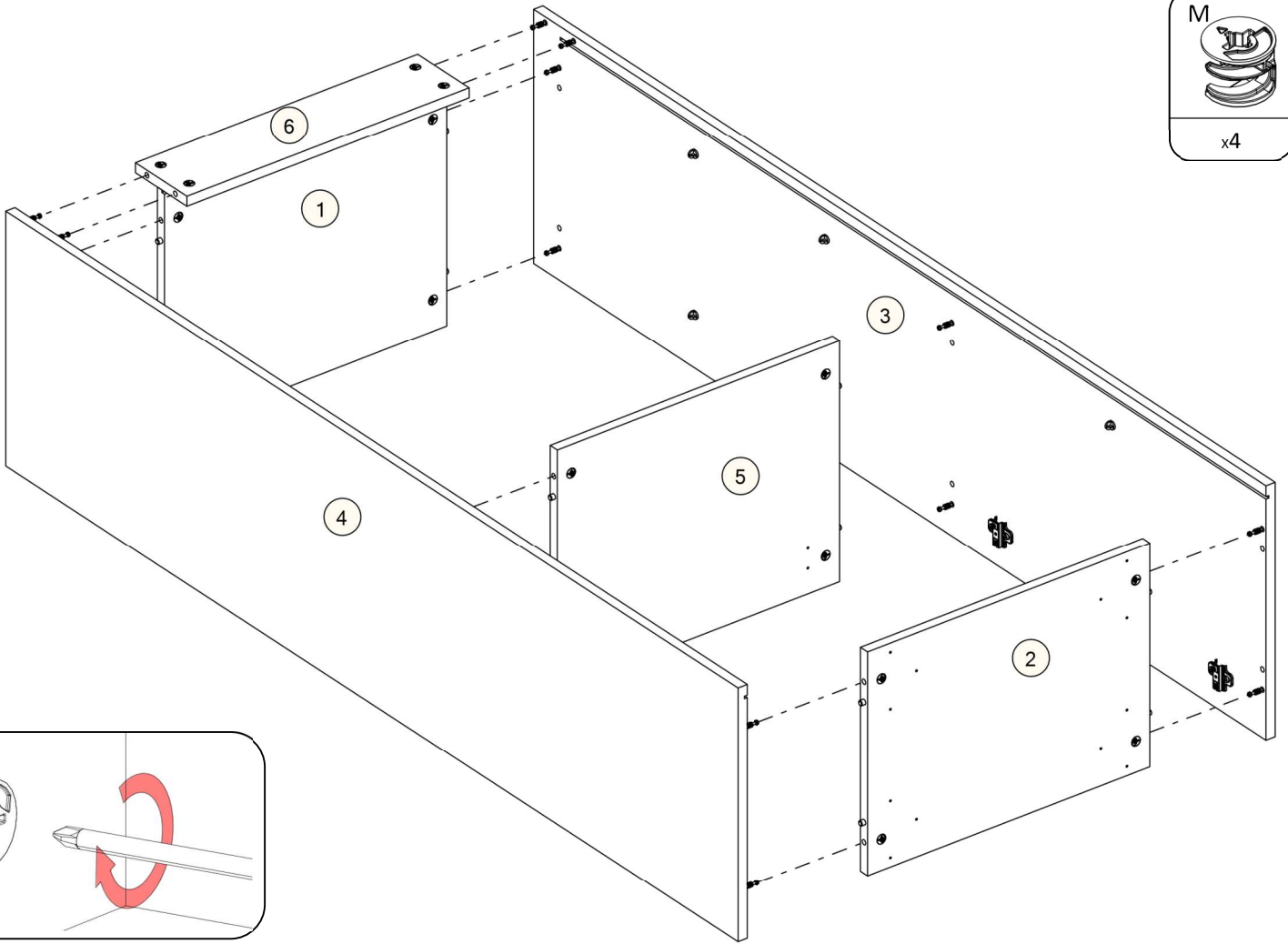
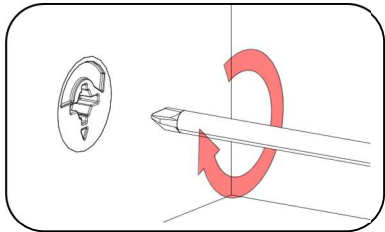
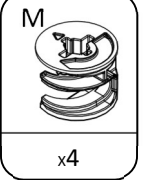

8

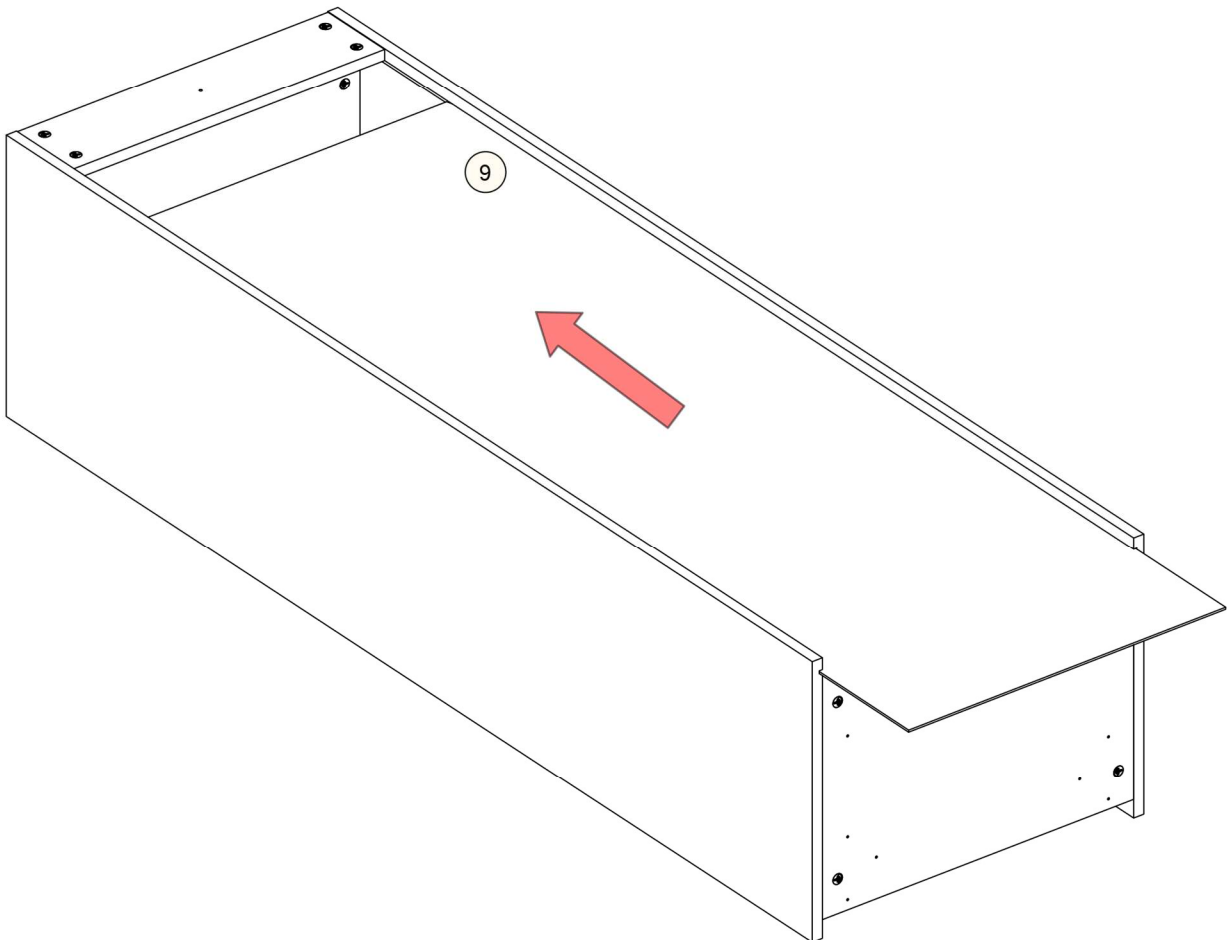

9

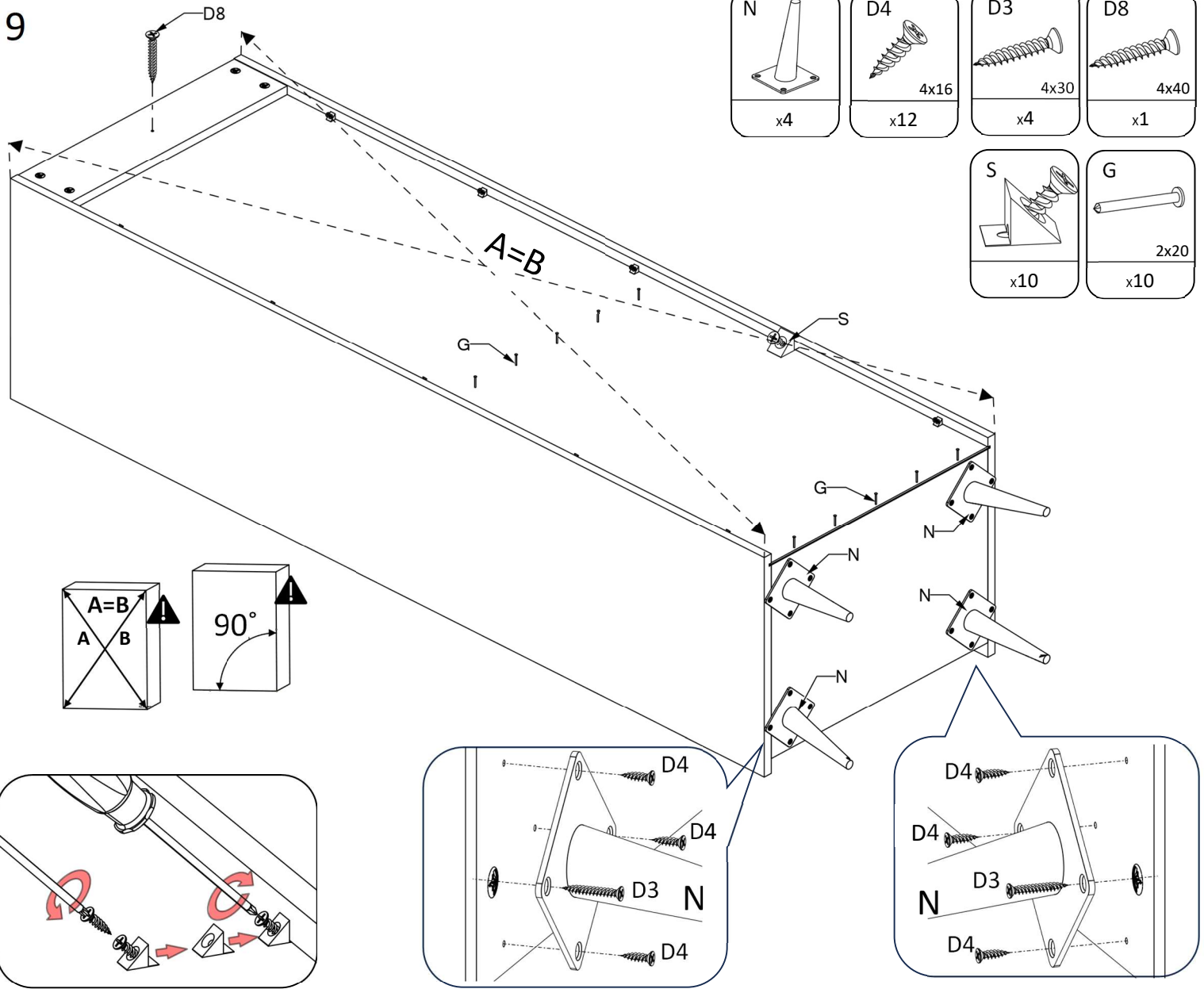

10

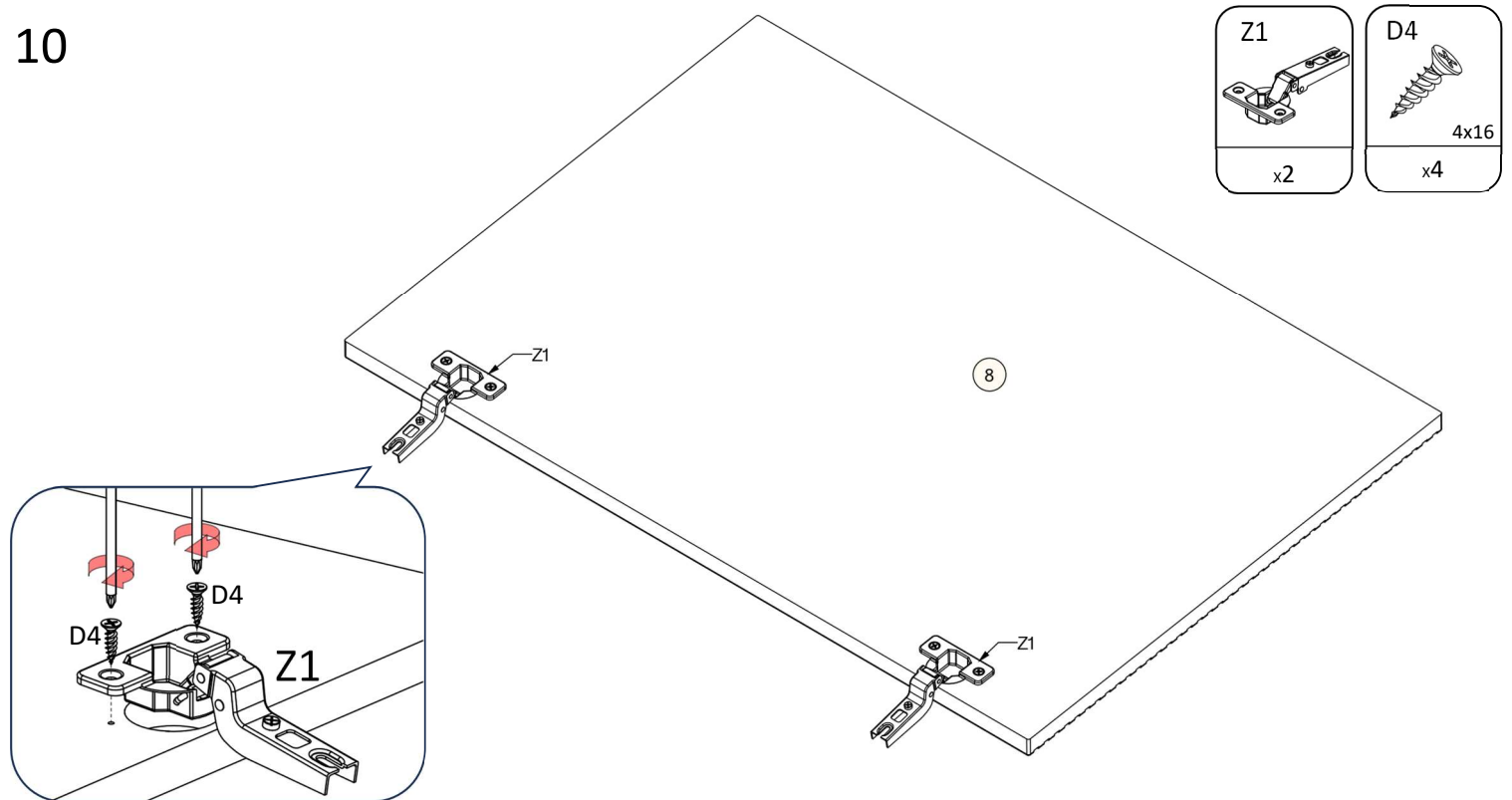

11

