

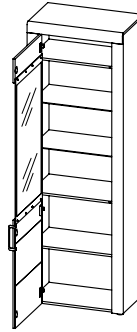

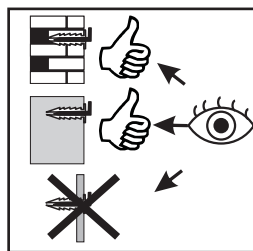

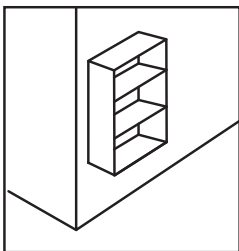

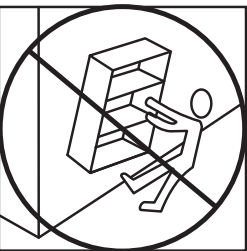

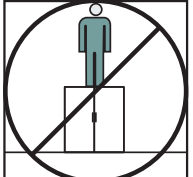
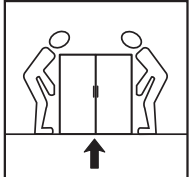
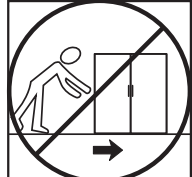
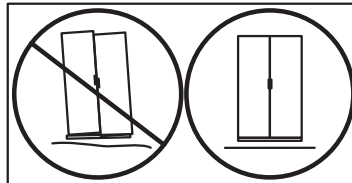
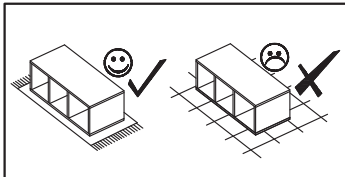
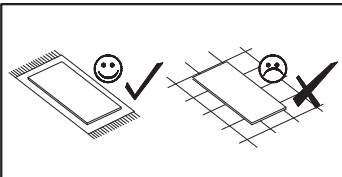
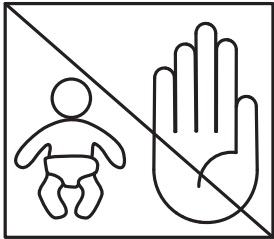
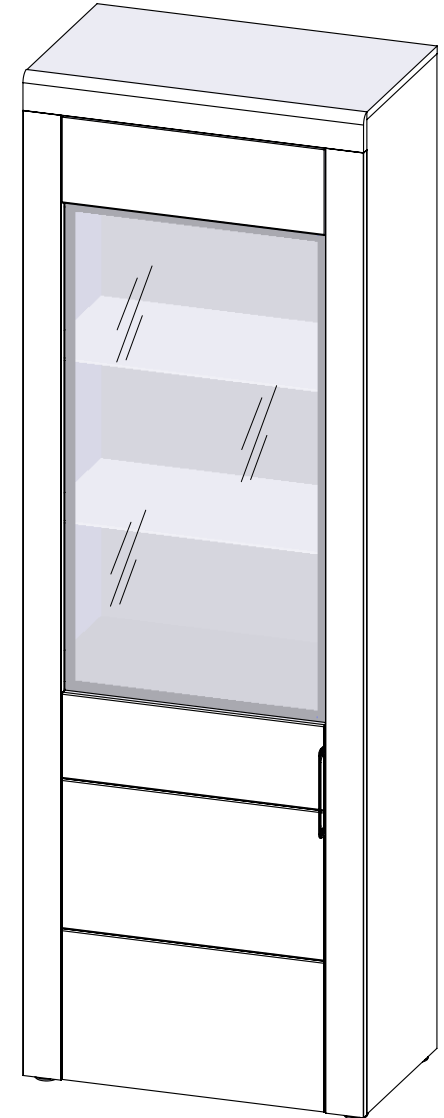
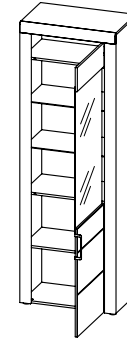







L





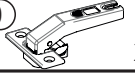

P





- (B1)**  ϕ 8x28 x20
- (T1)**  x28
- (M1)**  x28
- (C2)**  ϕ 20 x24
- (C13)**  ϕ 35 x3
- (W1)**  x4
- (W2)**  x8
- (F1)**  x5
- (J23)**  x12
- (P2)**  3x16 x18
- (G4)**  x8
- (L6)**  x2

- (X9)**  x3
- (X19)**  x1
- (S8)**  4x13 x6
- (D4)**  x3

- (F10)**  x4
- (P17)**  4x20 x4

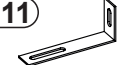
- (U35)**  x1
- (P2)**  3x16 x2

- (J11)**  x1
- (P13)**  3,5x13 x2



Nr	Ausmaß		St	Colli	
1	638	340	5	2	1
2	1024	516	4	1	2
3	1901	75	18	1	2
4	1901	75	18	1	2
5	671	75	18	1	1
6	1960	382	15	1	2
7	1960	382	15	1	2
8	762	516	15	1	2
9	516	170	15	1	2
12	639	357	15	2	1
13	639	357	15	1	1
14	639	382	15	1	1
15	670	382	15	1	1
16	762	653	2	1	2
17	653	1196	2	1	2

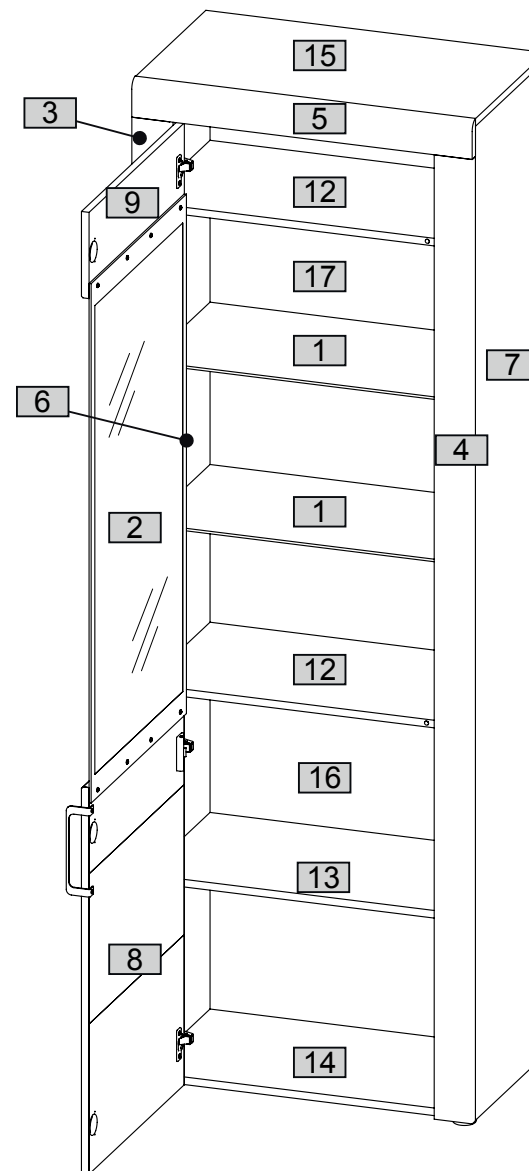

0 10 20 30 40 50 60 70 80 90 100 110 120 130 140 150 160 170 180 190 200



1

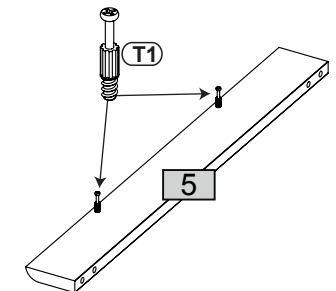
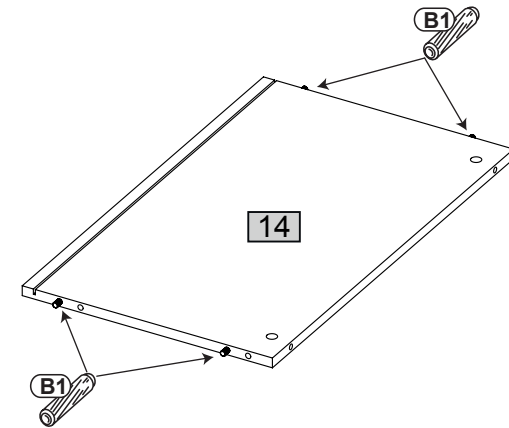
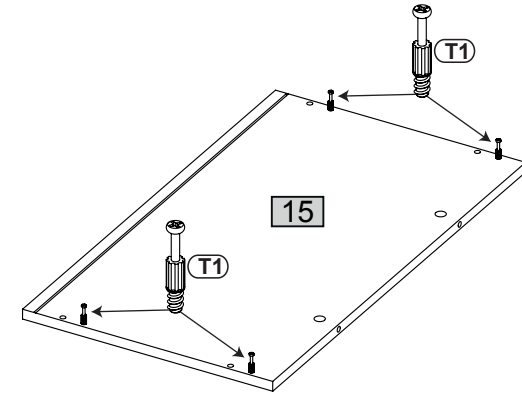
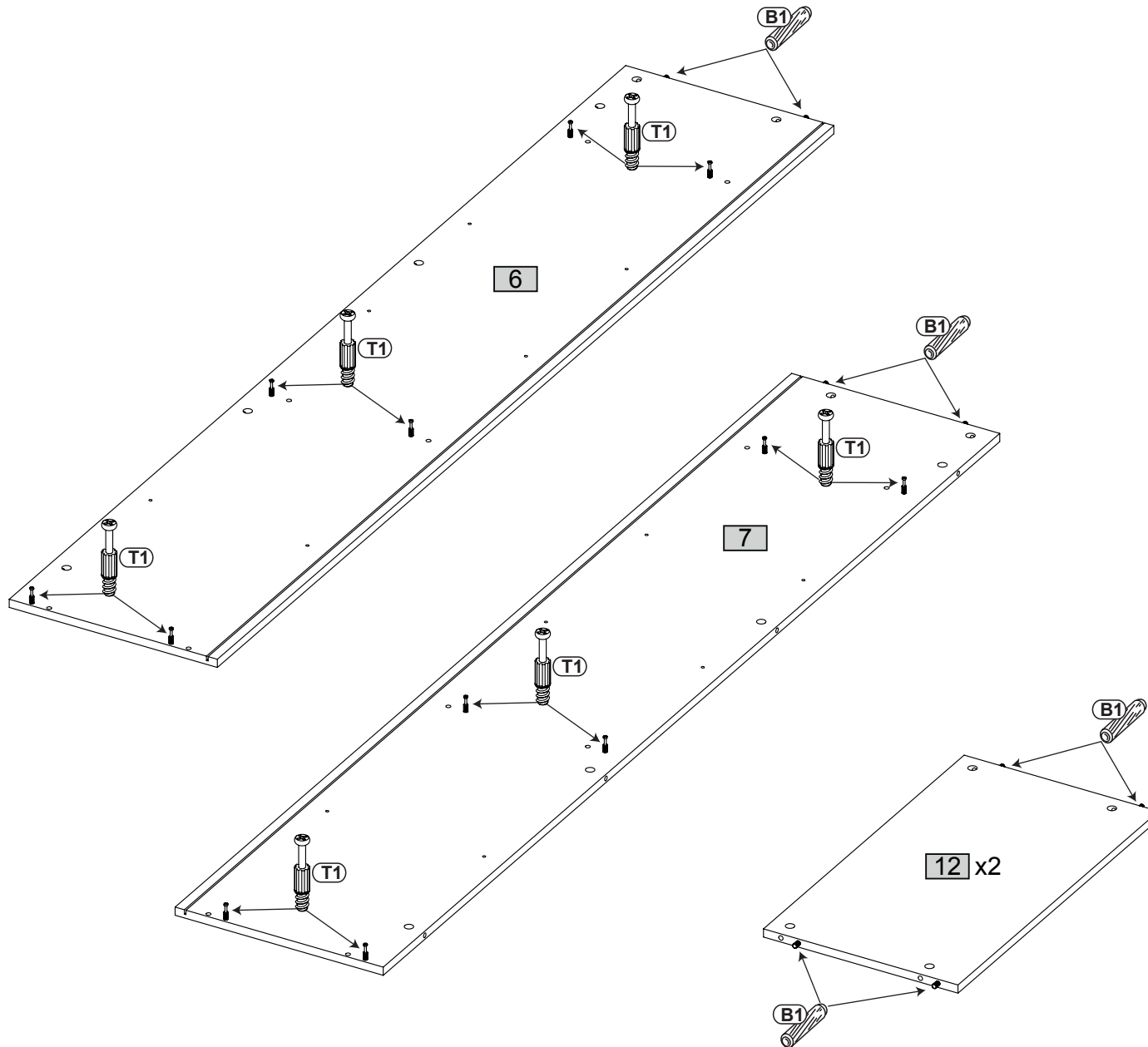
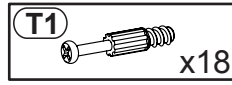
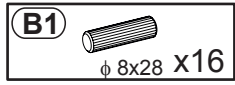

2L

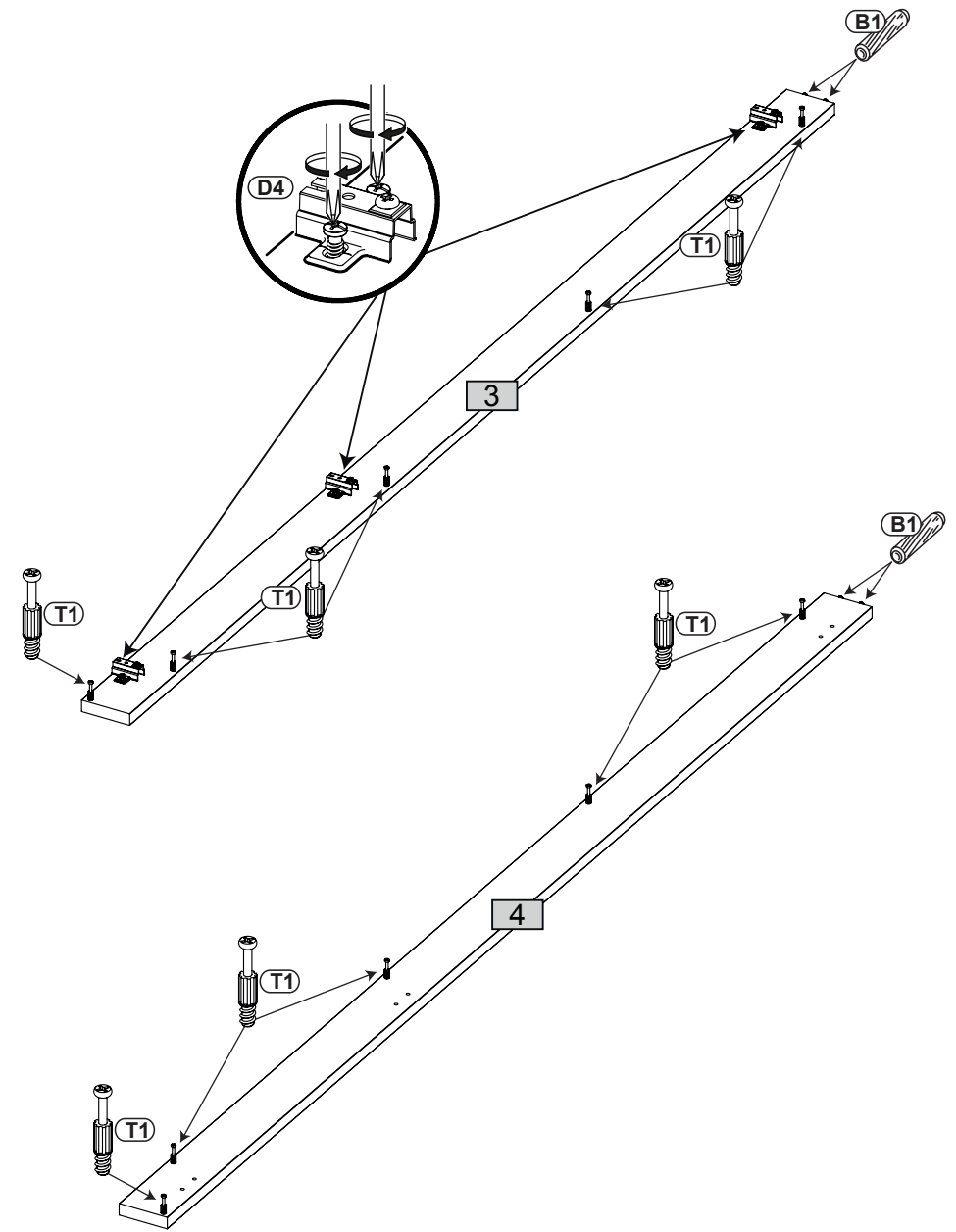
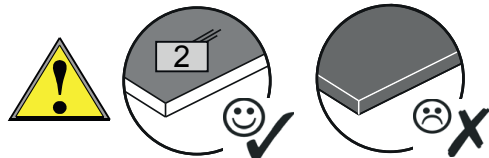
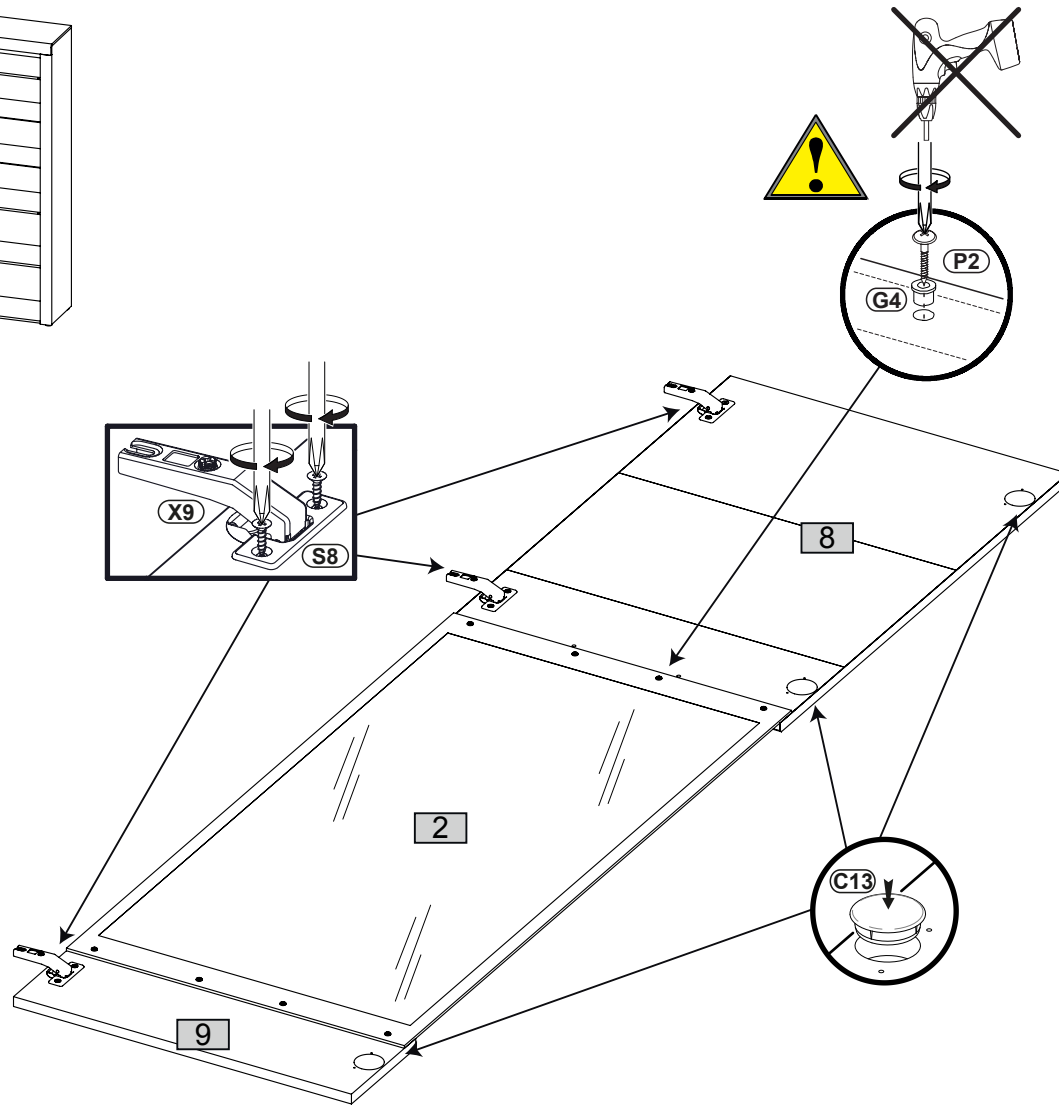
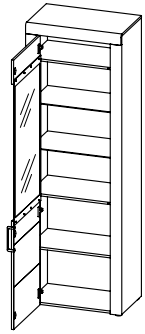
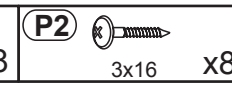
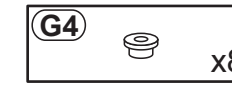
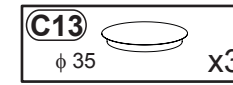
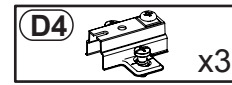
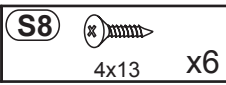
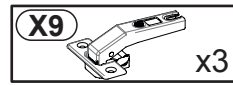
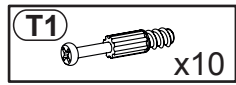
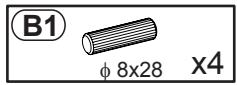

2P

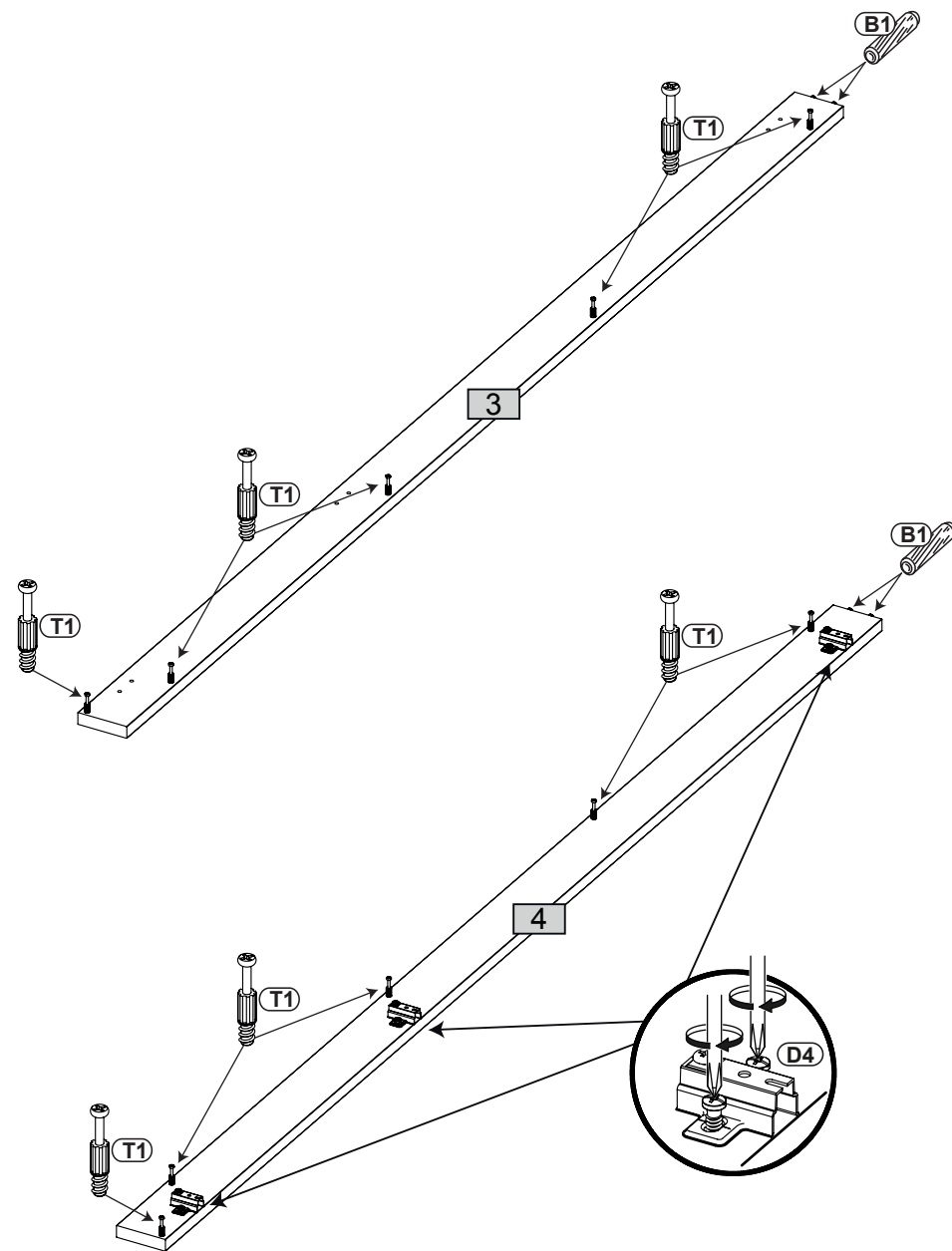
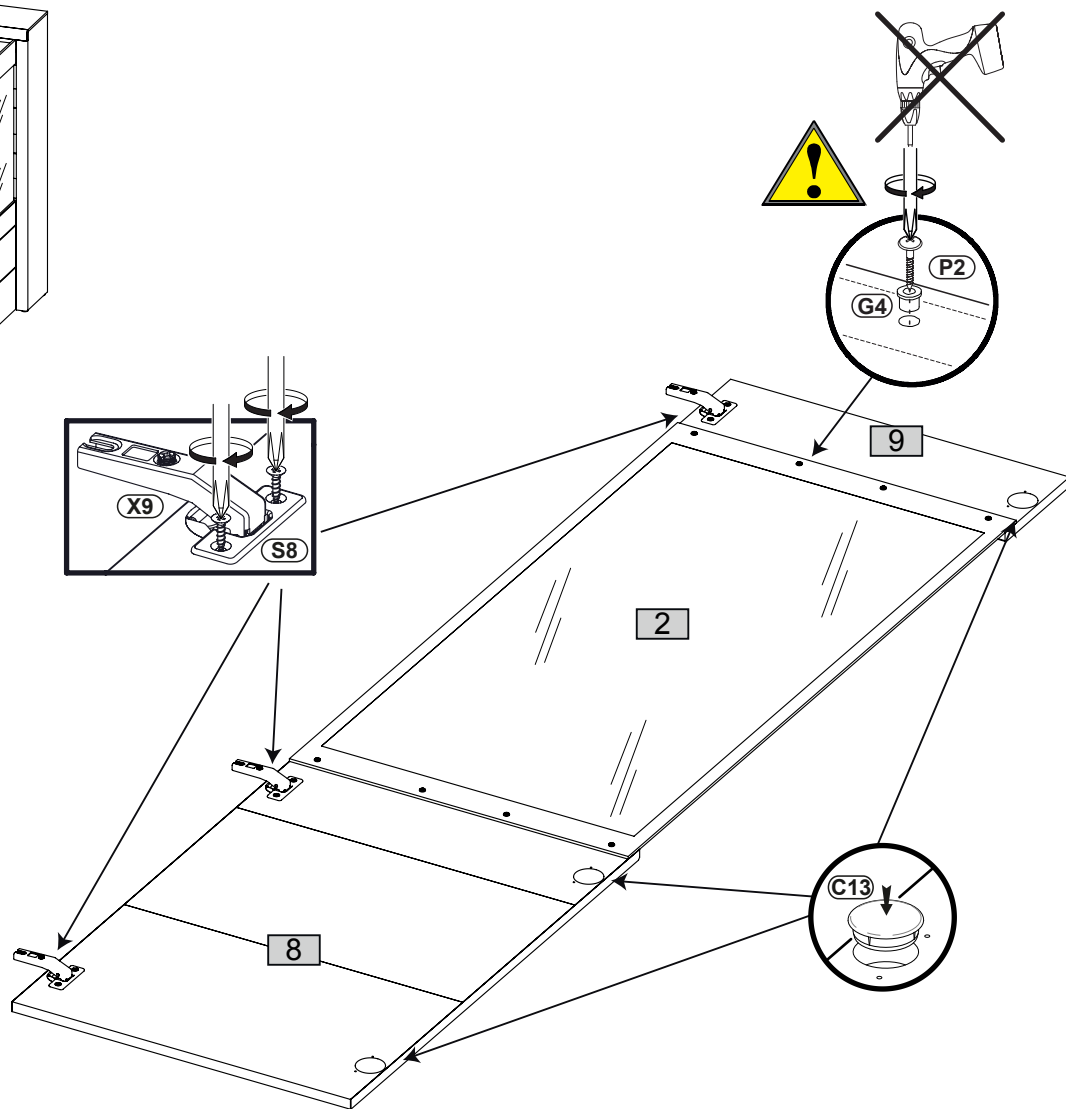
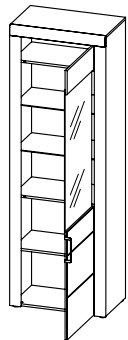
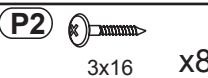
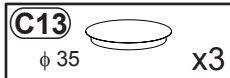
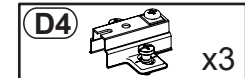
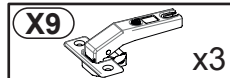
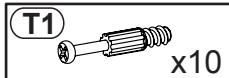
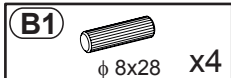

3

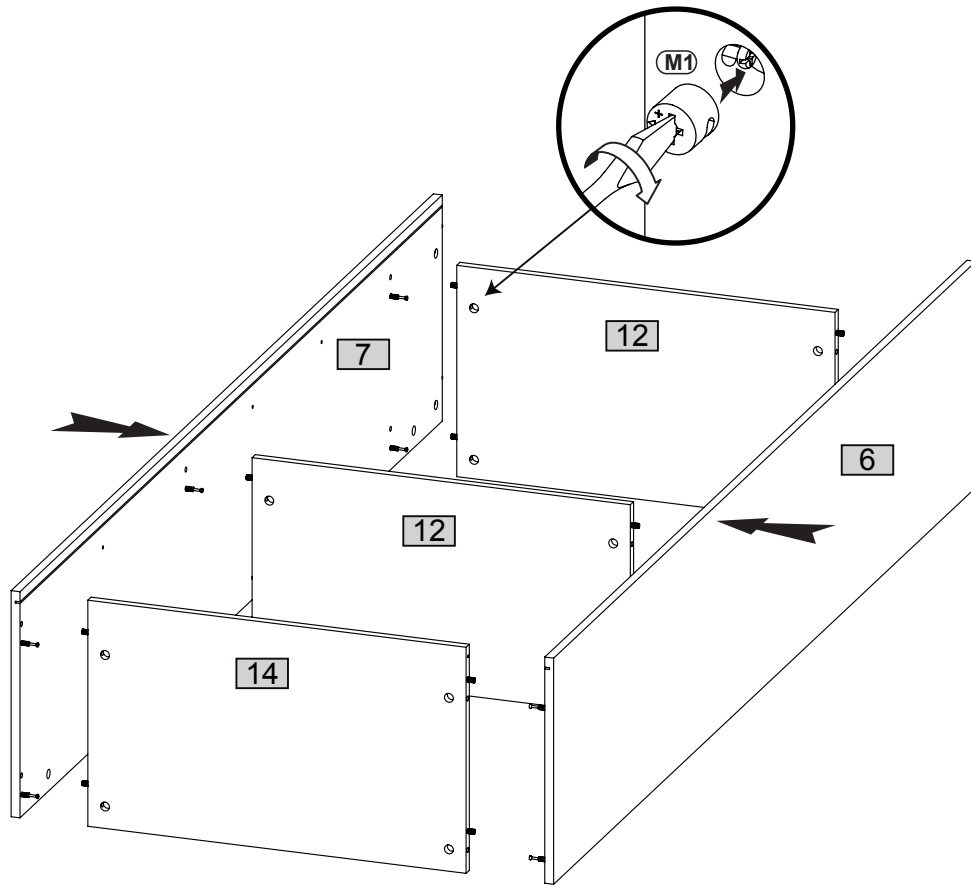

4

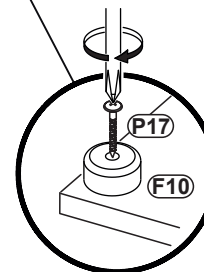
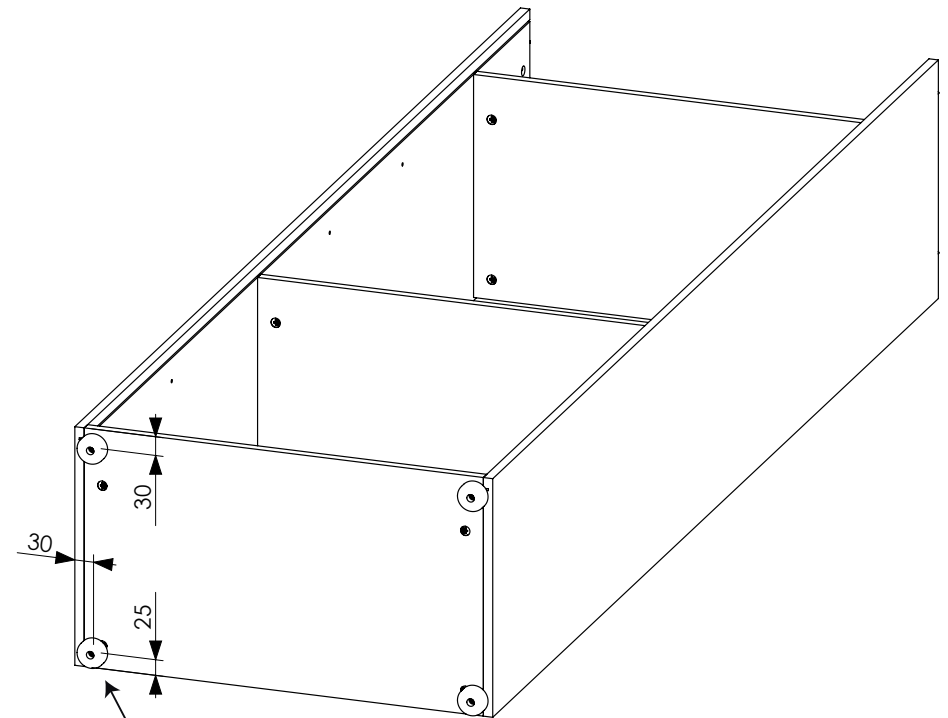
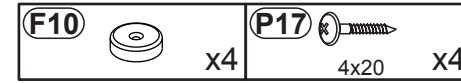

5

M1  x10

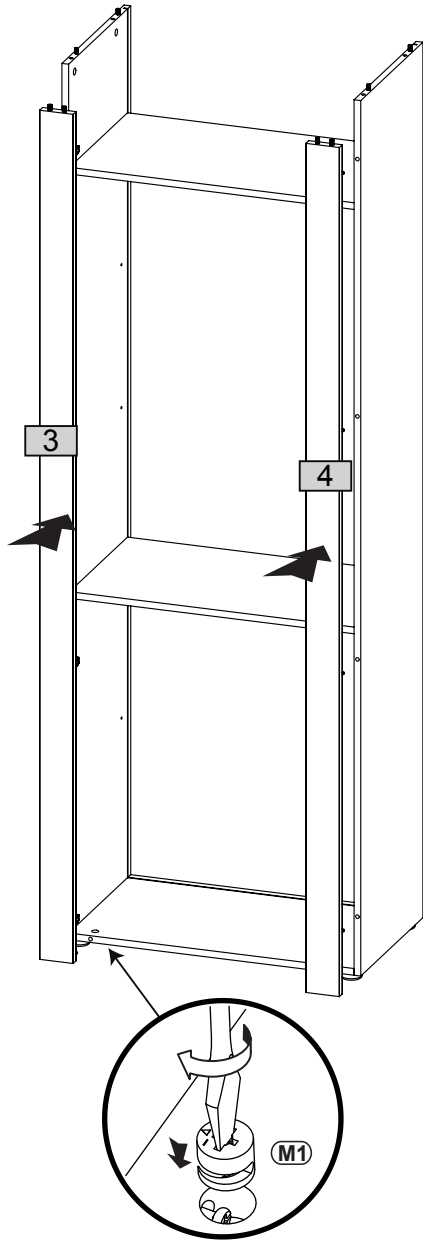

6

M1  x2

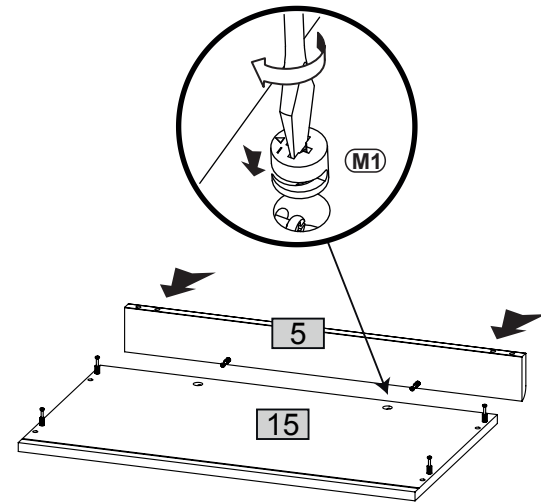

7

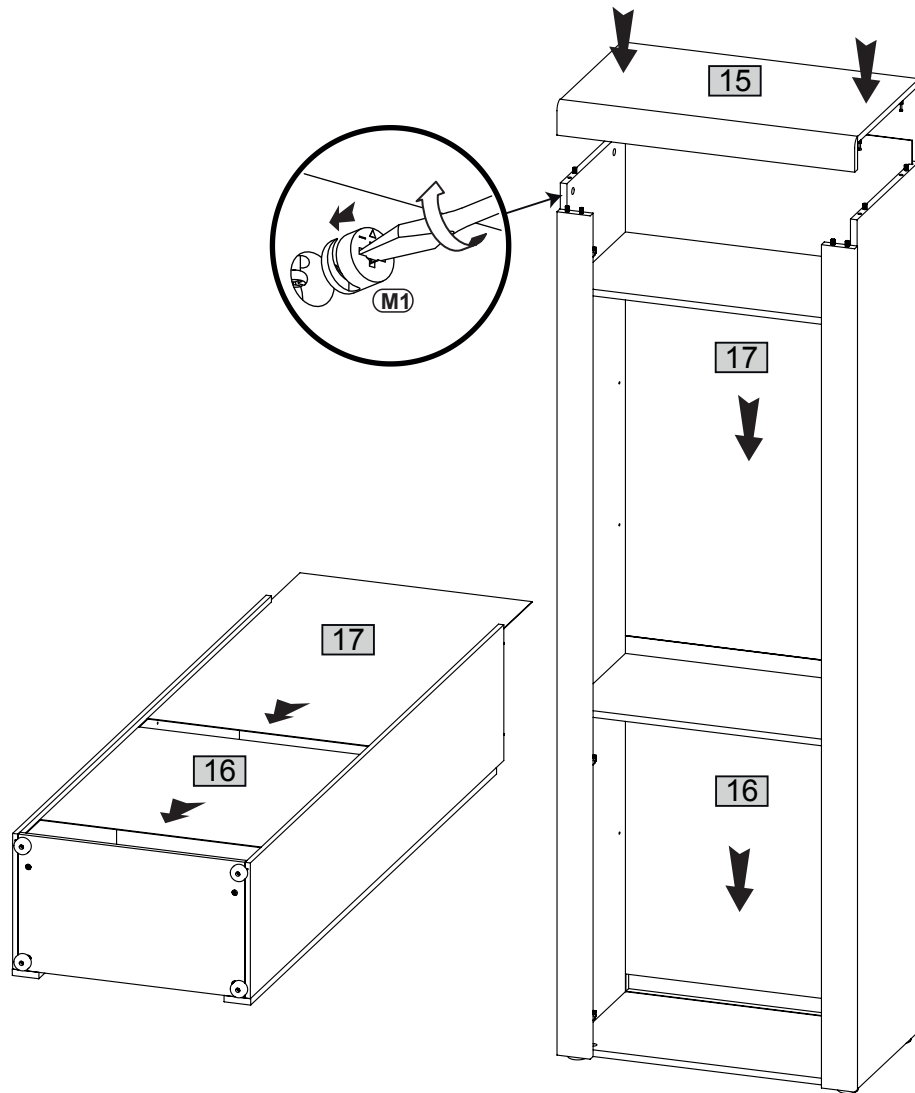

8

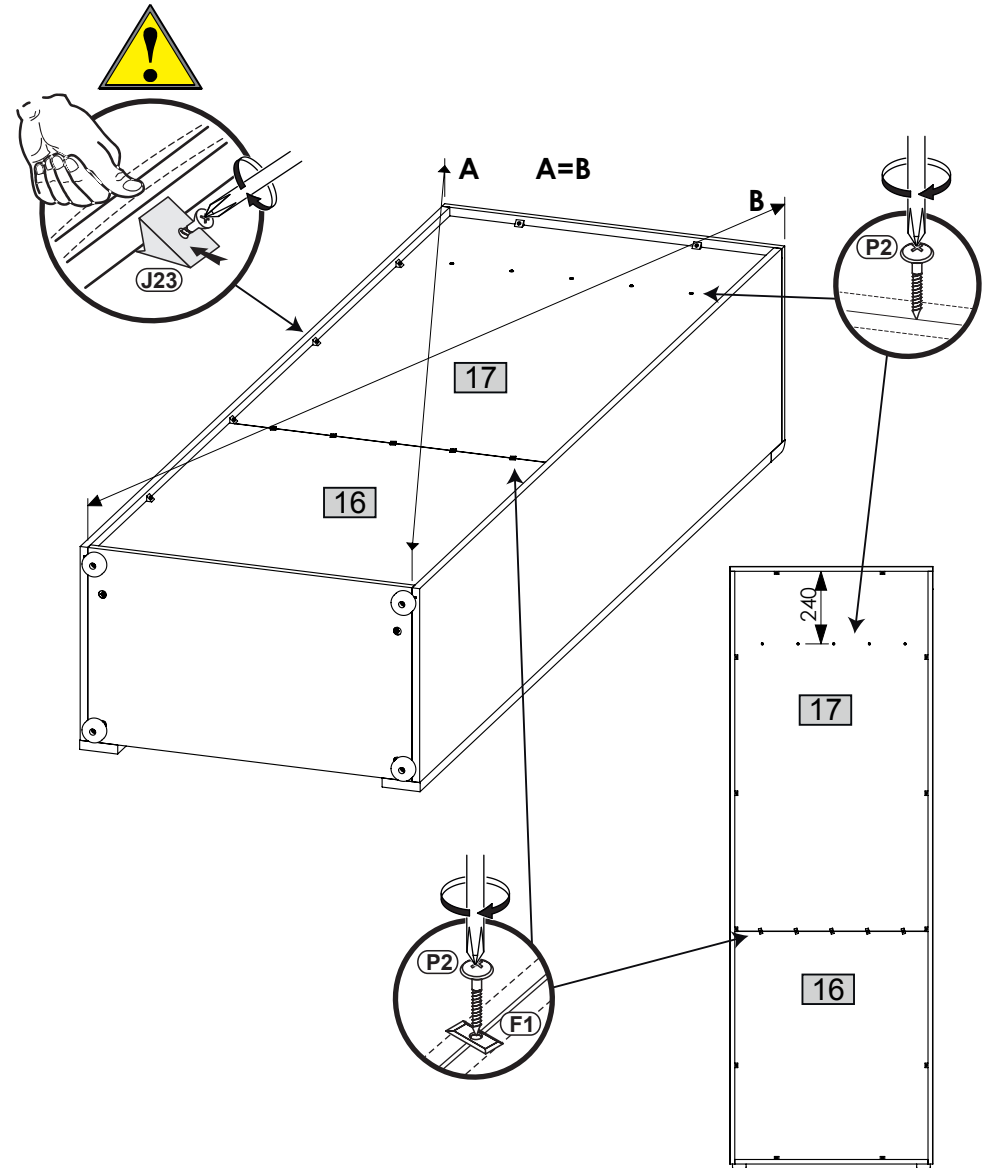
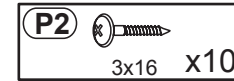
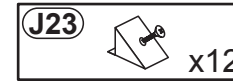

9L

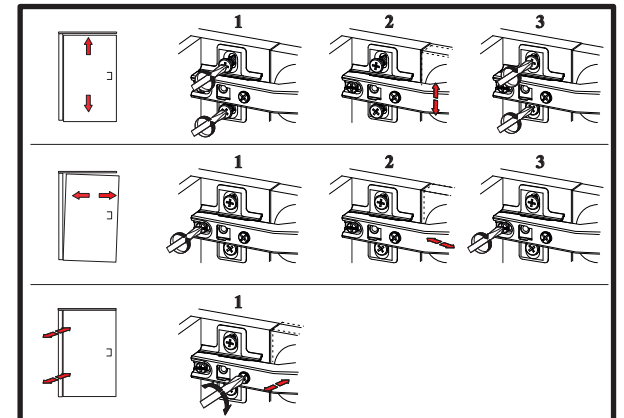
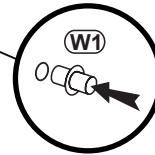
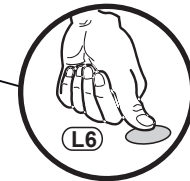
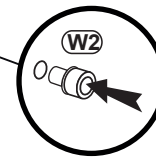
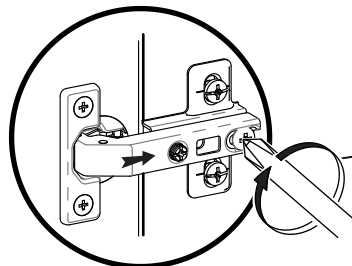
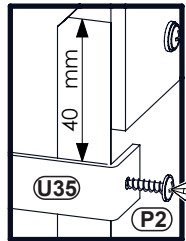
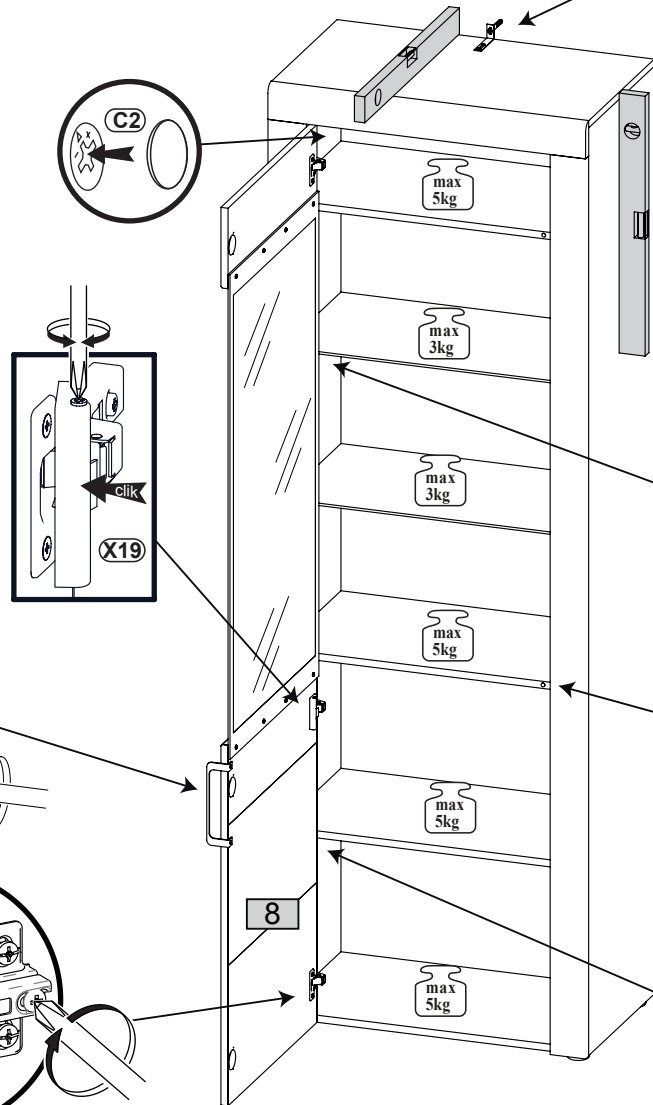
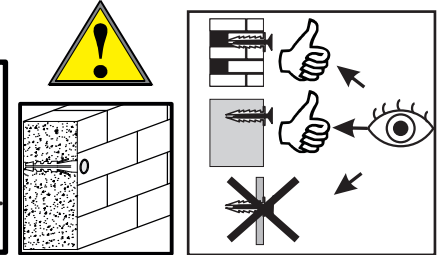
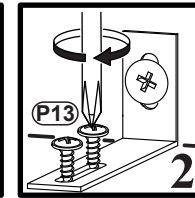
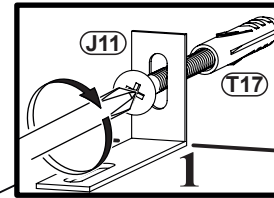
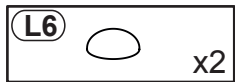
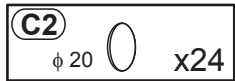
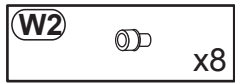
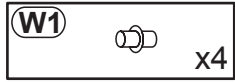
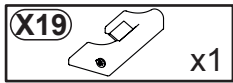
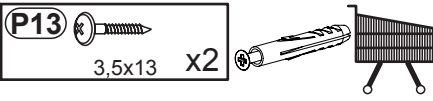
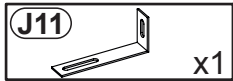
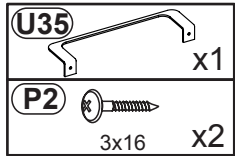

9P

