

# system VEGAS

## V-6

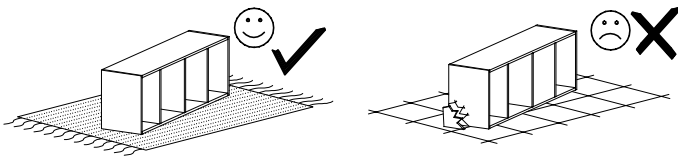

Narzędzia potrzebne do montażu

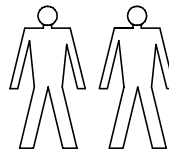
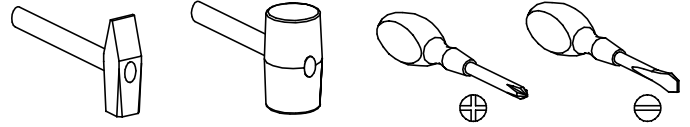

### UWAGA !!

MONTOWANIE USZKODZONYCH  
ELEMENTÓW POWODUJE UTRATĘ  
GWARANCJI

nr	D[mm]	S[mm]	G[mm]	Ilość
1	1278	407	48	1
2	1278	407	48	1
3	780	405	48	1
4	780	388	16	1
5	780	388	16	1
6	780	405	48	1
7	393	320	16	2
8	417	320	16	1
9	1268	417	2,5	2
10	576	430	16	1
11	390	355	2,5	1
12	430	190	16	1
13	350	165	16	1
14	350	165	16	1
15	360	165	16	1
16	770	368	16	1
17	770	368	16	1

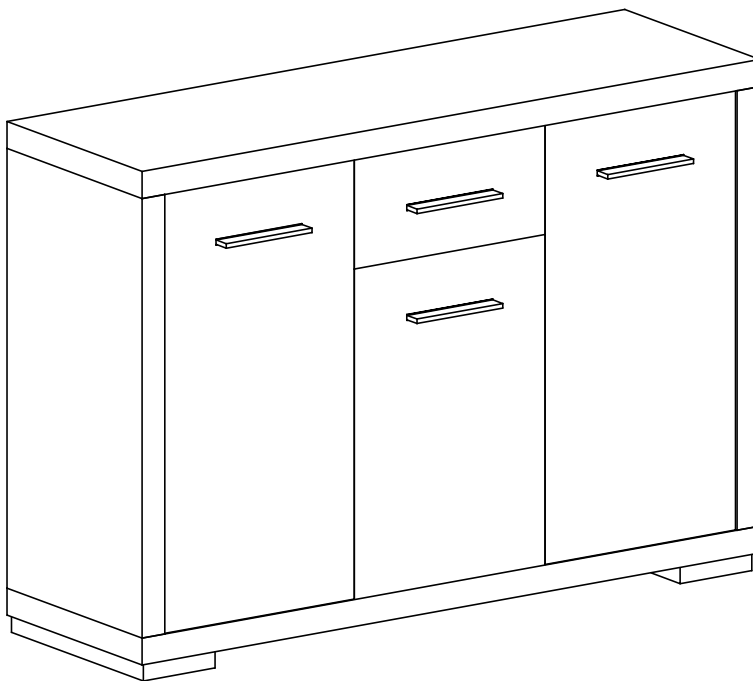

W przypadku reklamacji proszę o podanie numeru pakowacza znajdującego się na kartonie

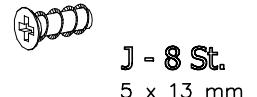
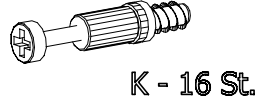
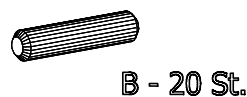
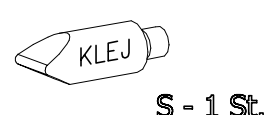
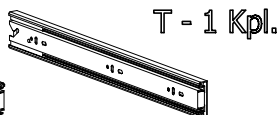
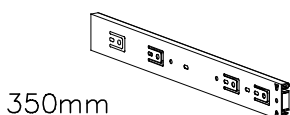
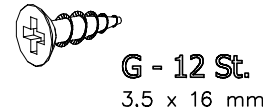
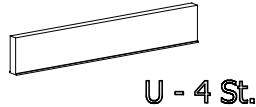
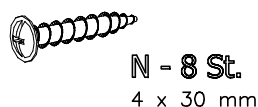
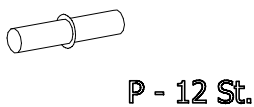
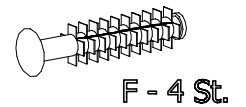
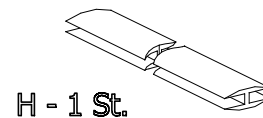
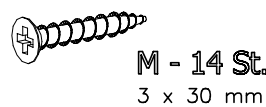
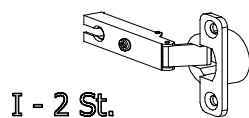

I

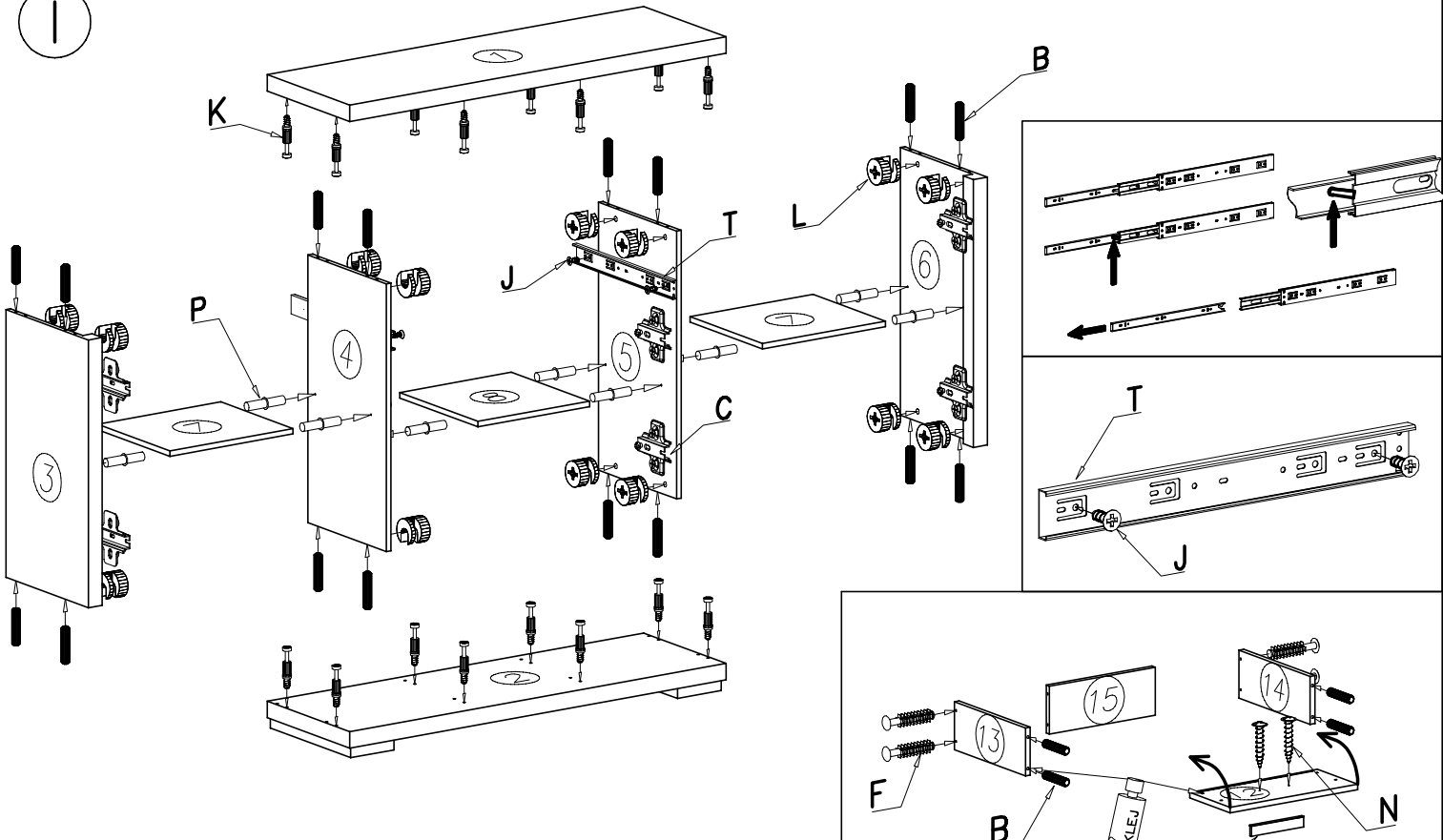

II

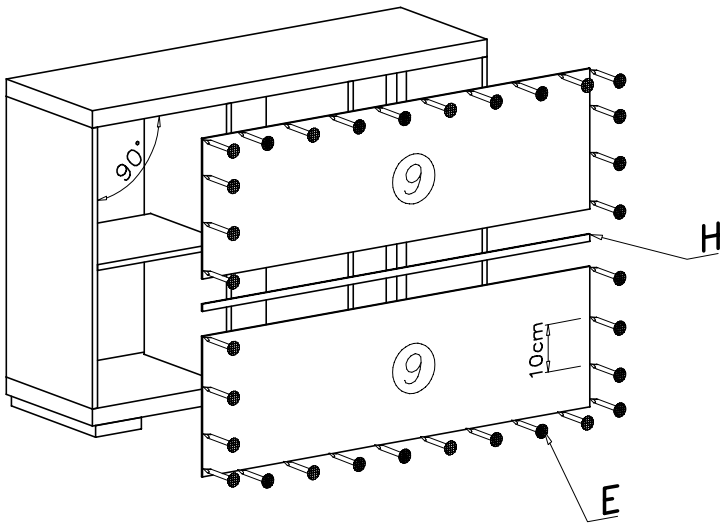

IV

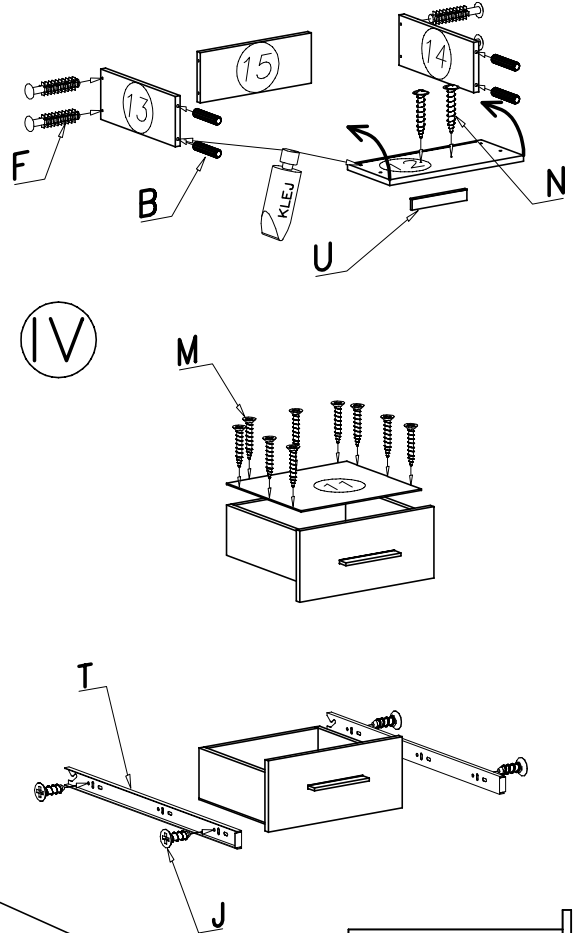

III

