

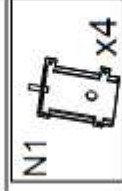

## Szafa - OLWIER

(szer. 100 cm , wys. 215cm, gl. 62cm )

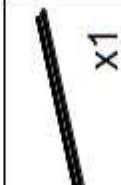
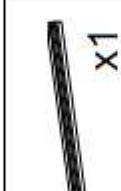
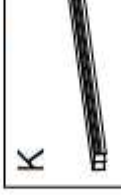
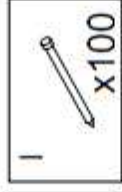
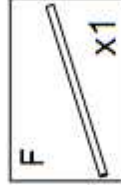
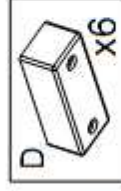
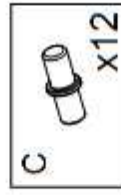
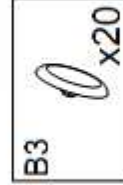
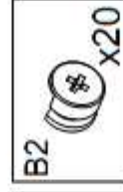
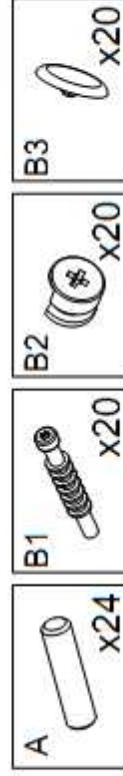
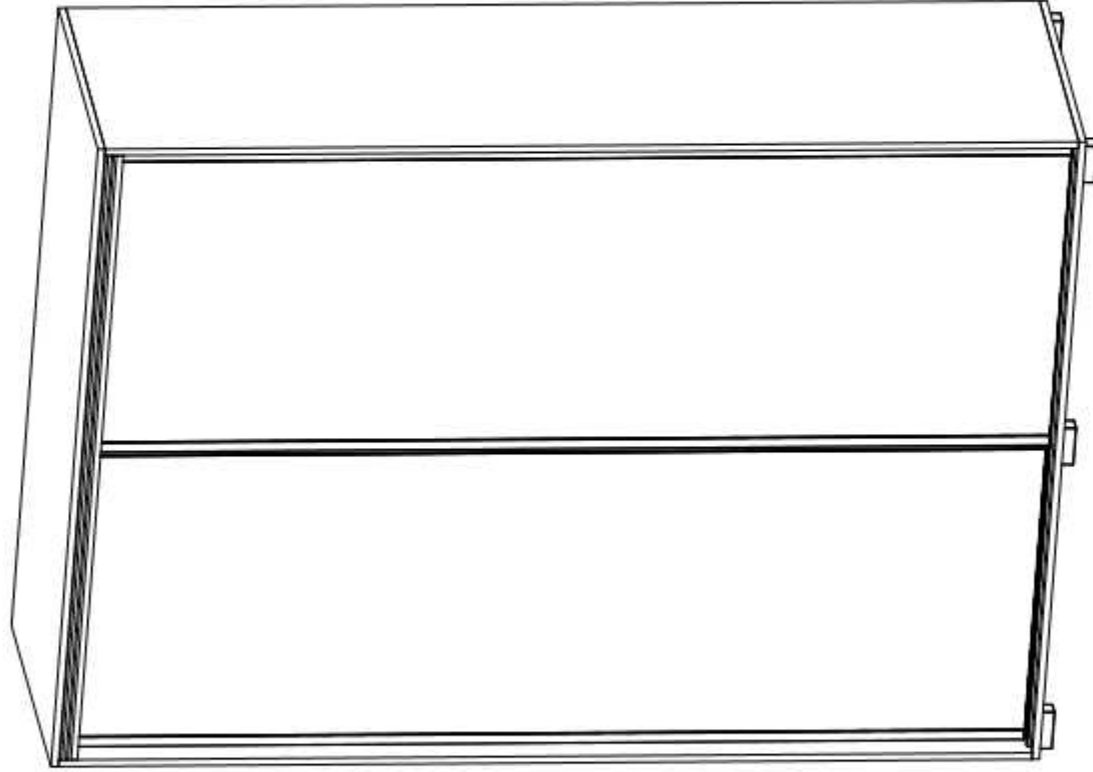

Oznaczenie elementu	Nazwa	Ilość	Wymiary	
			szer.	wys.
1	Bok lewy	1	610	2090
2	Przegroda środkowa	1	500	2090
3	Bok prawy	1	610	2090
4	Półka (wieniec)	2	500	476
5	Półka	3	500	476
6	Błat górny	1	620	1001
7	Błat dolny	1	620	1001
8	Tył (plecy)	4	527	995
9	Skrzydło drzwi	2	625	2053

# Instrukcja montaży



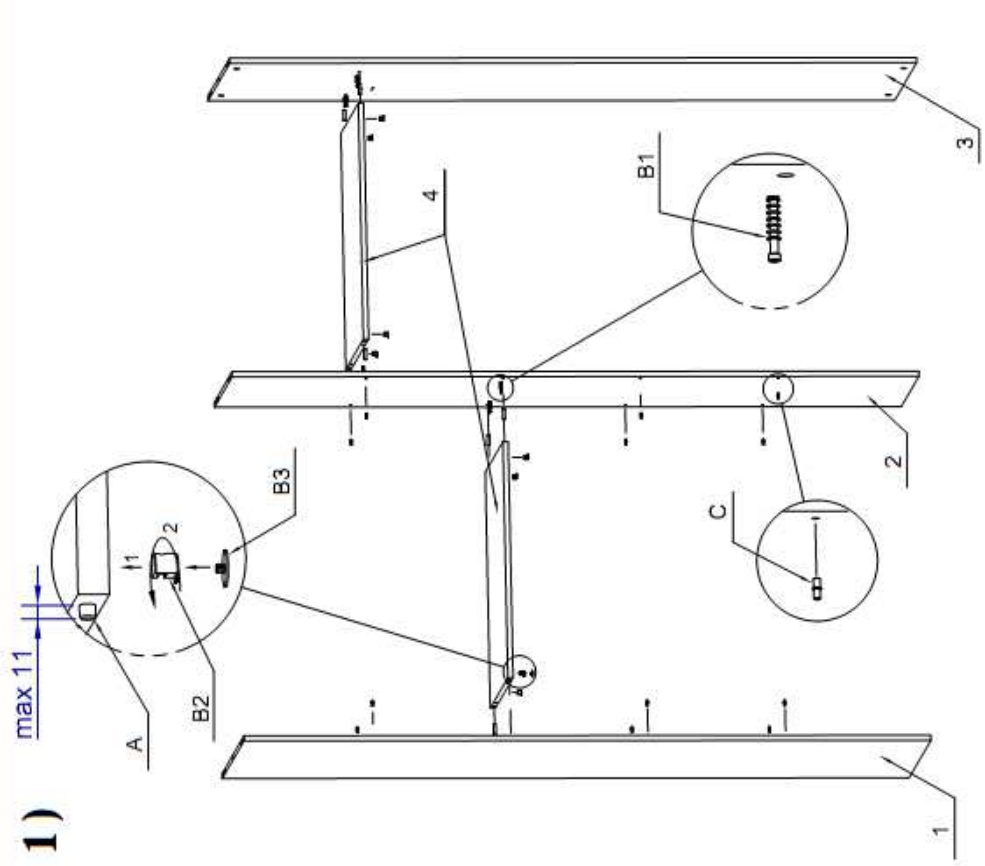



**1)**

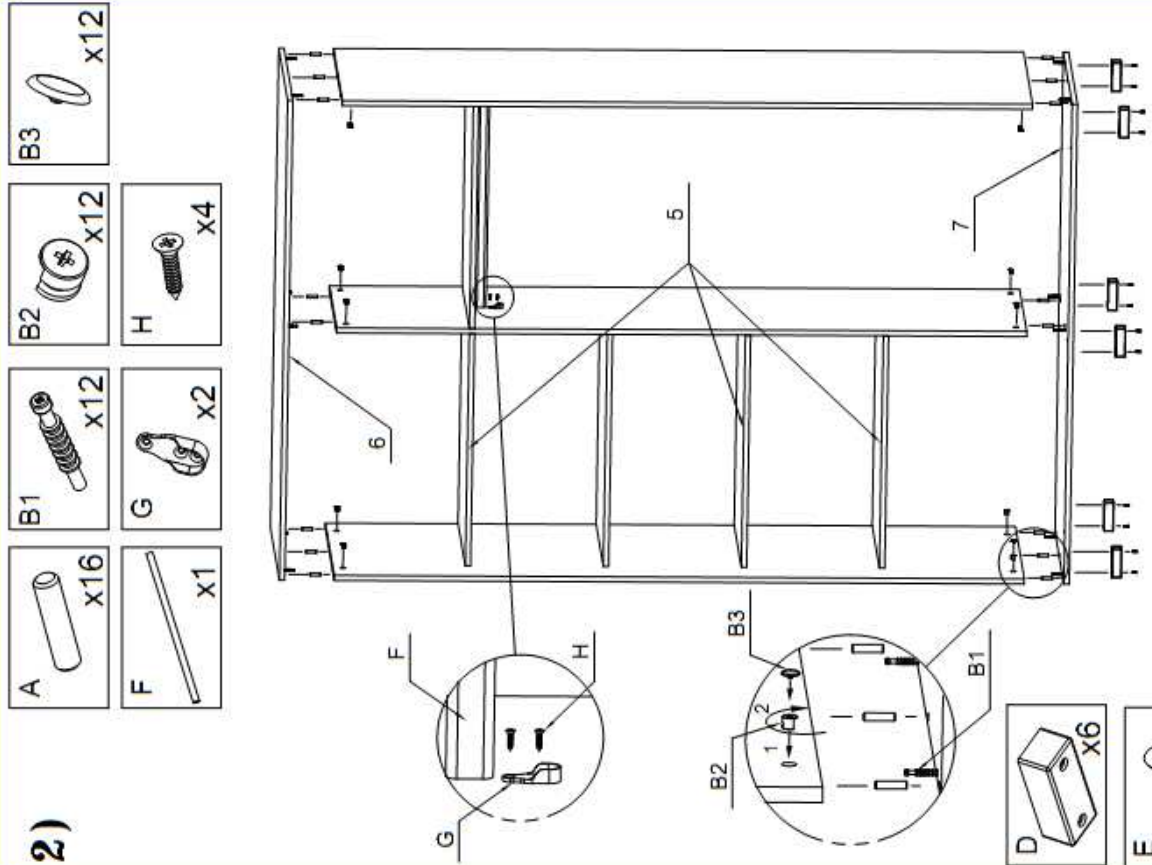



- A  x8
- B1  x8
- B2  x8
- B3  x8
- C  x12

**2)**



- A  x16
- B1  x12
- B2  x12
- B3  x12
- F  x1
- G  x2
- H  x4

- D  x6
- E  x12

## Instrukcja montażu

3)

Prowadnica górna powinna być zamontowana równo z bokami szafy

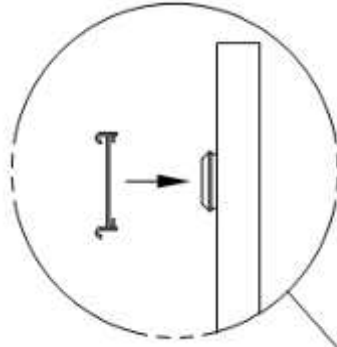
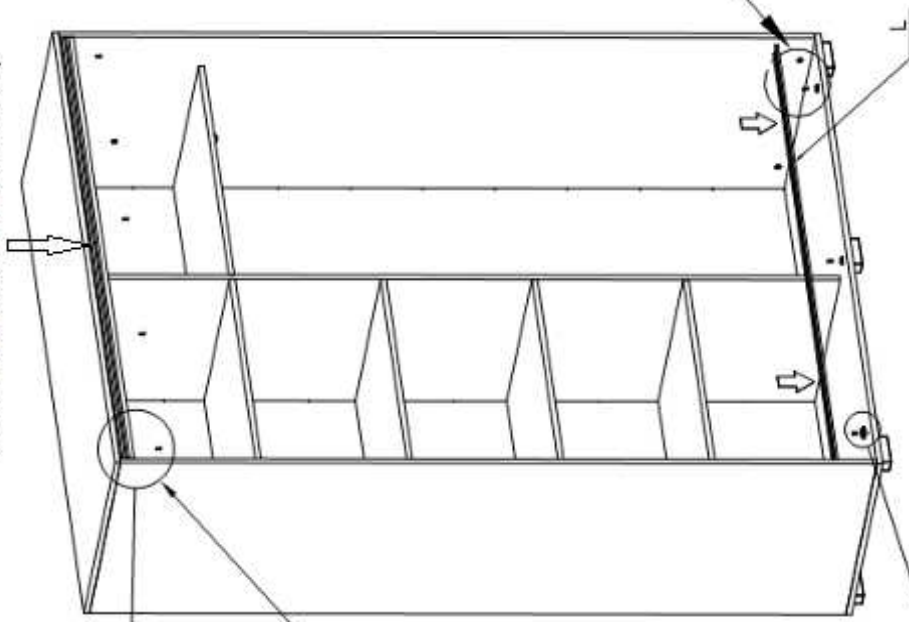
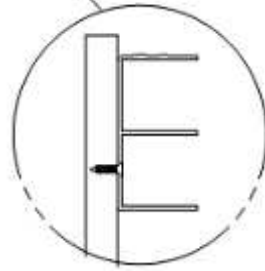
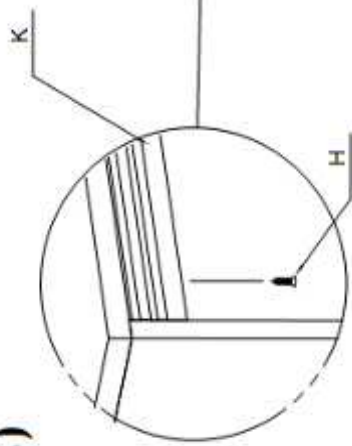

# Instrukcja montażu

**4)** (Widok od tyłu)

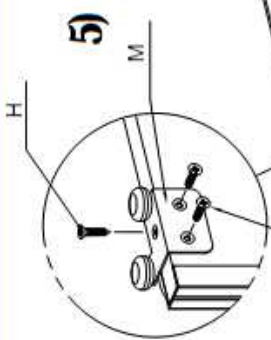
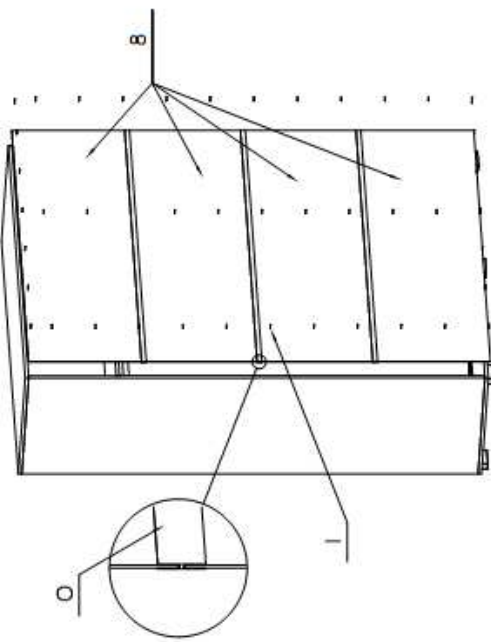

**5)** (Widok drzwi od tyłu)

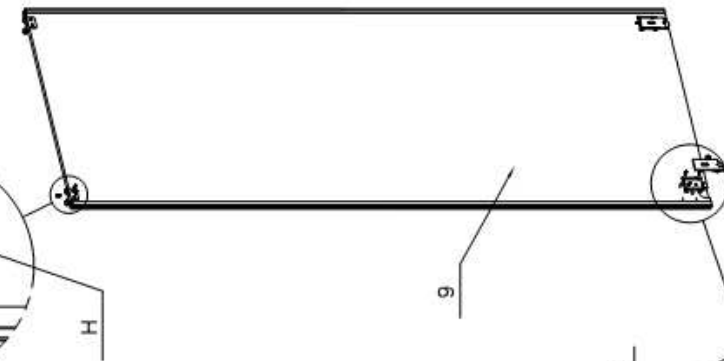

**6)**

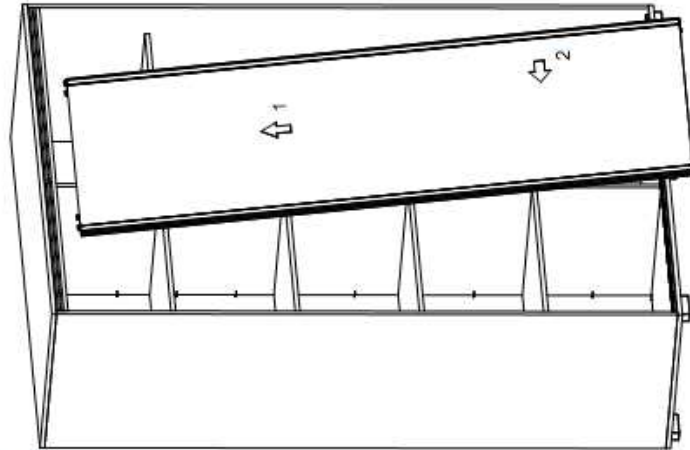

Rolke wózka dolnego dokreć po osadzeniu skrzydła drzwiowego w szafie

