

PRZED ROZPOCZĘCIEM MONTAŻU ZAPOZNAĆ SIĘ Z INSTRUKCJĄ

Narzędzia niezbędne do montażu (nie dostarczane przez producenta)

GRANT Szafa

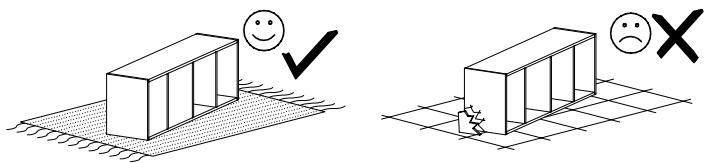

MONTOWAĆ NA MIEKKIM PODŁOŻU TYPU: KOC, DYWAN.

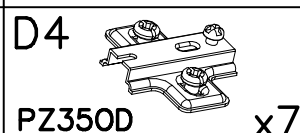
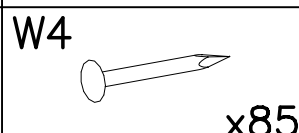
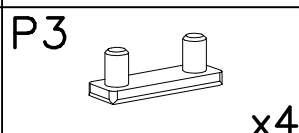
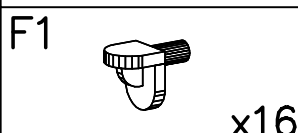
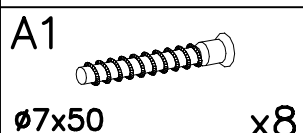
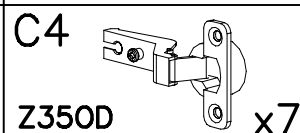
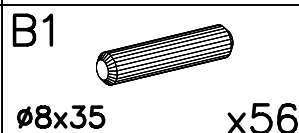
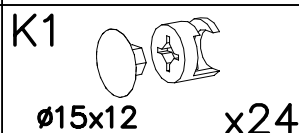
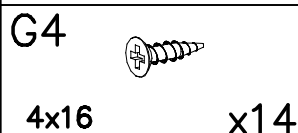
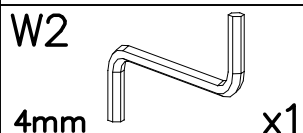
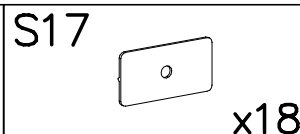
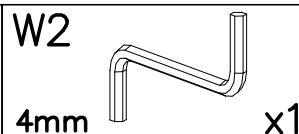
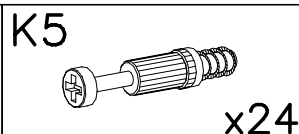
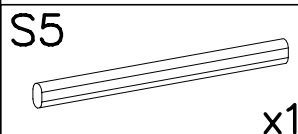
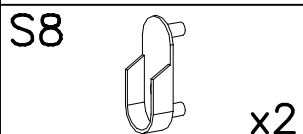
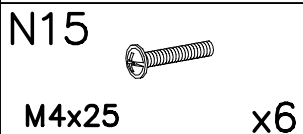
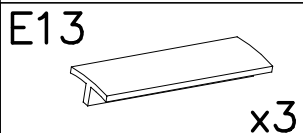
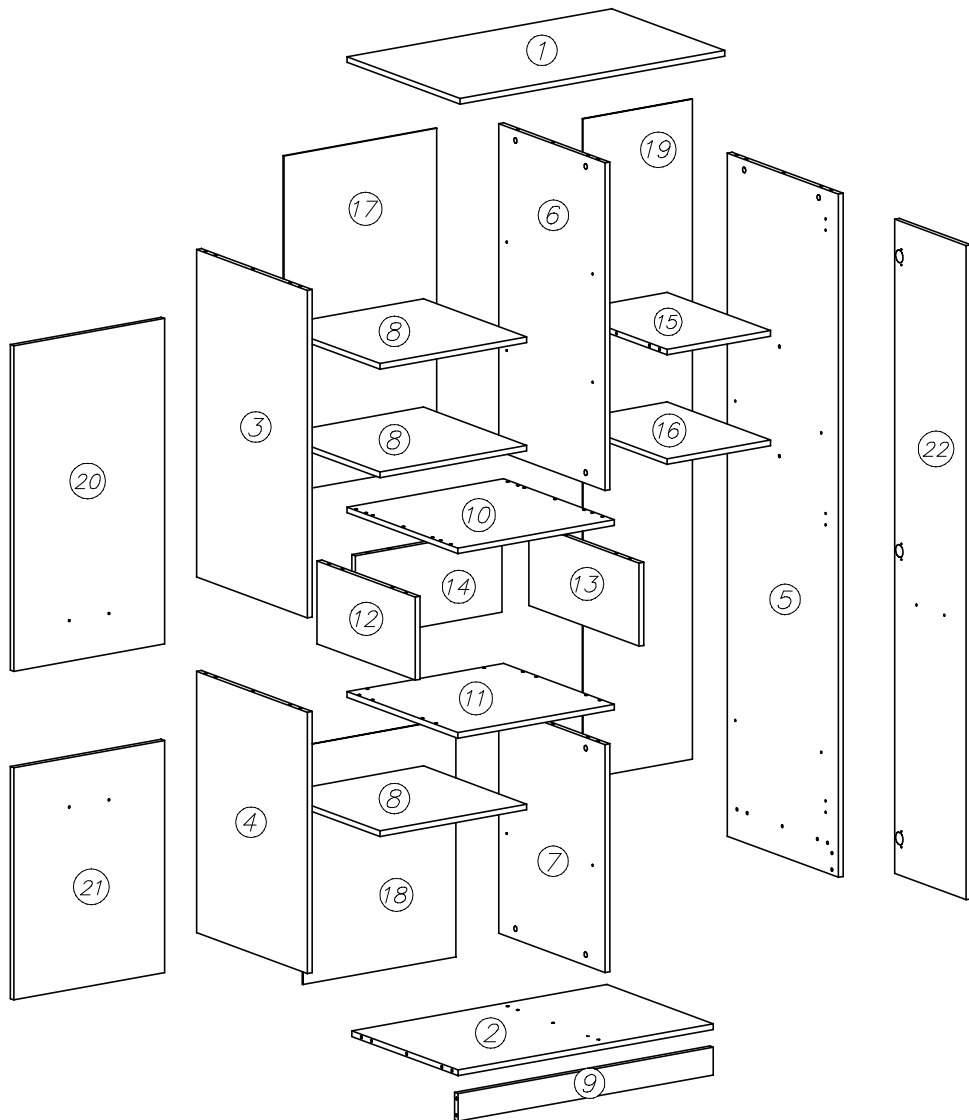
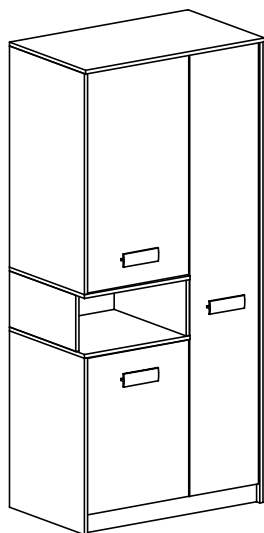
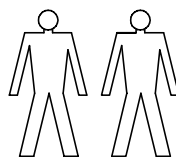
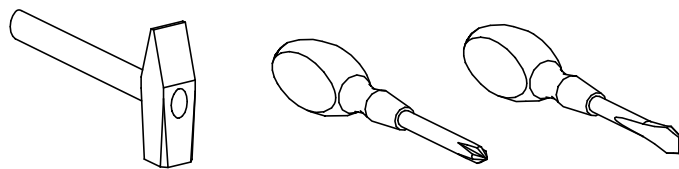

1

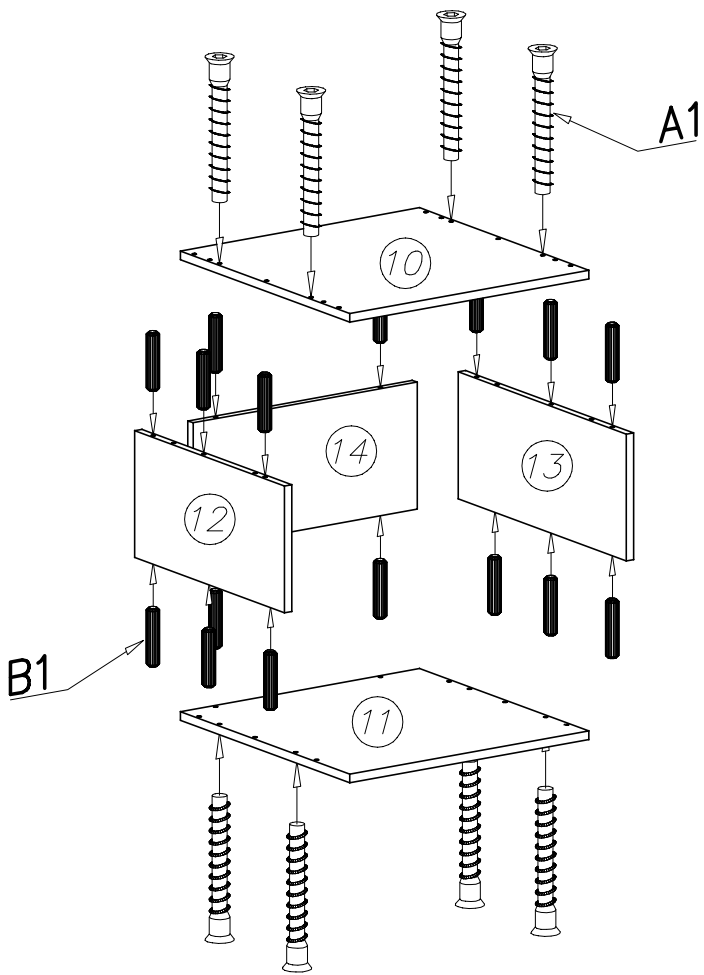

2

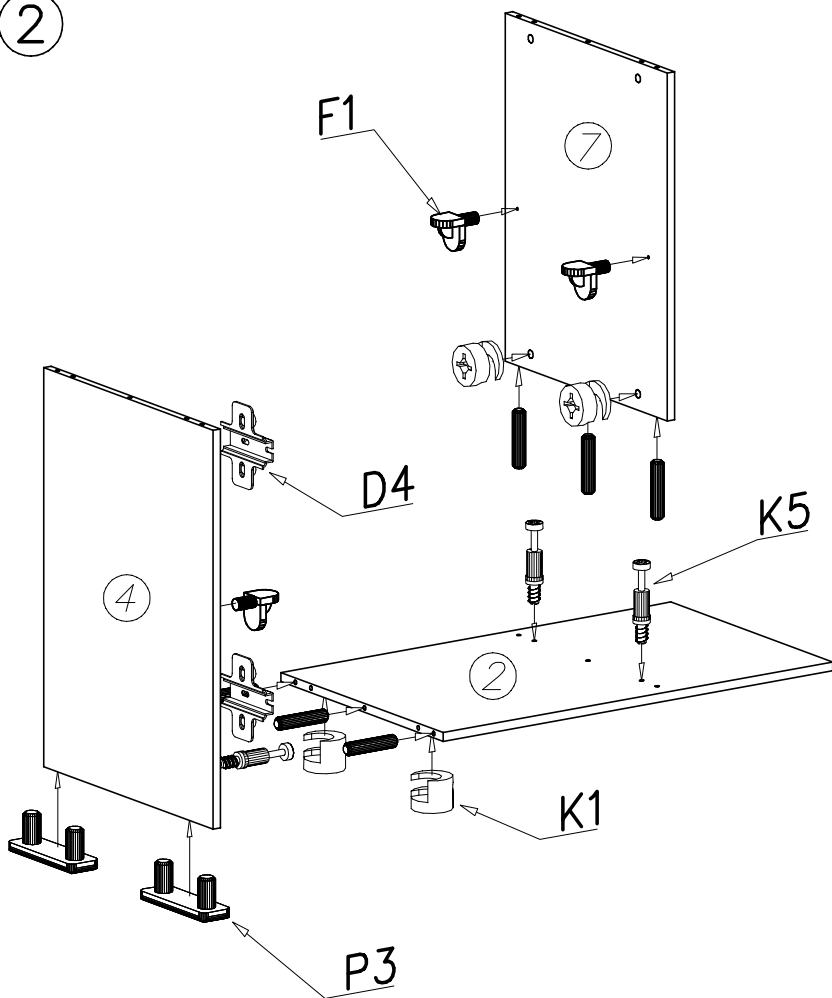

3

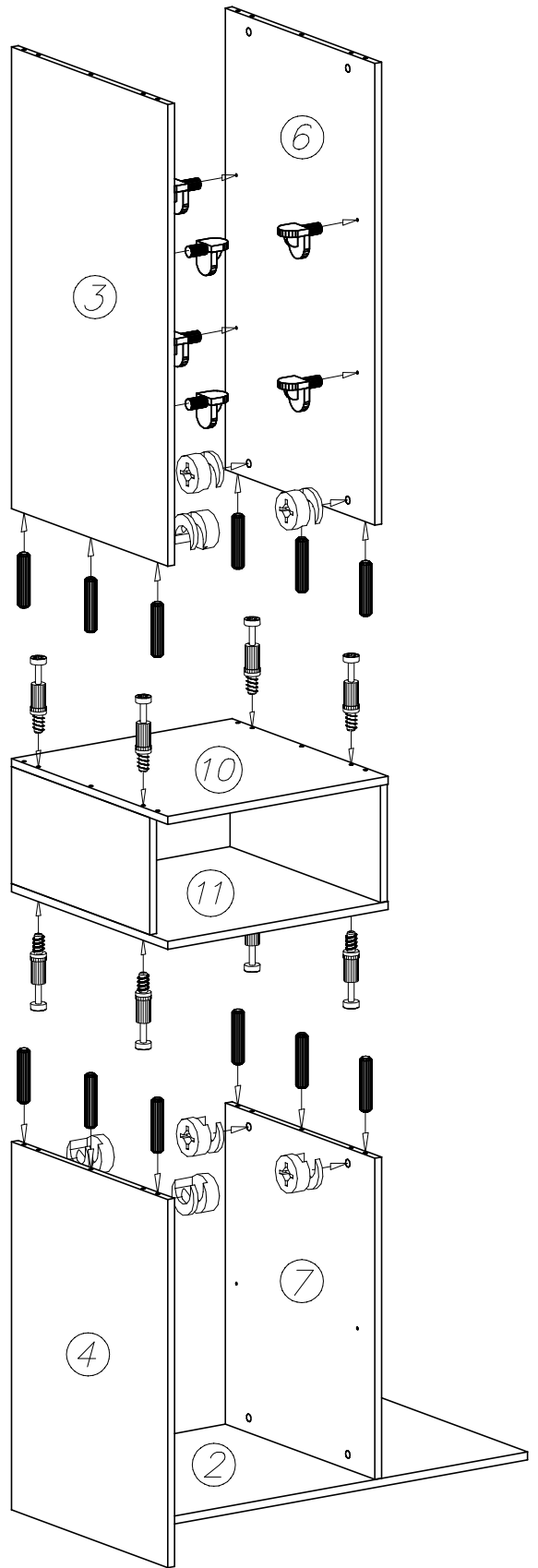

4

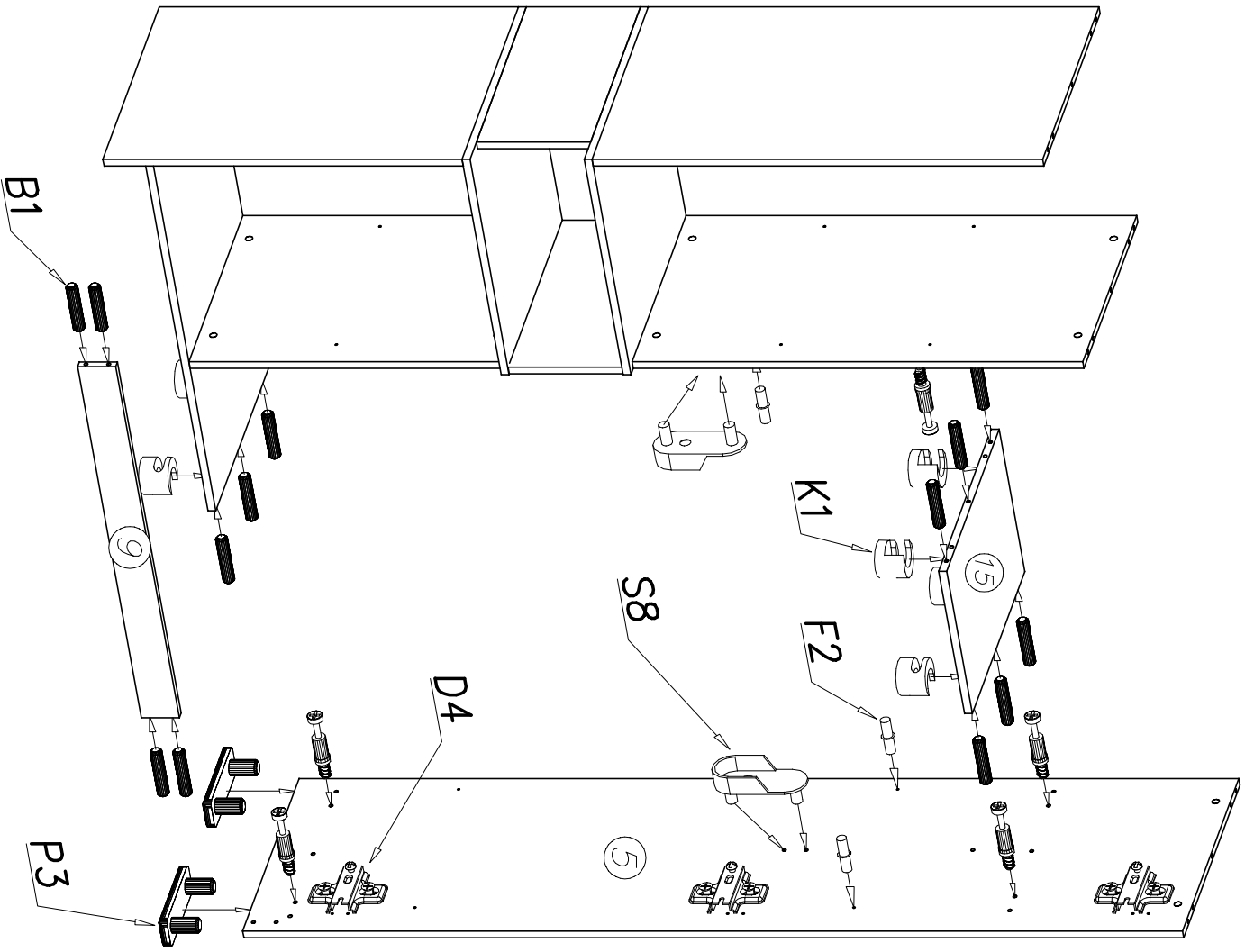

5

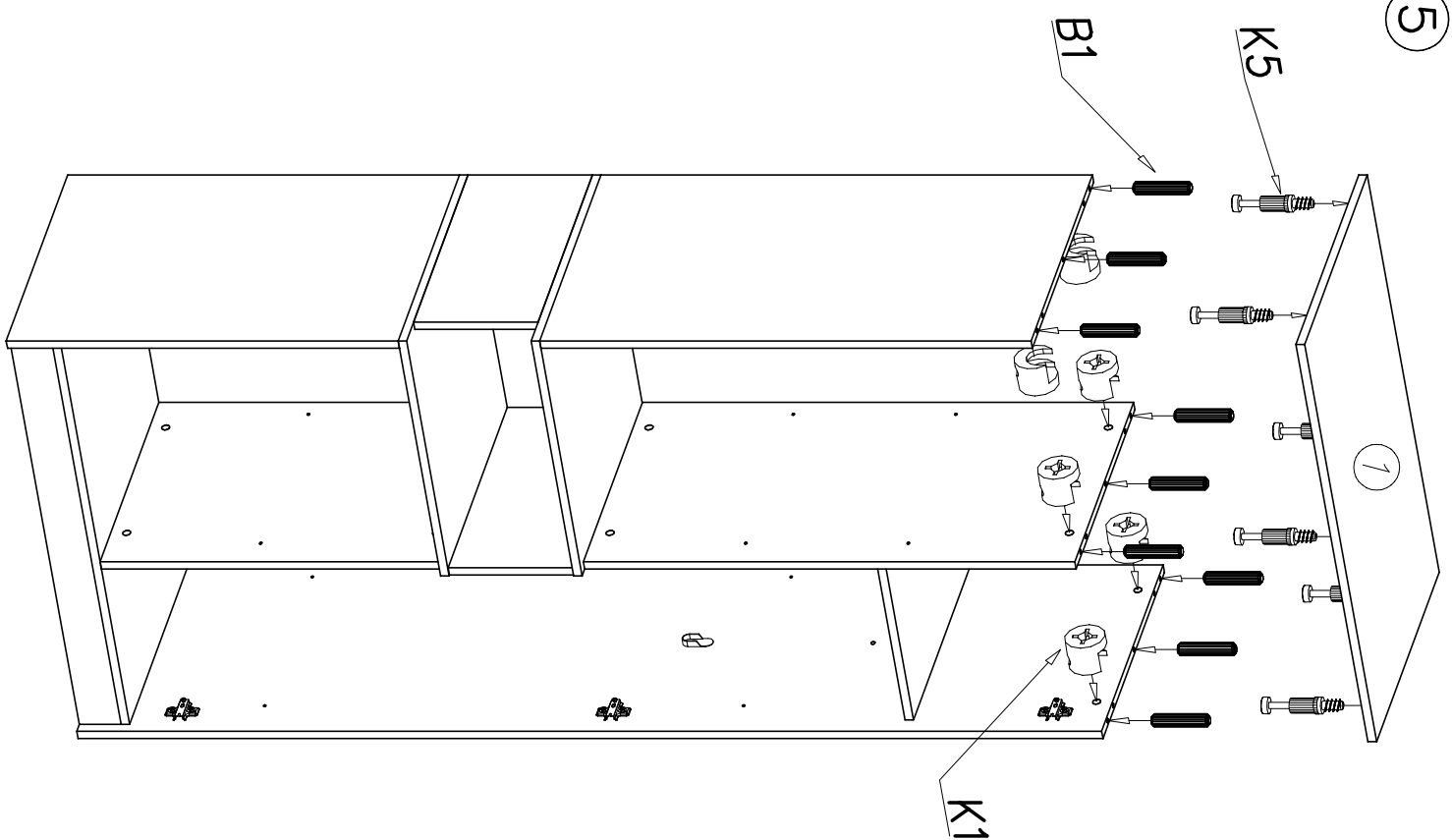

6

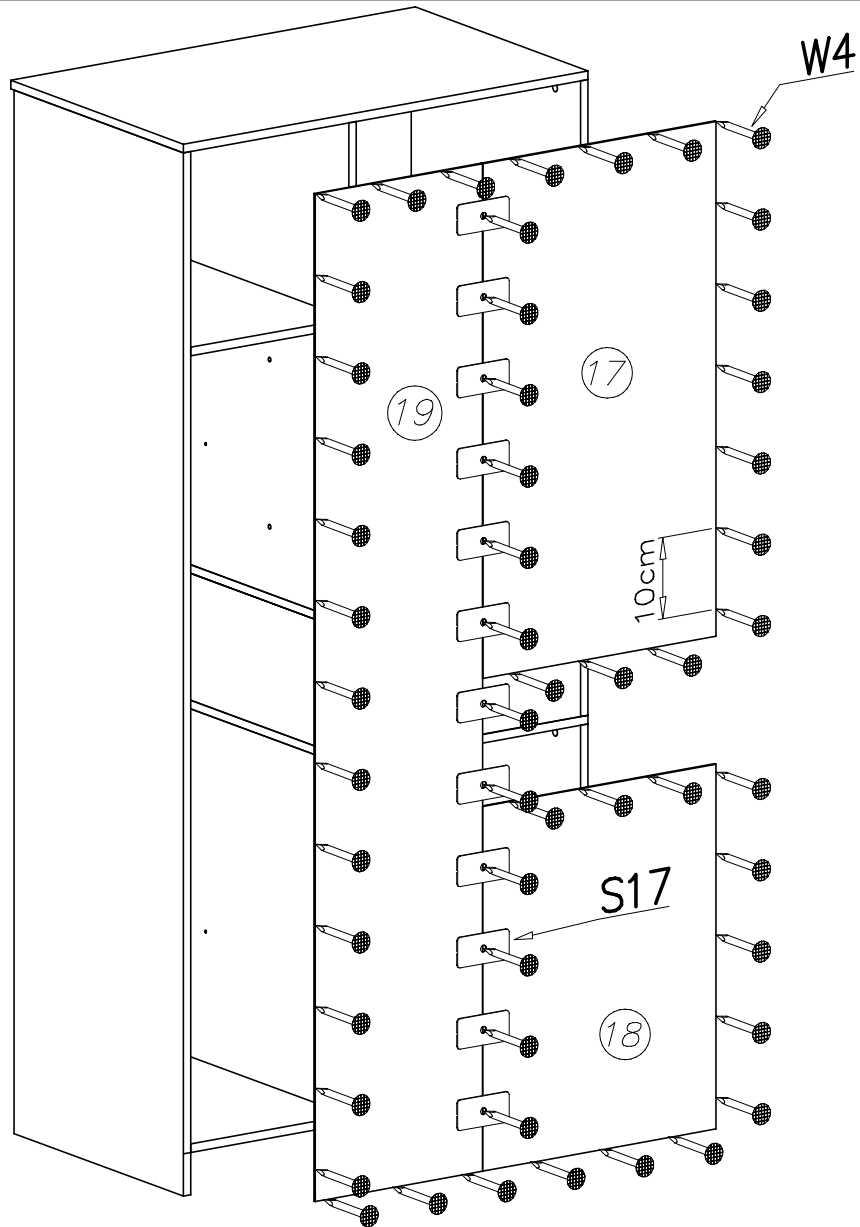

7

